

NASA

NATIONAL AERONAUTICS AND SPACE ADMINISTRATION

FINAL

# APOLLO 9 FLIGHT PLAN

AS-504/CSM-104/LM-3

FEBRUARY 3, 1969

PREPARED BY

FLIGHT PLANNING BRANCH  
FLIGHT CREW SUPPORT DIVISION

N71-20513

(ACCESSION NUMBER)

(THRU)

H1

(COL)

30

(CATEGORY)

378

(PAGES)

TMX-66904

(NASA OR AF MX OR AD NUMBER)

FACILITY FORM 602

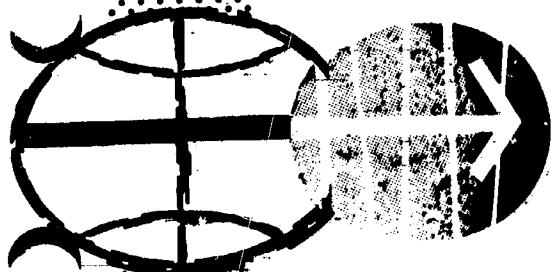

MANNED SPACECRAFT CENTER  
HOUSTON, TEXAS

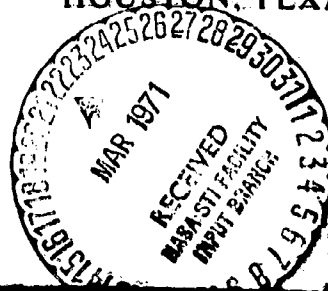

APOLLO 9  
APOLLO AS504/104/LM-3  
FINAL FLIGHT PLAN

FEBRUARY 3, 1969

Submitted by: J. V. Rivers  
J. V. Rivers  
Flight Planning Branch

A. H. Gardner  
S. H. Gardner  
Flight Planning Branch

Approved by: W. J. North  
W. J. North  
Chief, Flight Crew Support Division

Donald K. Slayton  
Donald K. Slayton  
Director of Flight Crew Operations

Concurrence: George M. Low  
George M. Low  
Manager, Apollo Spacecraft Program

Concurrence: Christopher C. Kraft, Jr.  
Christopher C. Kraft, Jr.  
Director of Flight Operations

Any comments or questions on this document should be forwarded to J. V. Rivers or S. H. Gardner, Flight Planning Branch, mail code CF34, extension 4271.

## TABLE OF CONTENTS

	<u>Page</u>
Introduction	
Abbreviations	
<u>Section 1 General</u>	
1. Flight Plan Description	1-1
2. Flight Plan Notes	1-17
<u>Section 2 - Update Pads</u>	
1. CSM	
Block Data	2-1
P27 Update	2-3
Nav Check	2-5
Maneuver Update	2-7
Entry Update and Postburn Update	2-10
Star Check Update	2-13
Landmark Tracking Update	2-15
S065 Update	2-17
Consumables Update	2-19
2. LM	
AOT Star Observation	2-21
S-Band Steerable Update	2-22
Maneuver Update	2-23
CSI Maneuver Update	2-26
CDH Maneuver Update	2-28
TPI Manuever Update	2-30
P27 Update	2-32
AGS State Vector Update	2-34
Gimbal Angle Update*	2-36
<u>Section 3 - Detailed Timeline</u>	
1. Summary Flight Plan	3-i
2. Burn Schedule	3-ii
3. Launch	3-1
4. S-IVB Orbital Operations	3-3
5. Docked Orbital Activites	
SPS Burn No. 1	3-6
SPS Burn No. 2	3-14
SPS Burn No. 3	3-15
SPS Burn No. 4	3-17
6. LM Systems Evaluation	
LM Activation	3-24
Docked DPS Burn	3-31
SPS Burn No. 5	3-35
7. EVA	3-43
8. LM Active Rendezvous	3-58

\*Used in both the LM & CSM.

### Section 3 - Detailed Timeline (Cont'd)

9. Undocked Orbital Activities	
LM Jettison	3-70
APS Burn to Depletion	3-70
SPS Burn No. 6	3-81
S065 Photography	3-81
Landmark Tracking	3-91
SPS Burn No. 7	3-104
S065 Photography	3-105,114,126
10. Entry Preparation	3-136
11. Deorbit	3-139

### Section 4 - Detailed Test Objective Activities

1. Introduction	4-1
2. DTO - Mission Activity Cross Reference	4-2
3. Launch Monitoring	4-13
4. CSM Transposition and Docking	4-14
5. LM/CSM Ejection from SLA	4-15
6. CSM PIPA Bias Test	4-16
7. Docked CSM IMU Alignment	4-17
8. Alignment Checks	4-18
9. SPS Burn No. 1	4-19
10. CSM Daylight Star Check	4-20
11. SPS Burn No. 2	4-21
12. SPS Burn No. 3	4-22
13. Tunnel Clearing - Three Crewmen in CM	4-24
14. EPS Activation and Checkout	4-25
15. ECS Activation	4-26
16. Tunnel Hardware Installation	4-27
17. Daytime AOT Star Visibility	4-28
18. Daytime AOT Star Occultation	4-29
19. LM Steerable Antenna Test	4-30
20. Communications Test - LM Activation	4-31
21. Landing Gear Deployment	4-33
22. Relay Tests	4-34
23. PLSS Communication Checks	4-36
24. LM PIPA Bias Test	4-38
25. Landing Radar Self-Test	4-39
26. AGS Initialization	4-40
27. AGS Calibration	4-41
28. Docked DPS Burn	4-42
29. Tunnel Clearing - Two Crewmen in LM	4-45
30. Sublimator Dryout	4-46
31. EVA	4-47
32. EVA Communications Test	4-49
33. LM LiOH Cartridge Removal	4-50
34. Rendezvous Radar Self-Test	4-51
35. LM/CSM Undocking and Inspection	4-52
36. LM AGS Attitude Control	4-55
37. LM IMU Alignments	4-56

Section 4 - Detailed Test Objectives (Cont'd)

38.	LM COAS Calibration Check	4-57
39.	EPS Preparation for a DPS Burn	4-58
40.	LM AGS Manual Translation	4-59
41.	Rendezvous Phasing Burn	4-60
42.	LM AOT Nighttime Star Observation - RR Steerable Antenna	4-62
43.	LM AOT Nighttime Star Observation - RR	4-63
44.	Rendezvous Insertion Burn	4-64
45.	Rendezvous Radar Tracking Test	4-65
46.	Rendezvous Communication Tests	4-66
47.	EPS Prestaging Check	4-67
48.	APS CDH Burn	4-68
49.	LM RCS Plume Effects on RR Tracking	4-69
50.	Rendezvous Data	4-70
51.	Post Rendezvous Inspection	4-71
52.	RR Corona Test	4-72
53.	LM PGNS Attitude Control	4-73
54.	LM PGNS Attitude Control	4-73
55.	LM Active Docking	4-75
56.	LM Jettison	4-76
57.	APS Burn to Depletion	4-77
58.	S065 Photography	4-78
59.	CSM Orbital Navigation	4-82
60.	Crew Monitoring	4-83

Section 5 - Communications Plan

1.	Introduction	5-1
2.	Launch	5-2
3.	Insertion to LM Activation	5-2
4.	LM Activation and Checkout	5-2
5.	EVA	5-3
6.	Rendezvous	5-4
7.	LM Jettison	5-5
8.	Post LM Jettison	5-5
9.	LM DFI Schedule	5-6
10.	MSFN Station Capabilities	5-13

Section 6 - Consumable Analysis

(TO BE SUPPLIED)

## INTRODUCTION

This Flight Plan has been prepared by the Flight Planning Branch, Flight Crew Support Division, with technical support by TRW Systems.

This document schedules the AS504/CSM104/LM3 operations and crew activities to fulfill, when possible, the test objectives defined in the Mission Requirements, D Type Mission, LM Evaluation and Combined Operations, Rev. 1, Change A.

The trajectory parameters used in this Flight Plan are for a February 20, 1969 launch, with a 72° launch azimuth and were supplied by Mission Planning and Analysis Division as defined by the Apollo Mission D Spacecraft Operational Trajectory, Rev. 1.

The Apollo 9 Flight Plan is under the configuration control of the Crew Procedures Control Board (CPCB). All proposed changes to this document that fall in the following categories should be submitted to the CPCB via a Crew Procedures Change Request:

1. Items that impose additional crew training or impact crew procedures.
2. Items that impact the accomplishment of detailed test objectives.
3. Items that result in a significant RCS or EPS budget change.
4. Items that result in moving major activities to a different activity day in the Flight Plan.
5. Items that require a change to the flight data file.

The Chief, Flight Planning Branch (FCSD) will determine what proposed changes fall in the above categories.

Mr. T. W. Holloway will act as co-ordinator for all proposed changes to the Apollo 9 Flight Plan.

This Flight Plan is not to be reproduced without the written approval of the Chief, Flight Crew Support Division.

Any requests for additional copies or changes to the distribution lists of this document must be made in writing to Mr. W. J. North, Chief, Flight Crew Support Division, MSC, Houston, Texas,

ABBREVIATIONS

ACCEL	Accelerometer	CDH	Constant Delta Altitude
ACN	Ascension	CDR	Commander
ACT	Activation	CDU	Control Data Unit
ACQ	Acquisition	CIRC	Circularization
AEA	Abort Electronics Assembly	CK	Check
AGS	Abort Guidance System	CM	Command Module
AB	Ampere Hours	CMC	Command Module Computer
ALIGN	Alignment	CONT	Continue
ALT	Altitude	CMD	Command
AMP or amp	Ampere	CMP	Command Module Pilot
AMPL	Amplifier	CNTL	Control
ANG	Antigua	CNTLS	Controls
Ant	Antenna	C.O.	Cut off
AOS	Acquisition of Signal	C/O	Check out
AOT	Alignment Optical Telescope	COAS	Crew Optical Alignment Sight
APS	Ascent Propulsion Subsystem	COMM	Communications
ARS	Atmosphere Revitalization	COMP	Computational
ASCT	Ascent	CONFIG	Configuration
ATT	Attitude	CONT	Continue
AUX	Auxiliary	CP	Control Point
AZ	Azimuth	CRO	Carnarvon, Australia
BAT	Battery	CRYO	Cryogenic
BDA	Bermuda	CSI	Coelliptic Sequence Initiation Maneuver
BIO	Bio-Medical Data on Voice Downlink	CSM	Command Service Module
BP	Barber Pole	C&WS	Caution and Warning System
BT	Burn Time	CYI	Grand Canary Island
BU	Backup	DAP	Digital Auto Pilot
B&W	Black & White	D/B	Deadband
BRKT	Bracket	DCA	Digital Command Assembly
CAL	Pt. Arguillo, California	DEDA	Data Entry and Display Assembly
CAL ✕	Calibration Angle	DEG	Degrees
CAM	Camera	DEPL	Depletion
CB	Circuit Breaker	DET	Determination or Digital Event Timer
		DIFF	Difference

ABBREVIATIONS (Cont'd)

DK	Docked	GBM	Grand Bahama
DOI	Descent Orbit Insertion	GDC	Gyro Display Coupler
DPS	Descent Propulsion Subsystem	GDS	Goldstone, California
DSE	Data Storage Equipment	GET	Ground Elapsed Time
DSKY	Display and Key Board	GETI	Ground Elapsed Time of Ignition
DTO	Detailed Test Objective	GLY	Glycol
DUA	Digital Uplink Assembly	GMT	Greenwich Mean Time
DWN	Down	G&N	Guidance and Navigation
E	Erasable	GNCS	Guidance Navigation Control System
ECS	Environmental Control System	GWM	Guam
EFH	Earth Far Horizon	GYM	Guaymas, Mexico
EI	Earth (atmosphere) Interface	HA	Apogee Altitude
ELDMK	Earth Landmark	HAW	Hawaii
EMS	Entry Monitor System	HBR	High Bit Rate (TLM)
ENH	Earth Near Horizon	HD	Highly Desirable
EPO	Earth Parking Orbit	HGA	High Gain Antenna
EPS	Electrical Power Subsystem	HI	High
EQUIP	Equipment	Hp	Perigee Altitude
EST	Eastern Standard Time	HSK	Honeysuckle (Canberra, Australia)
EVA	Extravehicular Activity	HTR	Heater
EVAP	Evaporator	HTV	USNS Huntsville
EVT	Extravehicular Transfer	ID	Identification
EXT	External	IGN	Ignition
f	F Stop	IMU	Inertial Measurement Unit
FC	Fuel Cell	INIT	Initialization
FDAI	Flight Director Attitude Indicator	INT	Intervalometer
FLT	Flight	IP	Initial Point
FM	Frequency Modulated	IU	Instrumentation Unit
FOV	Field of View	IVT	Intravehicular Transfer
fps	Feet per second	JETT	Jettison
FQ	Flight Qualification	kwh	Kilowatt Hour
FT or ft	Feet		
FTP	Full Throttle Position		



ABBREVIATIONS (Cont'd)

LAT	Latitude	MCC	Midcourse Correction
LBR	Low Bit Rate (TLM)	MCC-H	Mission Control Center - Houston
LBS or lbs	Pounds	or MCC	
LCG	Liquid Cooled Garment	MDC	Main Display Console
LDC	Landing	MEAS	Measurement
LDMK	Landmark	MER	USNS Mercury
LEB	Lower Equipment Bay	MET	Mission Event Timer
LFH	Lunar Far Horizon	M/I	Minimum Impulse
LGC	LM Guidance Computer	MLA or MIL	Merrit Island, Florida
LH	Left-hand	MIN	Minimum
L/H	Local Horizontal	MNVR	Maneuver
LHEB	Left-hand Equipment Bay	MON	Monitor
LHFEB	Left-hand Forward Equipment Bay	MSFN	Manned Space Flight Network
LiOH	Lithium Hydroxide	MTVC	Manual Thrust Vector Control
LLM	Lunar Landing Mission	NAV	Navigation
LLOS	Landmark Line of Sight	NCC	Corrective Combination Maneuver
LM	Lunar Module	nm	Nautical Miles
LMP	Lunar Module Pilot	NOM	Nominal
LNH	Lunar Near Horizon	NSR	Nominal Slow Rate
LOI	Lunar Orbit Insertion	NXX	Noun XX
LONG	Longitude	OBS	Observation
LOS	Loss of Signal	O/F	Oxidizer to Fuel
LPO	Lunar Parking Orbit	OPER	Operate
LR	Landing Radar	ORB	Orbital
LT	Light	ORDEAL	Orbit Rate Display Earth and Lunar
LTC	Lighting	ORIENT	Orientation
LV	Launch Vehicle	OVHD	Overhead
L/V	Local Vertical	P	Pitch
LVPD	Launch Vehicle Pressure Display	PAD	Voice Update
M	Mandatory	PCM	Pulse Code Modulation
MAD	Madrid, Spain	PC	Pericyynthion
MAN	Manual	PGA	Pressure Garment Assembly
MAX	Maximum		
MAX Q	Maximum Dynamic Pressure		

ABBREVIATIONS (Cont'd)

PGNCS	Primary Guidance Navigation Control Section	RT	Real Time
PIPA	Pulse Integrating Pendulous Accelerometer	RTC	Real-Time Command
PM	Phase Modulated	Rxx	Routine XX
POL	Polarity or Polarizing	S	Shaft
PRE	Pretoria, South Africa	SA	Shaft Angle
PREF	Preferred	S/C	Spacecraft
PREP	Preparation	SCE	Signal Conditioning Equipment
PRESS	Pressure	SCS	Stabilization Control System
PRIM	Primary	SCT	Scanning Telescope
PT	Point	SEC	Secondary
PRN	Pseudo-Random Noise	SECO	S-IVB Engine Cut-off
PROP	Proportional	SEP	Separate
PU	Propellant Utilization	SEQ	Sequence
PUGS	Propellant Utilization and Gaging System	SLA	Service Module LM Adapter
PTC	Passive Thermal Control	SLOS	Star Line-of-Sight
PWR	Power	SM	Service Module
Pxx	Program XX	SPOT	Spot Meter
Qty	Quantity	SPS	Service Propulsion System
R	Roll	SR	Sunrise
R&B	Red & Blue	SRX	S-Band Receiver Mode No. X
RAD	Radiator	SS	Sunset
RCDR	Recorder	STX	S-Band Transmit Mode No. X
RCS	Reaction Control System	STBY	Standby
RCU	Remote Control Unit	Sw	Switch
RCV	Receiver	SXT	Sextant
RED	USNS Redstone	SYNC	Synchronization
REFSMMAT	Reference Stable Member Matrix	T	Trunnion
REG	Regulator	T	Time of Ephemeris Update
REQD	Required	EPHEM	
RH	Right-hand	TA	Trunnion Angle
RNDZ	Rendezvous	TAN	Tananarive, Madagascar
RR	Rendezvous Radar	TCA	Time of Closest Approach
RSI	Roll Stability Indicator	TBD	To Be Determined

ABBREVIATIONS (Cont'd)

TEC	Trans Earth Coast		
TEI	Transearth Insertion		
TEMP	Temperature		
TERM	Terminate		
TEX	Corpus Christi, Texas		
T&D	Transposition and Docking		
TGT	Target		
TIG	Time of Ignition		
TLC	Trans Lunar Coast		
TLI	Translunar Insertion		
TLM	Telemetry		
TPF	Terminal Phase Final		
TPI	Terminal Phase Initiation		
TPM	Terminal Phase Midcourse		
T/R	Transmitter/Receiver		
TRANS	Translation		
TV	Television		
TVC	Thrust Vector Control		
TWR	Tower		
UMB	Umbilical		
UNDK	Undock		
US	United States Pass		
VAN	USNS Vanguard		
VHF	Very High Frequency		
VLV	Valve		
Vxx	Verb xx		
W/O	Without		
WRT	With Respect to		
XFER	Transfer		
XMIT	Transmit or Transmitter		
XPONDER	Transponder		
		Y	Yaw
		$\Delta V$	Velocity Change (Differential)
		$\Delta VC$	Velocity Change at Engine Cutoff
		$\Delta R$	Position Change (Differential)
		8-balls	Flight Director Attitude Indicator (FDAI)
		LBS or lbs	Pounds

SECTION 1

SECTION 1 - GENERAL

## FLIGHT PLAN DESCRIPTION

### DAY 1

#### Launch

Day 1 begins with launch at 11:00 A.M. EST (1600 GMT) from Pad 39A with a launch azimuth of 72°. Insertion into a 103-nm circular orbit occurs at 10 minutes, 49 seconds after lift-off. At insertion, the CSM/LM/S-IVB combination will go into orbit rate with the S/C in heads down attitude.

#### CSM/S-IVB Orbital Operation

Immediately after insertion, the crew begins a series of CSM S-IVB orbital operations. This activity is to configure the CSM for orbital operations, prepare for transposition, docking and ejection and to evaluate the operations required to verify that the CSM and S-IVB would be ready for TLI on a lunar mission. The actual TLI burn will not be performed on this mission. The GO/NO GO for orbit is given at Carnarvon on the first pass. Following sunrise, the pre-TLI demonstration is concluded and the COAS and ORDEAL box are mounted.

#### Transposition, Docking and LM Ejection

GO/NO GO for T&D is given at 2:30 GET during the second pass over Carnarvon. At this time the S-IVB IU is enabled by ground command. At 02:34 GET, the S-IVB goes to inertial attitude hold for TD&E. The CSM separates from the LM/S-IVB after second sunrise and performs a visual inspection of the LM/S-IVB while formation flying. Docking occurs at 03:00 GET. LM pressurization begins immediately after docking. To pressurize the tunnel and LM, the three 1-pound repress bottles and the surge tank will be used. The 1-pound bottles are discharged until empty, and the surge tank is dumped to 500 psia. The surge tank is then recharged and the process repeated until tunnel and CM cabin pressures are equal. The tunnel bleed valve is left open to allow CM O<sub>2</sub> to flow continuously into the tunnel and LM. A state vector update is uplinked over the U.S. at 03:15 GET. As soon as the tunnel and LM pressure have been verified, the tunnel is configured for ejection. The GO/NO GO for ejection is given over Carnarvon at 04:00 GET. At third sunrise, the CSM/LM is ejected from the SLA.

#### Evasive Maneuver and S-IVB Restarts

Immediately following ejection, the SCS does a 3-second, 4-jet, -X RCS translation. At burn attitude, the CSM is 50° pitched down from the S-IVB +X axis. This evasive maneuver is performed to get the CSM/LM at least 500 feet away from the S-IVB when the first S-IVB restart occurs. The GO/NO GO for the S-IVB restart is given at Hawaii at 04:25 GET. The S-IVB returns to local horizontal attitude at 04:25 GET, and the first S-IVB restart occurs at 04:45:41 GET. The second S-IVB restart is at 06:07 GET. S-IVB LOX and LH<sub>2</sub> dumping is completed by 06:42 GET.

### SPS Burn No. 1

Over Ascension at 05.00 GET the CSM, is sent a target load and a maneuver pad for the first SPS burn. The preferred IMU orientation for SPS No. 1 is calculated onboard, and the IMU is realigned to that orientation during the fourth night pass. The first SPS burn occurs at 06:01:40 GET over Hawaii. Burn time is 5.0 seconds and the  $\Delta V$  is 36.8 fps. No ullage is required. The burn is posigrade, and apogee is raised to 131 nm.

### Daylight Star Check and SXT Calibration

Over Texas at 06:20 GET, the CSM receives an update of the attitude required for the daylight star check. The daylight star check begins 15 minutes prior to the fifth sunrise and runs until 10 minutes after sunrise. This star identification exercise is done to determine if the optics are degraded by the light reflected from the surfaces of the LM. During the next night pass, a sextant calibration is performed using the Midcourse Navigation program. This calibration is done to determine any trunnion bias angle between the sextant lines of sight.

### Rest

Rest period begins at 9:00 GET (8:00 P.M. EST) and lasts 9 1/2 hours.

## DAY 2

Day 2 begins at 18:30 GET (5:30 A.M. EST).

### SPS Burn No. 2

An IMU orientation determination is done during the first night pass of the day. A state vector, a target load and maneuver pad for the second SPS burn are given the CSM over the Eastern Test Range at 20:40 GET. The preferred IMU orientation is calculated onboard, and the following night pass the IMU is realigned to the preferred orientation. SPS Burn No. 2 occurs at 22:12:00 GET over the Cape. Burn time is 111.1 seconds and the  $\Delta V$  is 850.1 fps. No ullage is required. The burn is out-of-plane and posigrade and raises apogee to 192 nm. During this burn the DAP stability test is run with 40% amplitude stroking.

### SPS Burn No. 3

Over the U.S. at 23:55 GET the CSM receives a state vector, target load and a maneuver pad for the third SPS Burn. The preferred IMU orientation is calculated onboard, and the IMU is realigned during the next night pass. SPS Burn No. 3 occurs at 25:18:30 GET over the Cape. Burn time is 279.4 seconds and the  $\Delta V$  is 2549.1 fps. No ullage is required. The burn is targeted mostly out-of-plane, and raises apogee to 271 nm. The DAP stability test is run again, this time with full amplitude stroking. Manual thrust vector control is used for the last 45 seconds of the burn.

### SPS Burn No. 4

State vector, target load and maneuver pad for the fourth SPS burn are given to the CSM over Texas at 26:50 GET. The preferred IMU orientation is calculated onboard, and the IMU is realigned during the next night pass. SPS Burn No. 4 occurs at 28:28:20 GET over Texas. Burn time is 28.0 seconds and  $\Delta V$  is 300.0 fps. Four-jet, 18-second ullage used. Targeting for the burn is out-of-plane. The orbit remains 271 nm by 115 nm.

### Rest

Rest period begins at 30:00 GET (5:00 P.M. EST) and lasts for 9 1/2 hours.

### DAY 3

Day 3 begins at 39:30 GET (2:30 A.M. EST). If required, tunnel and LM pressurization begins immediately. The surge tank and 1-lb bottles are used in the same manner as at T&D. State vector and desired IMU orientation for the Docked DPS Burn are uplinked to the CSM over the Huntsville at 41:05 GET.

#### IVT to LM & LM Activation

All crewmen don their PGA's. IVT GO/NO GO decision is at the Canaries at 41:55 GET. After clearing the tunnel hardware, the LMP transfers to the LM. The LMP activates the LM EPS, ECS, COMM, and INST systems.

During the first night pass after the LMP's IVT, the CMP performs P51, IMU Orientation Determination, with the CSM approximately out-of-plane. If time is available, P52, IMU Realign, is performed aligning the CSM platform to the Docked DPS Burn REFSMMAT.

The CDR transfers to the LM at 43:05. When the CDR completes his transfer, the tunnel hardware installation begins.

#### LM Systems Evaluation

A series of systems tests are performed to verify the operation of and gather data on the LM systems and system interactions. A daylight AOT star visibility check is performed at 43:55 GET. The S-Band steerable antenna check occurs over Carnarvon at 44:03.

The primary and secondary EVA COMM Modes are checked with the LMP connected to the PLSS COMM starting at 45:30. During the MILA pass at 46:27 GET, the TV COMM Mode is verified using the TV inside the LM for the entire MILA pass. Interior shots of the LM are made with wide angle lens.

#### Docked LM IMU Alignment

The procedure for aligning the LM platform does not require star sightings, thus saves RCS propellant. It takes advantage of a known CSM inertial attitude and known CSM/LM geometry to coarse align the LM IMU to the inertial frame. The LM platform is coarse aligned by 47:38 and the CSM and LM gimbal angles are voiced to MCC. MCC calculates the fine align torquing angles.

After RCS pressurization and cold fire check, the LM DAP is set and the DPS gimbal drive is checked. While driving the gimbals, the DPS throttle check is performed. The RCS engines are then hot fired.

At 48:10 GET over Bermuda, the MCC updates the LM and CSM state vectors to the CSM and the LM state vector to the LM. The LM MNVR PAD is voiced to the crew for the Docked DPS Burn. REFSMMAT is uplinked to the LGC.



The fine align torquing angles are voiced to the crew, the gyros are torqued via the DSKY, and the REFSMMAT Flag is set.

The CSM & LM REFSMMATS are identical for the Docked DPS Burn. The REFSMMAT gives zero LM FDAI roll, pitch, and yaw angles at the burn attitude (ou-of-plane). CSM FDAI angles at the burn attitude are 300° roll, 180° pitch, and 0° yaw. With the platform aligned, the crew initializes the AGS. AGS zero time (or K-factor) is 40:00.

#### Landing & Rendezvous Radar Self Tests

At 48:16 GET the LR is self-tested in both the descent and hover positions. Since the RR was unstowed immediately prior to the Daylight AOT Star Observation, the standard RR self-test is performed.

#### Docked DPS Burn

The DPS is pressurized at 48:40. Beginning at sunset at 48:40, the CMP realigns the CSM platform the REFSMMAT. Again the CSM & LM gimbal angles are obtained for LM platform realignment. The gimbal angles are voiced to MCC. The crew torques the gyros after receiving the torquing angles at 49:10 GET. AGS update and alignment follows the LM IMU realignment.

The CSM trims the CSM/LM to the Docked DPS burn attitude while the CDR and LMP monitor the maneuver. The CMP targets P30, External ΔV and enters P40, SPS Thrust. P40 is used to monitor the LM DPS Burn. In the LM, the External ΔV program, P30, and the AGS External ΔV routine are targeted for the Docked DPS burn. The DPS Thrust Program, P40, is entered and the AGS is used in the follow-up mode. The LM assumes attitude control at TIG -6 min. The manual throttle profile is described in Section 4, DOCKED DPS BURN, page 4-42. Docked DPS Burn occurs over Texas at 49:42:00 GET. The throttle-down from fixed-throttle-point occurs on ΔV at 124 fps. The engine is manually shut down 3 sec before automatic engine shutdown. Total Burn time is 367 seconds.

After the burn the Landing Radar self test and AGS calibration are performed.

#### Sublimator Dry-Out

When the tunnel is clear, the CDR transfers to the CM. The LMP then connects to the transfer umbilical. He remains in the LM until the sublimator is dry. The LM is powered down leaving on only the necessary heaters on the translunar bus. Power is switched to the CM at 51:00 GET.

#### SPS Burn No. 5

MCC updates the CSM state vector, a target load, and voices up a maneuver pad over Texas at 52:50 GET. The preferred IMU orientation is calculated onboard, and the IMU is realigned during the next night pass.

SPS Burn No, 5 occurs at 54:26:16 GET over Texas. Burn time is 41.4 seconds and  $\Delta V$  is 551.5 fps, <sup>4</sup> jet, 20 second ullage is used. The burn is targeted to circularize the orbit at 133 nm. Following the fifth SPS burn the crew doffs their PGA's.

Rest

Rest period begins at 57:00 GET (8:00 P.M. EST) and is 9 hours and 50 minutes in length.

#### DAY 4

Day 4 begins at  $\approx$  67:00 GET (6:00 A.M. EST); tunnel and LM pressurization begin immediately, if required.

#### IVT to LM

The crewmen don their PGA's and the tunnel is cleared by 69:22 GET. The LMP then transfers through the tunnel into the LM. CSM IMU orientation is determined during the next night pass. MCC uplinks the CSM state vector and desired orientation over Honeysuckle at 69:52 GET. The LMP activates the LM EPS, ECS, COMM, and INST. systems. The CDR transfers to the LM and connects to the LM ECS. The tunnel hardware is installed and the LM hatch is closed at 70:25 GET.

#### Attitude Control for EVA

The GNCS is used for the attitude control during EVA. The CMP realigns the CSM platform to the uplinked preferred orientation during the night pass starting at 71:00 GET. After the IMU is realigned, the CSM FDAI reads zero degrees roll, pitch, and yaw at the desired EVA attitude.

The attitude is determined by positioning the CSM -Z axis toward the sun, with the +X axis pointing south, then pitching the CSM 15° down and rolling left 80°. This attitude is held within the maximum deadband. The QUAD A & B SM RCS thrusters are disabled to avoid RCS jet impingement on the LMP during EVA.

#### Preparation for EVA

After the tunnel hardware installation, standard ECS, EPS and COMM checks are performed. The crew then prepare for EVA. All EVA prep procedures are described in the EVA Procedure Document.

Before the LMP dons the PLSS and OPS, the CDR and LMP reverse stations. The CDR holds the PLSS/OPS during the donning preparation. Over Honeysuckle Creek and the Mercury, the PLSS communication checks are performed. See the Communications Plan, Section 5 for details of the EVA comm.

All three crewmen don their helmets and gloves and verify the spacecraft cabins are prepared for depress. The LMP and CDR verify the pressure integrity of their PGA's and then depress the LM. While the LM depresses, the CMP checks the pressure integrity of his PGA. When the LM is fully depressurized, the LM hatch is opened and the LMP verifies proper suit cooling. The CSM is then depressurized and the CM side hatch opened.

#### EVA

Two sequence cameras record the EVA. One is attached to the inside of the CSM hatch. When the CMP opens the hatch, the camera "looks" down the transfer path. The other sequence camera is attached to the LM handrail. The LMP egresses the LM at 73:07 and attaches a sequence camera to the LM handrail.

Both cameras are operated by remote control by the CMP and the CDR at desired times during the EVA. After installing the camera, the LMP dons the "golden slippers" and rests.

Using the nominal transfer path, the LMP transfers to and partially ingresses the CSM, demonstrating extravehicular transfer. The transfer is timed and should require less than 15 minutes. During the EVA the CDR feeds out and keeps taut the EVA tether.

While at the CSM, the LMP retrieves thermal samples. After handing the samples to the CMP and resting, the LMP transfers back to the LM. The LMP dons the "golden slippers", rests, then passes the sequence camera to the CDR. Thermal samples on the LM are retrieved and handed to the CDR for stowage.

During the night pass and the remainder of the EVA, the LMP is restrained to the LM porch with tethers and "golden slippers". Exterior lighting is evaluated for illumination of the transfer path.

During the next daylight pass, the LMP photographs the LM and CSM. While both spacecraft are over Goldstone and MILA, the LMP will use the TV camera to photograph the exterior of the CSM and LM using the wide angle lens. At 75:23 GET the LMP ingresses the LM and the CDR closes the LM FWD hatch.

With the LM overhead hatch dump valve in DUMP, LM oxygen repressurizes the tunnel at the same time the LM is repressurized. CSM repressurization occurs immediately after LM repress. When the LM and CM pressures are 3.0 psia, the CSM pressure equalization valve is opened and LM O<sub>2</sub> pressurizes both spacecraft to 5.0 psia. Systems are then configured for post-EVA operations.

#### PLSS Recharge

The PLSS oxygen and water are recharged to 90% and the battery and LiOH cartridge are replaced. PLSS recharge is completed by 76:20 GET. The primary LiOH cartridge is then replaced.

#### Sublimator Dry-Out

Sublimator dry-out is accomplished in the same manner as Day 3. During the dry-out, the LMP is connected to the CSM transfer umbilical.

#### Rest Period

Rest Period begins at 79:00 GET (6:00 P.M. EST) and lasts approximately 7 1/2 hours.

## DAY 5

Day 5 begins at 86:30 GET (1:30 A.M. EST). Tunnel and LM pressurization begin immediately, if required.

### IVT to LM

The CSM IMU orientation is determined during the first night pass of the day. The crew then don their PGA's and clear the tunnel. At 89:00 GET, the LMP transfers through the tunnel to the LM.

Over the Mercury at 89:03, the MCC uplink the CSM and LM state vectors and the desired orientation for rendezvous to the CMC and voices the CSM DAP load. The CSM preferred orientation for the rendezvous is that of a nominal align for the time of alignment equal to TIG of TPI.

The CDR transfers to the LM after the LMP activates the LM. The Rendezvous Day LM checkout procedures were designed to simulate the lunar mission docked pre-DOI checkout as closely as possible. The DPS and RCS were pressurized on Day 3 thus cannot be done on Day 5. The criteria, however, was that all checks made where those that, if the checks failed, the lunar mission would be aborted.

### Preparation for Undocking

The CSM realigns to the preferred option at 90:25 GET. After the CSM is aligned, the LM platform is coarse aligned as described on Day 3 and the gimbal angles are voiced to MCC over the Mercury at 90:42 GET. The MCC also uplinks the LM and CSM state vectors and REFSMMAT to the LGC at 91:07. The LM rendezvous REFSMMAT is that of a nominal alignment at TIG of TPI.

Over the U.S. at 91:10 GET, MCC voices the gyro torquing angles to the LM. The LM and CSM platforms are oriented so that the stable member axes are related as follows:

$$\bar{X}_{LM} = -\bar{Z}_{CM}$$

$$\bar{Y}_{LM} = \bar{Y}_{CM}$$

$$\bar{Z}_{LM} = \bar{X}_{CM}$$

The LM Rendezvous Radar is self-tested at 91:58 GET. Over Honeysuckle at 92:02 the maneuver pads for the phasing burn are voiced to the crew. The CSM then trims to the undocking attitude and at 92:39 GET the CSM extends the probe. The vehicles are then undocked.

### SM RCS Separation and DPS Phasing

The detailed rendezvous procedures are documented in the CSM Rendezvous Procedures Document and the LM Rendezvous Procedures Document. After undocking, the LM rotates for the CMP's inspection of the LM landing gear. The CSM then targets for the separation burn. Using the RCS thrust Program, P41, the CSM separates with a radially down burn of 5 fps  $\Delta V$ .

As the separation distance increases, the LM RR is turned on, locked onto the CSM transponder, checked and positioned for the IMU alignment. The LM platform is aligned to REFSMMAT using the AOT for the first time. The CSM also realigns to REFSMMAT. The RR is again turned on and locked on the CSM. At 93:50:03.6 GET over the Mercury the LM performs phasing with a DPS burn to achieve 85 fps  $\Delta V$ . Phasing is an AGS controlled burn; the PGNCS residuals are nulled after the burn.

### Insertion

When the residuals are nulled, the P20, Rendezvous Navigation program, is entered and, for the first time, RR data is used to update the LM state vector. The CMP also begins taking sextant marks to update the CMC's LM state vector.

By 94:10 the CSM and LM have a TPI<sub>0</sub> solution; these are reported to the MCC. After passing the maximum separation distance in the "football", the LM RR again locks on. The LM and CSM again take marks.

At 94:50 GET the CSM and LM both again have TPI<sub>0</sub> solutions. If the spacecraft are GO for the nominal rendezvous, they both begin to realign their platforms to REFSMMAT. If the decision is NO GO, TPI<sub>0</sub> is executed by the LM if it is capable and by the CSM if the LM is not capable of performing the burn.

Upon completing the alignment the RR locks onto the CSM transponder and the crew monitor the closest approach of the two vehicles. At 95:41:48.1 over GYM the LM executes a DPS posigrade burn with a  $\Delta V$  of 39.9 fps to insert the LM into the coelliptic rendezvous sequence.

The CSM is targeted with the same burn one minute later. If during the burn it is decided to maintain the relative motion of the "football" the CSM can perform such a burn.

### CSI, Staging

After the insertion burn, the LM again locks onto the CSM. Both spacecraft begin taking marks updating the LM state vector in each computer. About 8 minutes prior to CSI, the LM crew configure the LM for staging. At 96:22:00 GET, over Tananarive the LM executes CSI using 4 RCS jets and the APS interconnect to burn 37.8 fps retrograde. Immediately after the initiation of thrust the staging pyros are fired and the LM is staged.

For each of the LM rendezvous burns, the CSM targets for a "mirror image" burn. If for some reason the LM cannot perform the burn, the CSM is prepared to burn one minute after the nominal burn time.

### CDH

During the rendezvous, the crew will eat as time permits. After CSI, the RR reacquires the CSM and marks are taken. The CMP also takes marks using the sextant. The CDR maintains the LM +Z axis pointed towards the CSM line-of-sight  $\pm 30^\circ$ . Over the Redstone at 97:06:22.6 GET, the LM executes CDH using the APS for a 2.9 second burn. CDH is retrograde and  $\Delta V = 37.9$  fps. The LM is then coelliptic with the CSM.

### TPI to Docking

For TPI both spacecraft take marks and calculate onboard solutions. The LM also updates the AGS LM state vector with RR data approximately every three minutes. The CDR maintains an attitude where the RR shaft and trunnion angles are zero for the AGS RR updates. When the final LM TPI solution (P34) is obtained the LM maneuvers to point the LM +Z at the CSM. At 98:00:15 GET over Tananarive the LM executes a line-of-sight burn of 21.8 fps.

Immediately after TPI, the LM pitches to point +Z at the CSM. Both spacecraft take marks and target for each midcourse. The first midcourse is at TPI + 10 minutes, the second at TPI + 22 minutes. After MCC<sub>2</sub>, the LM maintains line-of-sight, nulls line-of-sight rates, and performs braking. The braking schedule is as follows:

30 fps - 6000 ft  
20 fps - 3000 ft  
10 fps - 1500 ft  
Rendezvous, 0 fps - 100 ft

While formation flying with the CSM, the LM performs attitude control tests as described in Section 4. The CMP photographs the LM and the LMP photographs the CSM. At 99:05 the LM and CSM begin the maneuver for docking and the LM translates to capture latch. Upon capture the CMP retracts the probe and the LM docks with the CSM.

### APS Burn to Depletion

The night pass after docking is used to perform a docked AOT P52 realign to REFSMMAT. To prepare for the APS burn to depletion the crew takes the probe and drogue out of the tunnel after the tunnel is pressurized and stows the probe and drogue on the LM floor. The PGNCs is targeted for the APS burn. At 100:45 the CDR transfers to CSM. The LMP prepares the LM systems for jettison and the CSM maneuvers to jettison attitude.

Just before transferring to the CSM, the LMP opens the APS interconnect and leaves the LGC in POO. At 101:05 the LMP closes the LM hatch.

To minimize helium ingestion into the RCS the crew waits until 101:33 to jettison the LM. Immediately after LM jettison the CSM maneuvers to behind the LM and performs a 3 fps RCS burn to separate the CSM from the LM. Over Texas MCC again sends commands to the LM and at 102:00 the APS ignites and burns to depletion.

REST

Rest period begins at 104:15 GET (7:15 P.M. EST) and is 9 1/2 hours long.



## DAY 6

Day 6 begins at 113:30 GET (4:30 A.M. EST).

### SPS Burn No. 6

The S/C is powered up and the IMU orientation is determined during the fourth night pass of the day. State vector, target load and maneuver pad for the sixth SPS burn are sent to the CSM over the Vanguard at 119:40 GET. The preferred IMU orientation is calculated onboard, and the IMU is realigned during the next night pass. Ignition for SPS Burn No. 6 is at 122.01 GET over Carnarvon. Burn time is 2.5 seconds and  $\Delta V$  is 66.2 fps. Two-jet, 18-second ullage is used. The burn is retrograde and lowers perigee to 95 nm.

### S065 Photography

During the night pass following the SPS burn, the s065 camera equipment is unstowed and mounted in the hatch window. This equipment consists of four electric Hassleblad cameras which are mounted together and are triggered simultaneously. Service Module RCS jet B-3 must be disabled to preclude the spraying of exhaust gas into the camera's field of view during a pass. The spacecraft is then maneuvered in-plane with the hatch window parallel to local horizontal and orbital rate is established. During each pass the cameras are triggered at a fixed time interval updated by MCC. Two S065 passes are made during the sixth day. The first pass occurs at the end of Rev 78 over the southwestern U.S., and the second is during the Rev 79 over Mexico. Following these passes the equipment is removed from the window and re-stowed. RCS jet B-3 is re-enabled.

### Rest

Rest period begins at 129:00 GET (8:00 P.M. EST) and is 9 1/2 hours long.

## DAY 7

Day 7 begins at 138:30 GET (5:30 A.M. EST).

### Undocked Landmark Tracking

The spacecraft is powered up and the IMU orientation is determined during the second night pass of the day. State vector and nominal IMU orientation are uplinked to the spacecraft over the U.S. at 141:35 GET. The IMU is realigned to the nominal orientation during the next night pass. The update for the first set of landmarks is passed over Honeysuckle at 142:40 GET, and the first landmark tracking exercise is conducted over the U.S. and South Atlantic from 143:00 to 143:40 GET during Rev 91. The next three day passes are used for additional landmark tracking. The night pass between each rev of landmark tracking is used to realign the IMU. The yaw/roll method is used during all landmark tracking.

### Rest

Rest period begins at 152:00 GET (7:00 P.M. EST) and is 10 hours in length.

## DAY 8

Day 8 begins at 162:00 GET (5:00 A.M. EST).

### SPS Burn No. 7

The spacecraft is powered up and the IMU orientation is determined during the fourth night pass of the day. State vector, target load and maneuver pad for the seventh SPS burn are passed to the spacecraft over the U.S. at 168:10 GET. The preferred IMU orientation is calculated onboard and the IMU is realigned during the next night pass. Ignition for SPS Burn No. 7 is at 169:49 GET over the Cape. Burn time is 6.8 seconds and  $\Delta V$  is 174.0 fps. Two-jet, 18-second ullage is used. The burn is posigrade and raises apogee to 210 nm.

### S065 Photography

Following the seventh SPS burn, two more passes of S065 photography are made. The procedure followed is the same as during Day 6. The areas photographed are again the southwest U.S. on Rev 108, and Mexico on Rev 109. In addition, a pass is made over Brazil early in Rev 110.

### Rest

Rest period begins at 175:00 GET (6:00 P.M. EST) and is 9 1/2 hours in length.

#### DAY 9

Day 9 begins at 184:30 GET (3:30 A.M. EST).

#### S065 Photography

The spacecraft is powered up and a nominal IMU alignment for S065 is passed to the spacecraft over the Eastern Test Range at 187:30 GET. The IMU is oriented and realigned during the next night pass. S065 photography is done during Revs 120 and 121. The first pass is over northern Mexico and the southeastern U.S. Early in Rev 121 a pass over southwest and southern Africa is made. At the end of Rev 121 is the final pass, over the southern U.S.

#### Rest

Rest period begins at 198:00 GET (5:00 P.M. EST) and is 9 1/2 hours long.

#### DAY 10

Day 10 begins at 207:30 GET (2:30 A.M. EST).

#### S065 Photography

The spacecraft is powered up and a nominal IMU alignment is given the spacecraft over the U.S. at 211:30 GET. The IMU is oriented and realigned during the following night pass. S065 photography is performed during Revs 135 and 136. The same general areas in Mexico, the U.S. and Africa which were used on Day 9 are once again photographed.

#### Rest

Rest period begins at 222:00 GET (5:00 P.M. EST) and is 10 hours in length.

## DAY 11

Day 11 begins at 232:00 GET (3:00 A.M. EST).

### Entry Preparation

Initial entry preparation and stowage begins at 232:00 GET. The orientation of the IMU will be determined during the third night pass of the day. The pre-entry updates will be sent to the spacecraft over the U.S. at 235:15 GET. These updates will include a state vector, target load, desired IMU orientation, maneuver pad and entry pad. The next night pass, the IMU will be realigned to the preferred orientation. The preferred orientation will not be calculated onboard. Following realignment, entry preparations are completed.

### SPS Deorbit Burn

The spacecraft will maneuver to deorbit attitude 45 minutes prior to deorbit. Deorbit attitude is heads up, pitched down  $31.7^\circ$  below the horizon,  $180^\circ$  yaw. Ignition occurs at 238:11:47 GET over the Redstone. Burn time is 9.6 seconds and  $\Delta V$  is 253.5 fps. Four-jet, 15-second ullage is used. Perigee is lowered to 0 nm.

### Entry

Approximately 5 minutes after deorbit CM/SM separation occurs. A GNCS auto entry is flown. The CM passes through 400K feet at 238:30 GET and chutes are deployed 11 minutes later. Splashdown is at 238:47 GET (9:47 A.M. EST).

### FLIGHT PLAN NOTES

#### A. Crew

1. Crew designation is as follows:

<u>Designation</u>	<u>Couch position at lift-off and entry</u>	<u>Prime</u>	<u>Backup</u>
Commander (CDR)	Left	McDivitt	Conrad
Command Module Pilot (CMP)	Center	Scott	Gordon
Lunar Module Pilot (LMP)	Right	Schweikart	Bean

2. The mission is broken down into 11 activity days. Each day is one crew activity period and one rest period. Since crew activity periods vary in length according to mission phase, so do activity days. For this reason the activity days are not established on a 24-hour basis. All three crew members will sleep simultaneously. The CDR and CMP will sleep in the couches. Both the CDR and CMP will wear their COMM headsets and remain on alert duty.

3. The CMP will doff his helmet and gloves at approximately 00:15 GET. The CDR and LMP have the option to do so after the CRO orbital GO. All crewmen will doff their helmets and gloves after transposition, docking, and ejection.

4. The crew has the option to doff the pressure suits at the end of the first day's activity. If doffed, they will be donned for activities in the LM.

5. The crew will eat together when possible. One hour will be allocated for each eat period when possible. Other activities will be held to a minimum during the eat periods.

6. Two night passes are scheduled for IMU orientation determination, IMU realignment, and systems preparation prior to activities requiring the GNCS or PGNCS. If the IMU orientation is known but unacceptable, one full night pass is scheduled for realignment.

7. CSM spacecraft maneuver rates, unless required to support mission objectives or time critical events, will generally not exceed 0.5 deg/sec.

8. LM spacecraft maneuver rates, unless required to support mission objectives or time critical events, will generally not exceed 2.0 deg/sec.

B. Mission Control Center (MCC) Interface

1. During communications, the spacecraft will be referred to by name and the MCC will be referred to as "Houston".
2. General flight plan and consumables updates will be voiced to the crew at the start of each day's activity and will contain a schedule of that day's activities. Detailed updates to support each activity will be voiced to the crew as required throughout the day.
3. Negative reporting will be used by the flight crew in reporting the completion of each checklist. The checklist will not be read by the flight crew or MCC over air/ground during the conduct of the checklist unless specifically requested by the MCC during abnormal conditions.
4. All onboard gage readings except RCS quantity reported to MCC by the crew will be read directly from the spacecraft gage and not corrected by the appropriate factors. RCS quantity will be temperature corrected.

C. Spacecraft Systems

1. The spacecraft lift-off and powerdown switch positions will be published in the applicable AOH, VOL. II.
2. Periodic spacecraft systems monitoring is a continuing task and is not scheduled in the flight plan timeline.
3. Each CSM CO<sub>2</sub> Filter will be replaced approximately every 24 hours. The primary LM LiOH cartridge will be changed after the EVA on Day 4.
4. Fuel cell O<sub>2</sub> purges will be performed approximately every 12 hours. H<sub>2</sub> purges will be performed approximately every 48 hours.
5. Potable water chlorination will be scheduled approximately every 24 hours starting at Day 2.
6. Tunnel hardware will be replaced after every crew transfer between the CSM and LM. The only exception to this will be prior to LM jettison, when the probe and drogue will be stowed inside the LM.
7. The CM/LM ΔP VLV valve will be left in the "LM" position for periods when the LM is not manned, allowing CM O<sub>2</sub> to bleed into the LM. For docked manned activity, the valve is in the "LM/CM Tunnel" position, allowing for onboard reading of tunnel pressure. During rendezvous the valve is off.

D. Procedures

1. Crew procedures for the accomplishment of the system and mission operations called out in the flight plan may be found in the following documents:

- a. CSM Apollo Operations Handbook
- b. LM Apollo Operations Handbook
- c. Abort Summary Document
- d. EVA Procedures Document
- e. LM Rendezvous Procedures Document
- f. CSM Rendezvous Procedures Document
- g. Entry Summary Document
- h. Crew Checklists

2. Particular procedures for the accomplishment of the specific DTO tests are found in Section 4 of this document. A reference to the applicable test procedure is also shown by the test in the timeline, Section 3.

E. Crew Status Reports

During the mission, two crew status reports via air-to-ground communications will be made by the flight crew during each activity day. The first report will be given after the first meal of the day and will concern the sleep obtained during the previous sleep period. The second report will be given following the final meal of the day and will concern the radiation dose received during the previous 24 hours. The following information should be transmitted or logged as appropriate:

1. A daily report of each crewman's best estimate as to sleep quantity and quality.

2. A daily report of the integrated radiation dose each crewman receives.

3. An onboard record of water consumption, food not eaten, and exercise. No report is required.

4. Used fecal bags will be identified as to crewman and GET with the marker pens.

SECTION 2 - UPDATE PADS



INTRODUCTION

The following update pads are used for copying  
MSFN voice updates onboard the CSM and LM.

CSM BLOCK DATA

BLOCK DATA		
		AREA LAT LONG TIG $\Delta V_c$
		AREA LAT LONG TIG $\Delta V_c$
		AREA LAT LONG TIG $\Delta V_c$
		AREA LAT LONG TIG $\Delta V_c$
		AREA LAT LONG TIG $\Delta V_c$
REMARKS		

BLOCK DATA

AREA	XXX-XX	RECOVERY AREA FIRST 3 DIGITS - LANDING REVOLUTION LAST 2 DIGITS - RECOVERY AREA AND SUPPORT CAPABILITIES
LAT	+XX.X (DEG)	LATITUDE OF DESIRED LANDING AREA
LONG	+XXX.X (DEG)	LONGITUDE OF DESIRED LANDING AREA
TIG	XXX:XX:XX (HR:MIN:SEC)	DEORBIT IGNITION TIME FOR THE DESIRED LANDING AREA
$\Delta V_c$	XXX.X (fps)	$\Delta V$ SET INTO THE EMS $\Delta V$ COUNTER

CSM P27 UPDATE

P27 UPDATE						
	V		V		V	
INDEX		INDEX		INDEX		PURP
						01
						02
						03
						04
						05
						06
						07
						10
						11
						12
						13
						14
						15
						16
						17
						20
						21
						22
						23
						24
	:	:	:	:	:	T 34
						φ 43
						λ NAV CHECK
						H
+		+		+		
REMARKS						

P27 UPDATE

V	XX	TYPE OF COMMAND LOAD (70 - 71 - 72 - 73)
PURP		TYPE OF DATA TO BE RECEIVED (SUCH AS: NAV, LIFT-OFF TIME)
01	XX	INDEX NO. OF COMMAND WORDS IN LOAD (OCTAL)
02-24	XXXXX	COMMAND WORDS (OCTAL)
NAV CHECK		SPACECRAFT POSITION RELATIVE TO THE EARTH AT A GIVEN TIME
T	XXX:XX:XX (HR:MIN:SEC)	GET OF NAV CHECK
$\phi$	(DEG)	LATITUDE
$\lambda$	(DEG)	LONGITUDE
h	(nm)	ALTITUDE

CSM NAV CHECK

NAV CHECK			
+ 0 0	+ 0 0	HRS	N34
+ 0 0 0	+ 0 0 0	MIN	
+ 0	+ 0	SEC	
0	0	LAT (+N)	N34
		LONG (+E)	
+ 0	+ 0	ALT	
+ 0 0	+ 0 0	HRS	N34
+ 0 0 0	+ 0 0 0	MIN	
+ 0	+ 0	SEC	
0	0	LAT	N43
		LONG	
+ 0	+ 0	ALT	
+ 0 0	+ 0 0	HRS	N34
+ 0 0 0	+ 0 0 0	MIN	
+ 0	+ 0	SEC	
0	0	LAT	N43
		LONG	
+ 0	+ 0	ALT	
+ 0 0	+ 0 0	HRS	N34
+ 0 0 0	+ 0 0 0	MIN	
+ 0	+ 0	SEC	
0	0	LAT	N43
		LONG	
+ 0	+ 0	ALT	

NAV CHECK

SPACECRAFT POSITION DEFINED RELATIVE TO THE EARTH FOR  
A GIVEN TIME

HRS	XXX	}	GET WHEN NAV CHECK IS VALID
MIN	XX		
SEC	XX.XX		
LAT	±XX.XX (DEG)	LATITUDE	
LONG	±XXX.XX (DEG)	LONGITUDE	
ALT	XXX.X (nm)	ALTITUDE	

CSM MANUEVER UPDATE

MANEUVER UPDATE (P30)									
				PURPOSE					
+	0	0	.	+	0	0	.	HR TIG	33
+	0	0	0	+	0	0	0	MIN	
+	0	.	.	+	0	.	.	SEC	
.	.	.	.	.	.	.	.	$\Delta V X$	81
.	.	.	.	.	.	.	.	$\Delta V Y$	LOCAL
.	.	.	.	.	.	.	.	$\Delta V Z$	VERT
+	.	.	.	+	.	.	.	$\Delta V R$	42
+	.	.	.	+	.	.	.	$\Delta V C$	
								BT	
+	.	.	.	+	.	.	.	CSM. WT	47
0	0	.	.	0	0	.	.	PTRM	48
0	0	.	.	0	0	.	.	YTRM	
								SXTS	
								SFT	
								TRUN	
0	.	.	.	0	.	.	.	$\phi(+N)$ NAV	43
.	.	.	.	.	.	.	.	CHECK	
+	0	.	.	+	0	.	.	(TIG-30)	
.	.	.	.	.	.	.	.	h	
REMARKS    R _____ P _____ Y _____									
RESIDUALS _____ $\Delta V C$ _____									



MANEUVER UPDATE

PURPOSE		PURPOSE OF MANEUVER (SUCH AS: SPS NO. 1)
TIG		IGNITION TIME FOR THE MANEUVER _____
HR	XXX	
MIN	XX	
SEC	XX.XX	
$\Delta V_X$	$\pm XXXX.X$ (fps)	LOCAL VERTICAL COMPONENTS OF THE MANEUVER
$\Delta V_Y$	$\pm XXXX.X$ (fps)	
$\Delta V_Z$	$\pm XXXX.X$ (fps)	
$\Delta V_R$	XXXX.X (fps)	TOTAL $\Delta V$ REQUIRED FOR THE MANEUVER
$\Delta V_C$	XXXX.X (fps)	$\Delta V$ SET INTO THE EMS $\Delta V$ COUNTER
BT	X:XX.X (MIN:SEC)	DURATION OF THE MANEUVER
CSM.WT	XXXXX. (LBS)	PREMANEUVER WEIGHT OF THE SPACECRAFT
PTRM	$\pm X.XX$ (DEG)	SPS ENGINE PITCH GIMBAL TRIM
YTRM	$\pm X.XX$ (DEG)	SPS ENGINE YAW GIMBAL TRIM
SXTS	XX	OCTAL IDENTIFIER FOR SEXTANT STAR USED TO VERIFY SPACECRAFT ATTITUDE
SFT	XXX.XX (DEG)	SEXTANT SHAFT ANGLE TO ACQUIRE STAR

MANEUVER UPDATE (cont'd)

TRUN	XX.XXX (DEG)	SEXTANT TRUNNION ANGLE TO ACQUIRE STAR
NAV CHECK		SPACECRAFT POSITION RELATIVE TO THE EARTH AT TIG -30 MIN
$\phi$	$\pm$ XX.XX (DEG)	LATITUDE
$\lambda$	$\pm$ XXX.XX (DEG)	LONGITUDE
h	XXX.X (nm)	ALTITUDE
R		ROLL GIMBAL ANGLE AT TIG
P		PITCH GIMBAL ANGLE AT TIG
Y		YAW GIMBAL ANGLE AT TIG
RESIDUALS		$\Delta$ V COMPONENTS AND EMS COUNTER READING REMAINING AFTER THE MANEUVER

CSM ENTRY AND POSTBURN UPDATE











ENTRY UPDATE					
		-			AREA
					P300K
	0	.		0	LAT 61
		.			LONG
+		.	+		RTGO .05G
+		.	+		VIO .05G
		:			RET .05G
		:			RET .2G
		:			DRE 66
R	L	/	R	L	BANK AN
		:			RET RB
		:			RET BBO
		:			RETEBO
		:			RETDROG
		:			RET MAIN
		:			BBA(ΔV@90)CHART.
		:			DRE(@90) UPDATE
POSTBURN UPDATE					
+		.	+		RTGO .05G 63
+		.	+		VIO .05G
		:			RET .05G
		:			RET .2G 66
		:			DRE
R	L	/	R	L	BANK AN
		:			RETRB
		:			RET BBO
		:			RETEBO
		:			RETDROG
		:			RET MAIN

ENTRY UPDATE AND POSTBURN UPDATE

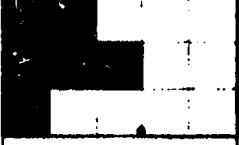
AREA	XXX-X	RECOVERY AREA FIRST 3 DIGITS - LANDING REVOLUTION LAST DIGIT - RECOVERY AREA AND SUPPORT CAPABILITIES
P300K	XXX (DEG)	PITCH ENTRY GIMBAL ANGLE AT 300K FT
LAT	±XX.XX (DEG)	LATITUDE OF LANDING TARGET POINT
LONG	±XXX.XX (DEG)	LONGITUDE OF LANDING TARGET POINT
RTGO .05G	XXXX.X (nm)	RANGE TO GO FROM .05G TO TARGET
VIO .05G	XXXXX. (fps)	INERTIAL VELOCITY AT .05G
RET .05G	XX:XX (MIN:SEC)	TIME FROM RETROFIRE TO .05G
RET .2G	XX:XX (MIN:SEC)	TIME FROM RETROFIRE TO .2G
DRE	±XXXXX. (nm)	DOWNRANGE ERROR AT .2G
BANK AN	XX/XX (DEG/DEG)	BACKUP BANK ANGLE FOR SCS ENTRY: ROLL RIGHT/ROLL LEFT
RETRB	XX:XX (MIN:SEC)	TIME FROM RETROFIRE TO REVERSE BACKUP BANK ANGLE
RETBBO	XX:XX (MIN:SEC)	TIME FROM RETROFIRE TO BEGINNING OF COMMUNICATIONS BLACKOUT
RETEBO	XX:XX (MIN:SEC)	TIME FROM RETROFIRE TO END OF COMMUNICATIONS BLACKOUT
RETDROG	XX:XX (MIN:SEC)	TIME FROM RETROFIRE TO DROGUE CHUTE DEPLOYMENT

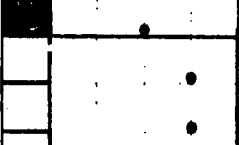
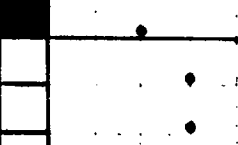
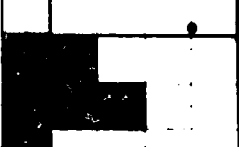
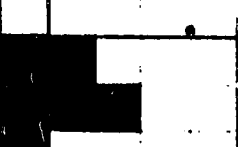
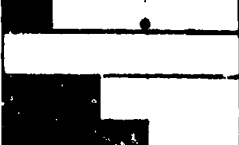
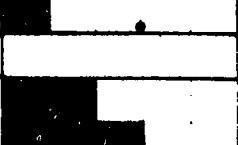
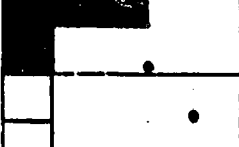
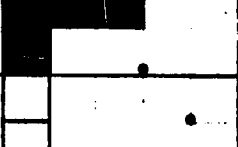

CSM STAR CHECK UPDATE

STAR CHECK UPDATE			
		HR MIN SEC	GET SR
		R P Y	FDAI
		HR MIN SEC	T ALIGN
		HR MIN SEC	GET SR
		R P Y	FDAI
		HR MIN SEC	T ALIGN
		HR MIN SEC	GET SR
		R P Y	FDAI
		HR MIN SEC	T ALIGN



CSM LANDMARK TRACKING UPDATE

LANDMARK TRACKING UPDATE						
			LANDMARK ID			
			HR	GET	ACQ	
			MIN			
			SEC			
			R		FDAI	
			P			
			Y			
			SFT			
			TRUN			
			LANDMARK ID			
			HR	GET	ACQ	
			MIN			
			SEC			
			R		FDAI	
			P			
			Y			
			SFT			
			TRUN			
			LANDMARK ID			
			HR	GET	ACQ	
			MIN			
			SEC			
			R		FDAI	
			P			
			Y			
			SFT			
			TRUN			



LANDMARK TRACKING UPDATE (CSM ORBITAL NAVIGATION, Pg 4-82)

LANDMARK ID -	XXX	LANDMARK IDENTIFICATION NUMBER
GET ACQ		TIME WHEN LANDMARK IS FIRST VISIBLE
HR	XXX	
MIN	XX	
SEC	XX.XX	
R	±XXX.X	} (DEG) GIMBAL ANGLES REQUIRED TO PLACE SPACECRAFT AT TRACKING ATTITUDE
P	±XXX.X	
Y	±XXX.X	
SFT	XXX.XX	} (DEG) SHAFT AND TRUNNION ANGLES TO PLACE LANDMARK IN OPTICS FIELD-OF-VIEW
TRUN	XX.XXX	

CSM S065 UPDATE

S065 UPDATE					
				SITE (OR AREA)	
•	•	R	FDAI		
•	•	P			
•	•	Y			
[REDACTED]	[REDACTED]	HR	GET START		
		MIN	(5 MIN PRIOR TO)		
		SEC	FIRST EXPOSURE)		
		HR	T ALIGN		
[REDACTED]	[REDACTED]	MIN	(IF REQ)		
		SEC			
		EXPOSURE INTER-SEC			
		NUMBER OF EXPOSURES			
ORB RATE		ORB RATE	ATTITUDE CONTROL		
INERTIAL		INERTIAL			
				SITE (OR AREA)	
•	•	R	FDAI		
•	•	P			
•	•	Y			
[REDACTED]	[REDACTED]	HR	GET START		
		MIN	(5 MIN PRIOR TO)		
		SEC	FIRST EXPOSURE)		
		HR	T ALIGN		
[REDACTED]	[REDACTED]	MIN	(IF REQ)		
		SEC			
		EXPOSURE INTER-SEC			
		NUMBER OF EXPOSURES			
ORB RATE		ORB RATE	ATTITUDE CONTROL		
INERTIAL		INERTIAL			

S065 UPDATE (S065 PHOTOGRAPHY, Pg 4-78)

SITE (OR AREA)		SITE NUMBER OR NAME OF AREA TO BE PHOTOGRAPHED
FDAI		FDAI ANGLES REQUIRED TO PLACE THE S/C AT PROPER ATTITUDE FOR THE PASS
R	XXX.XX(DEG)	
P	XXX.XX(DEG)	
Y	XXX.XX(DEG)	
GET START		TIME TO MANEUVER S/C TO PROPER ATTITUDE TO BEGIN PASS (5 MINUTES BEFORE THE FIRST EXPOSURE IS MADE)
HR	XXX	
MIN	XX	
SEC	XX	
T ALIGN		ALIGN TIME FOR NOMINAL IMU ORIENTA- TION PRIOR TO THE EXPERIMENT-IF REQUIRED
HR	XXX	
MIN	XX	
SEC	XX	
EXPOSURE INTERVAL	XX(SEC)	TIME INTERVAL BETWEEN EXPOSURES
NUMBER OF EXPOSURES	XXX	NUMBER OF EXPOSURES TO BE MADE OVER THE SITE OR AREA
ATTITUDE CONTROL		WHETHER THE PASS IS TO BE MADE IN ORBIT RATE (FOR LONG PASSES OVER LARGE AREAS) OR IN INERTIAL ATTITUDE HOLD (FOR SHORT PASSES OVER INDIVIDUAL SITES)

CSM & LM CONSUMABLES UPDATE

CONSUMABLES UPDATE				
				G.E.T.
				WPU A
				SM DAP RED
				SM SCS RED
				HYB DAP RED
				WPU B
				SM DAP RED
				SM SCS RED
				HYB DAP RED
				WPU C
				SM DAP RED
				SM SCS RED
				HYB DAP RED
				WPU D
				SM DAP RED
				SM SCS RED
				HYB DAP RED
				1bs O2
				1bs H2
				BAT A
				BAT B Amp-Hrs
				BAT C
				LM
				A % RCS
				B
				DESC 1bs O2
				DESC
				ASC Amp-Hrs

CONSUMABLES UPDATE

GET	XXX(HR)	TIME WHEN THE UPDATE IS VALID
WPU	XX(%)	PERCENTAGE OF USEABLE PROPELLANT..... REMAINING IN THE QUAD
SM DAP REDLINE	XX(%)	PERCENTAGE OF USEABLE QUAD PROPELLANT REQUIRED FOR A G&N CONTROLLED SM RCS DEORBIT
SM SCS REDLINE	XX(%)	PERCENTAGE OF USEABLE QUAD PRO- PELLANT REQUIRED FOR A SCS CONTROLLED SM RCS DEORBIT
HYBRID DAP REDLINE	XX(%)	PERCENTAGE OF USEABLE QUAD PRO- PELLANT REQUIRED FOR A G&N CONTROLLED HYBRID DEORBIT..
O2	XXX(LBS)	TOTAL AMOUNT OF O2 CRYOGENICS REMAINING
H2	XX (LBS)	TOTAL AMOUNT OF H2 CRYOGENICS REMAINING
BAT A,B&C	XX (Amp-Hrs)	NUMBER OF AMP-HRS REMAINING IN ENTRY & POSTLANDING BATTERIES A,B,&C

The above items are for the CSM only. The following items relate to the LM only.

RCS A&B	XX(%)	PERCENTAGE OF USEABLE RCS REMAINING IN SYSTEM A & B
DESCENT O2	XXX(LBS)	AMOUNT OF O2 REMAINING IN THE DESCENT STAGE
DESCENT AMP-HRS	XXXX(Amp-Hrs)	NUMBER OF AMP-HRS REMAINING IN THE DESCENT STAGE BATTERIES
ASCENT AMP-HRS	XXX(Amp-Hrs)	NUMBER OF AMP-HRS REMAINING IN THE ASCENT STAGE BATTERIES

LM AOT STAR OBSERVATION

This update data is copied directly in the onboard crew checklist and, as such, there is no pad format. The following data is required:

GET		GROUND ELAPSED TIME OF STAR OBSERVATION
HR	XXX	
MIN	XX	
SEC	XX	
AOT DETENT		AOT DETENT POSITION TO BE USED
NAV STAR	XX(OCTAL)	NAV STAR TO BE USED FOR TEST
R	XXX(DEG)	INERTIAL CSM ROLL ANGLE
P	XXX(DEG)	INERTIAL CSM PITCH ANGLE
Y	XXX(DEG)	INERTIAL CSM YAW ANGLE

LM S-BAND STEERABLE UPDATE

This update data is copied directly in the onboard crew checklist and, as such, there is no pad format. The following data is required:

GET ACQ			GROUND ELAPSED TIME WHEN STATION ACQUISITION SHOULD OCCUR
HR	XXX		
MIN	XXX		
SEC	XXX		
FDAI INER			
R	XXX	} (DEG)	INERTIAL CSM FDAI ANGLES REQUIRED TO PLACE THE SPACECRAFT AT THE <u>TRACKING ATTITUDE</u>
P	XXX		
Y	XXX		
ANT @ T=0			
P	±XXX	} (DEG)	ANTENNA GIMBAL ANGLES REQUIRED TO PLACE ANTENNA BEAM ON STATION AT GET ACQ
Y	±XX		
ANT @ T+2			
P	+XXX	} (DEG)	ANTENNA GIMBAL ANGLES AT GET ACQ + 2 MIN
Y	±XX		
ANT @ T+4			
P	+XXX	} (DEG)	ANTENNA GIMBLE ANGLES AT GET ACQ + 4 MIN
Y	±XX		
ANT @ T+6			
P	+XXX	} (DEG)	ANTENNA GIMBLE ANGLES AT GET ACQ + 6 MIN
Y	±XX		

LM MANEUVER UPDATE

LM MANEUVER (P 30)

		PURPOSE			
+ 0 0	+ 0 0	HR	33	+ 0 0	
+ 0 0 0	+ 0 0 0	MIN	TIG	+ 0 0 0	
+ 0 .	+ 0 .	SEC		+ 0 .	

		$\Delta$ VX	37		
		$\Delta$ VY	LOCAL		
		$\Delta$ VZ	VERT		

+ .	+ .	$\Delta$ VR	42	+ .	
-----	-----	-------------	----	-----	--

		R	FDAI	18	
		P	INER		

		$\Delta$ VX	86		
		$\Delta$ VY	AGS		
		$\Delta$ VZ			

		AOTS			
		DETENT			
		AI			
		LINE ID			
		A2			

		COAS			
		AZ			
		EL			

REMARKS:



LM MANEUVER UPDATE

PURPOSE		PURPOSE OF MANEUVER (SUCH AS DOCKED DPS, PHASING, INSERTION)
TIG		<u>IGNITION TIME</u> FOR THE MANEUVER
HR	XXX	
MIN	XX	
SEC	XX.XX	
LOCAL VERT		
$\Delta VX$	$\pm XXXX.X(fps)$	LOCAL VERTICAL $\Delta V$ COMPONENTS OF THE MANEUVER
$\Delta VY$	$\pm XXXX.X(fps)$	
$\Delta VZ$	$\pm XXXX.X(fps)$	
$\Delta VR$	$XXXX.X(fps)$	TOTAL $\Delta V$ REQUIRED FOR THE MANEUVER
FDAI INER		
R	XXX (DEG)	INERTIAL FDAI ANGLES AT THE
P	XXX (DEG)	BURN ATTITUDE
$\Delta VX$ AGS	$\pm XXXX.X(fps)$	LOCAL VERTICAL $\Delta V$ COMPONENTS OF THE MANEUVER USED TO TARGET THE AGS; ROTATED THROUGH THE HALF-ANGLE OF THE BURN
$\Delta VY$ AGS	$\pm XXXX.X(fps)$	
$\Delta VZ$ AGS	$\pm XXXX.X(fps)$	
AOTS	XX(OCTAL)	IDENTIFIER FOR AOT STAR USED TO VERIFY SPACECRAFT ATTITUDE AT THE BURN ATTITUDE
DETENT	X	AOT DETENT FOR STAR CHECK
A1	XXX(DEG)	ANGLE READOUT WHEN THE AOT RETICLE LINE IDENTIFIED BELOW IS PLACED ON THE AOTS
LINE ID	X	IDENTIFIER OF THE AOT RETICLE LINE TO BE USED WITH A1

LM MANEUVER UPDATE (cont'd)

A2	XXX(DEG)	ANGLE READOUT WHEN THE AOT RETICLE SPIRAL IS PLACED ON THE AOTS
COAS	XX(OCTAL)	IDENTIFIER FOR COAS STAR USED TO VERIFY SPACECRAFT ATTITUDE AT THE BURN ATTITUDE
AZ	XXX } XXX }	THE AZIMUTH AND ELEVATION ANGLES OF THE COAS STAR
EL		

NOTE: THE P30 PAD FOR PHASING WILL CONTAIN A TPI<sub>0</sub> TIG IN  
THE REMARKS

LM CSI MANEUVER UPDATE

CSI UPDATE (P32)

+ 0 0	+ 0 0	HR	30	+ 0 0
+ 0 0 0	+ 0 0 0	MIN	TIG	+ 0 0 0
+ 0 .	+ 0 .	SEC	CSI	+ 0 .

+ 0 0	+ 0 0	HR	37	+ 0 0
+ 0 0 0	+ 0 0 0	MIN	TIG	+ 0 0 0
+ 0 .	+ 0 .	SEC	TPI	+ 0 .

MSFN

0 0 .	0 0 .	ΔVX LOCAL	81	0 0 .
0 0 .	0 0 .	ΔVY VERT		0 0 .

		PLM	FDAI	18
--	--	-----	------	----

0 0 .	0 0 .	ΔVX	AGS	86	0 0 .
0 0 .	0 0 .	ΔVZ			0 0 .

PGNCS

CHARTS

0 0 .	0 0 .	ΔVX LOCAL	81
0 0 .		ΔVY VERT	
0 0 .		ΔVZ	

BIAS: TIG (TPI) = TIG (MSFN) + 2:00

REMARKS:

---:---  
 2:00  
 ---:---

CSI UPDATE

TIG CSI

IGNITION TIME FOR THE  
CSI MANEUVER

HR                   XXX  
MIN                   XX  
SEC                   XX.XX

TIG TPI

IGNITION TIME FOR THE  
TPI MANEUVER

HR.....XXX  
MIN                   XX  
SEC                   XX.XX

LOCAL VERT

$\Delta V_X$                 $\pm XX.X$  (fps) }  
 $\Delta V_Y$                 $\pm XX.X$  (fps) }

LOCAL VERTICAL  
 $\Delta V$  COMPONENTS  
OF THE CSI  
MANEUVER

PLM FDAI             XXX (DEG)

LM FDAI INERTIAL  
PITCH ANGLE AT  
CSI BURN ATTITUDE

$\Delta V_X$  AGS ..... $\pm XX.X$  (fps)

$\Delta V_Z$  AGS            $\pm XX.X$  (fps)

Local vertical  $\Delta V$   
COMPONENTS OF CSI  
USED TO TARGET AGS  
EXT  $\Delta V$ ; ROTATED  
THROUGH THE HALF-ANGLE  
OF THE BURN

Below the double line is for onboard use only.

LM CDH MANEUVER UPDATE

CDH UPDATE (P33)

+ 0 0	+ 0 0	HR	TIG <b>31</b>	+ 0 0
+ 0 0 0	+ 0 0 0	MIN	CDH	+ 0 0 0
+ 0	+ 0	SEC		+ 0

MSFN

0 0 .	0 0 .	ΔVX	LOCAL <b>81</b>	0 0 .
0 0 .	0 0 .	ΔVY	VERT	0 0 .
0 0 .	0 0 .	ΔVZ		0 0 .

		PLM	FDAI <b>18</b>	
--	--	-----	----------------	--

0 0 .	0 0 .	ΔVX	AGS <b>86</b>	0 0 .
0 0 .	0 0 .	ΔVZ		0 0 .

PGNCS

CHARTS

0 0 .	0 0 .	ΔVX	LOCAL <b>81</b>
0 0 .	0 0 .	ΔVY	VERT
0 0 .	0 0 .	ΔVZ	

BIAS: TIG (CDH) = TIG (PGNCS) + 1:50

REMARKS:

----- : ----- : -----  
 ----- : 1 : 5 0 : -----  
 ----- : ----- : -----

CDH UPDATE

TIG CDH ..... IGNITION TIME FOR THE  
CDH MANEUVER

HR                   XXX  
MIN                   XX  
SEC                   XX.XX

LOCAL VERT

$\Delta V_X$                 $\pm XX.X$  (fps) }  
 $\Delta V_Y$                 $\pm XX.X$  (fps) } LOCAL VERTICAL  $\Delta V$   
 $\Delta V_Z$                 $\pm XX.X$  (fps) } COMPONENTS OF  
THE CDH MANEUVER

PLM FDAI             XXX (DEG)   LM FDAI INERTIAL  
PITCH ANGLE AT  
CDH BURN ATTITUDE

$\Delta V_X$  AGS            $\pm XX.X$  (fps) }  
 $\Delta V_Z$  AGS            $\pm XX.X$  (fps) } LOCAL VERTICAL  $\Delta V$   
USED TO TARGET AGS  
EXT  $\Delta V$ ; ROTATED  
THROUGH THE HALF-ANGLE  
OF THE BURN

Below the double line for onboard use only.

LM TPI MANEUVER UPDATE

TPI UPDATE (P34)					
+ 0 0	+ 0 0	HR	<b>37</b>	+ 0 0	
+ 0 0 0	+ 0 0 0	MIN	TIG	+ 0 0 0	
+ 0	+ 0	SEC	TPI	+ 0	
0 0	0 0	ΔVX	<b>81</b>	0 0	
0 0	0 0	ΔVY	LOCAL	0 0	
0 0	0 0	ΔVZ	VERT	0 0	
+ 0 0	+ 0 0	ΔVR	<b>42</b>	+ 0 0	
		RLM	FDAI <b>18</b>		
		PLM	INER		
+ 0	+ 0	R TPI	<b>54</b>	+ 0	
0	0	R TPI		0	
<b>MSFN</b>					
0 0	0 0	F/A (+/-)	<b>59</b>	0 0	
0 0	0 0	L/R (-/+)	ΔV	0 0	
0 0	0 0	U/D (-/+)	LOS	0 0	
<hr/>					
<b>PGNCS</b>		<b>CHARTS</b>			
0 0	0 0	F/A	ΔV	<b>59</b>	
0 0	0 0	L/R	LOS		
0 0	0 0	U/D			
<b>REMARKS:</b>					

TPI UPDATE

TIG TPI

IGNITION TIME FOR  
THE TPI MANEUVER

HR XXX

MIN XX

SEC XX.XX

LOCAL VERT

$\Delta V X$   $\pm XX.X$  (fps)

$\Delta V Y$   $\pm XX.X$  (fps)

$\Delta V Z$   $\pm XX.X$  (fps)

$\Delta AVR$  XX.X (fps)

LOCAL VERTICAL  $\Delta V$   
COMPONENTS OF THE  
TPI MANEUVER

TOTAL  $\Delta V$  REQUIRED  
FOR THE MANEUVER

FDAI INER

R LM XXX (DEG)

P LM XXX (DEG)

R TPI XX.XX (ft)

R TPI  $\pm XXX.X$  (fps)

LM FDAI ROLL & PITCH  
ANGLE AT TPI BURN  
ATTITUDE

RANGE AT TPI TIG -5 MIN

RANGE RATE AT TPI TIG -5 MIN

$\Delta V$  LOS

F/A F/AXX.X(fps)

L/R L/RXX.X(fps)

U/D U/DXX.X(fps)

LINE-OF-SIGHT  $\Delta V$   
COMPONENTS OF THE  
TPI MANEUVER

Below the double line is for onboard use only.





LM P27 UPDATE

V	XX	TYPE OF COMMAND LOAD (70 - 71 - 72 - 73)
PURP		TYPE OF DATA TO BE RECEIVED (SUCH AS: NAV. LIFT-OFF TIME)
01	XX	INDEX NO. OF COMMAND WORDS IN LOAD (OCTAL)
02-24	XXXXX	COMMAND WORDS (OCTAL)
NAV. CHECK	_____	SPACECRAFT POSITION RELATIVE TO THE EARTH AT A GIVEN TIME

(NOTE: 306 - 331 ARE THE UPBUFF REGISTERS)

T	XXX:XX:XX (HR:MIN:SEC)	GET OF NAV CHECK
$\phi$	$\pm$ XXX.XX (DEG)	LATITUDE
$\lambda$	$\pm$ XXX.XX (DEG)	LONGITUDE
h	XXXX.X	ALTITUDE

LM AGS STATEVECTOR UPDATE

AGS STATE VECTOR UPDATE										
1	2	4	0	<input type="checkbox"/>		2	4	0	<input type="checkbox"/>	
2	2	4	1	<input type="checkbox"/>		2	4	1	<input type="checkbox"/>	
3	2	4	2	<input type="checkbox"/>		2	4	2	<input type="checkbox"/>	
4	2	6	0	<input type="checkbox"/>		2	6	0	<input type="checkbox"/>	
5	2	6	1	<input type="checkbox"/>		2	6	1	<input type="checkbox"/>	
6	2	6	2	<input type="checkbox"/>		2	6	2	<input type="checkbox"/>	
7	2	5	4	+		2	5	4	+	
10	2	4	4	<input type="checkbox"/>		2	4	4	<input type="checkbox"/>	
11	2	4	5	<input type="checkbox"/>		2	4	5	<input type="checkbox"/>	
12	2	4	6	<input type="checkbox"/>		2	4	6	<input type="checkbox"/>	
13	2	6	4	<input type="checkbox"/>		2	6	4	<input type="checkbox"/>	
14	2	6	5	<input type="checkbox"/>		2	6	5	<input type="checkbox"/>	
15	2	6	6	<input type="checkbox"/>		2	6	6	<input type="checkbox"/>	
16	2	7	2	+		2	7	2	+	
REMARKS										

AGS STATE VECTOR UPDATE

PURP





PURPOSE FOR AGS STATE  
VECTOR UPDATE

1 - 16

XXXXX

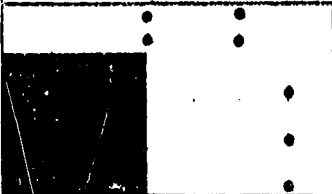
OCTAL AGS STATE VECTOR  
COMPONENTS

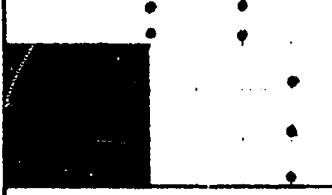
CSM & LM GIMBAL ANGLE UPDATE

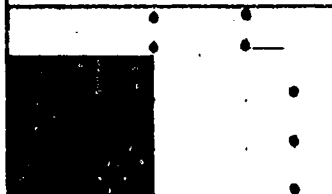
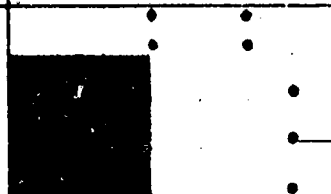
GIMBAL ANGLE UPDATE		
		GET R P Y PURP
		GET R P Y PURP
		GET R P Y PURP

GIMBAL ANGLE UPDATE

G.E.T.	XXX:XX:XX (HR-MIN-SEC)	TIME WHEN SPACECRAFT IS TO MANEUVER TO THE UPDATED GIMBAL ANGLES
R	XXX.X (DEG)	ROLL ANGLE
P	XXX.X (DEG)	PITCH ANGLE
Y	XXX.X (DEG)	YAW ANGLE

SECTION 3 - DETAILED TIMELINE

SECTION 3

EOLDOUT FRAME

APOLLO 9 SUMMARY FLIGHT P

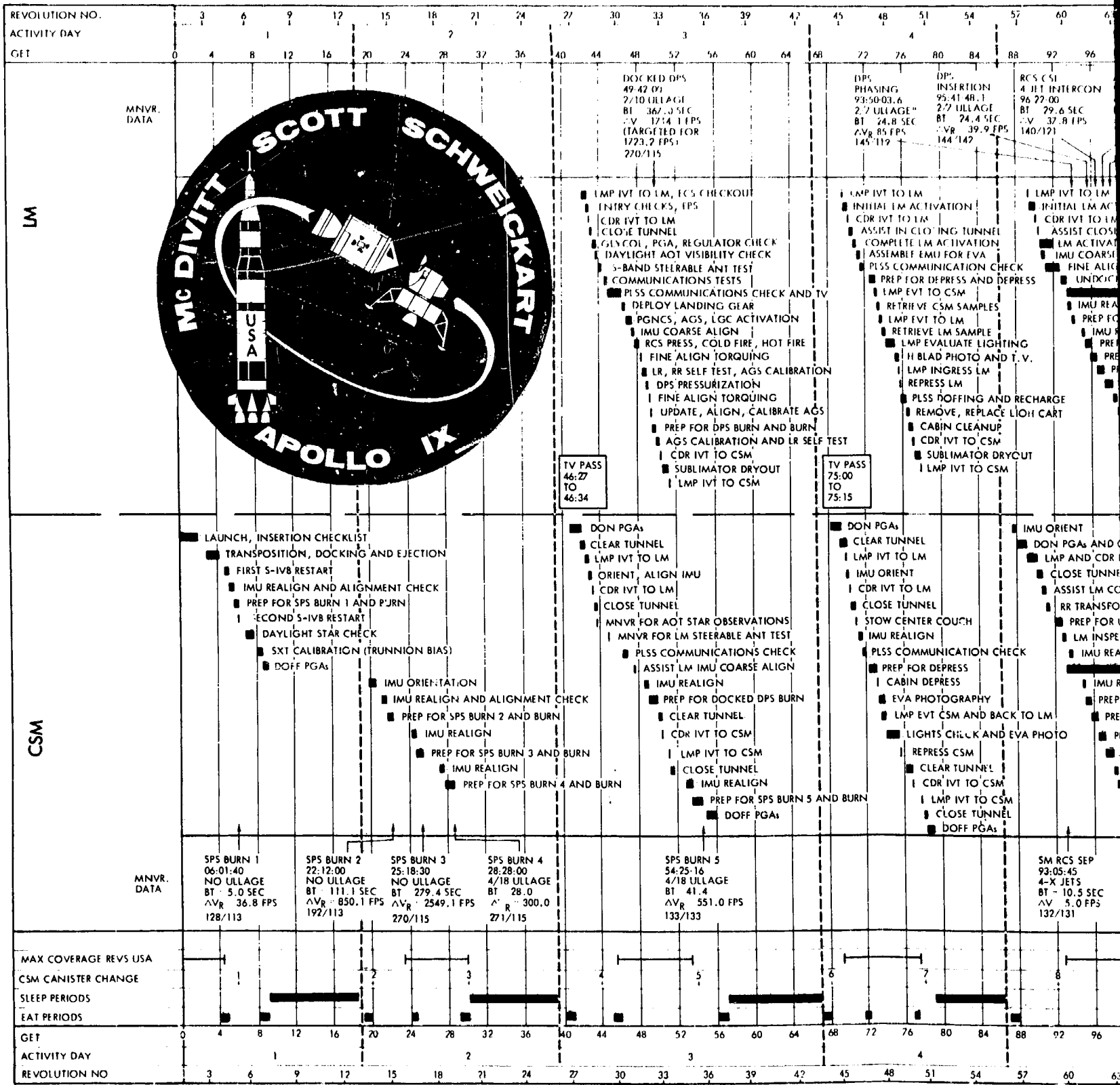



# 9 SUMMARY FLIGHT PLAN

# FOLDOUT FRAME 2

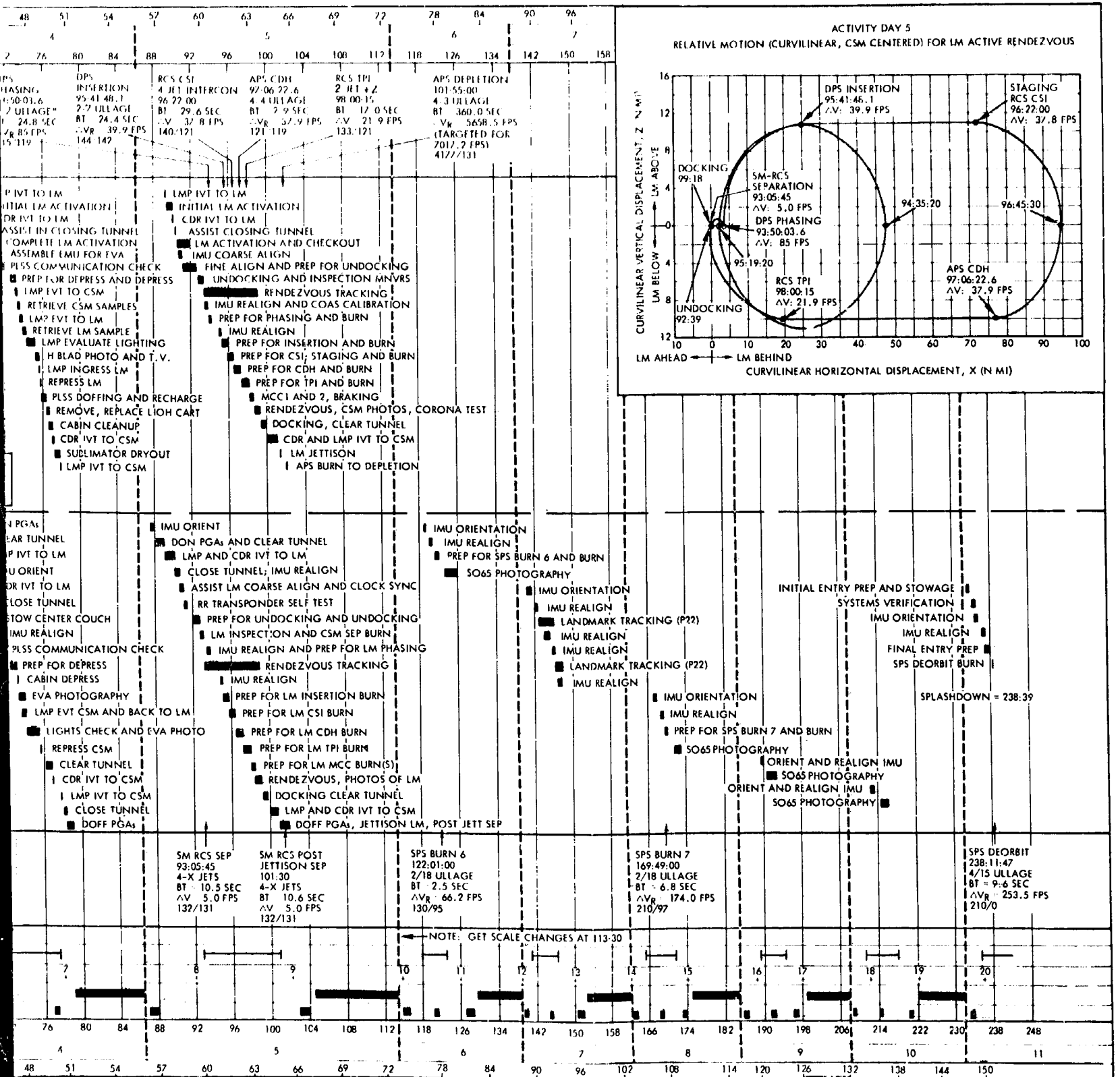

BURN SCHEDULE

Burn	GETI Burn Time	LH Att wrt Orbit Plane	Head Position wrt Orb Plane Lighting	$\Delta V$ (LV/LH) $\Delta V_R$	Utlage $\Delta V$	TVC Post Burn Orbit	Pilot (Left Position)	Vehicle Weight at GETI	Remarks
SM-RCS Exeasive Mavr	04:11:27.9 BT : 3.0		SR+4 min	$\Delta V = 0.4$		112/106	CMP	CSM = 58,877 LM = 31,995 Total = 90,872	4 Jet Burn
CSM SPS Burn 1	06:01:40 BT : 5.0	R = 0.0 P = +1.0 Y = -0.7	Up SR+27 min	$\Delta V_X = +36.8$ $\Delta V_Y = 0.0$ $\Delta V_Z = 0.0$ $\Delta V_R = 36.8$	0	G4N	CDR	CSM = 58,856 LM = 31,995 Total = 90,851	
CSM SPS Burn 2	22:12:00 BT : 111.1	R = 0.0 P = +1.8 Y = -83.7	Up SR+20 min	$\Delta V_X = +102.1$ $\Delta V_Y = -843.8$ $\Delta V_Z = -14.4$ $\Delta V_R = 850.1$	0	G4N	CMP	CSM = 58,459 LM = 31,995 Total = 90,454	
CSM SPS Burn 3	25:18:30 BT : 279.4	R = 0.0 P = +1.4 Y = -90.3	Up SR+28 min	$\Delta V_X = +13.9$ $\Delta V_Y = -2549.0$ $\Delta V_Z = -16.7$ $\Delta V_R = 2549.1$	0	G4N with MITVC 270/115	CMP	CSM = 51,104 LM = 31,995 Total = 83,099	
CSM SPS Burn 4	28:28:00 BT : 28.0	R = 0.0 P = +0.7 Y = -90.2	Up SR+36 min	$\Delta V_X = -0.7$ $\Delta V_Y = -300.0$ $\Delta V_Z = +1.2$ $\Delta V_R = 300.0$	4 Jet 18 sec $\Delta V = 3.6$	G4N 271/115	CMP	CSM = 32,467 LM = 31,995 Total = 64,462	LM DOCKED DPS CSM Att wrt to Orbit Plane (LH/LV): R = +120.0, P = -0.3 Y = -188.1
LM Docked DPS Burn	49:42:00 BT : 367.0	R = 0.0 P = 0.3 Y = -91.9	Face up SR+29 min	$\Delta V_X = -57.2$ $\Delta V_Y = -1722.3$ $\Delta V_Z = 9.2$ $\Delta V_R = 1723.2$	2 Jet 10 sec $\Delta V = 1.0$	PGNCS with manual Ramp 270/115	CDR	CSM = 30,585 LM = 31,995 Total = 62,580	LM targeted for 374 sec to allow for manual cutoff. Actual $\Delta V_R = 1714.1$ fps
CSM SPS Burn 5	54:25:16 BT : 41.4	R = 0.0 P = -37.5 Y = -120.3	Up SR+39 min	$\Delta V_X = -208.4$ $\Delta V_Y = 341.9$ $\Delta V_Z = 349.2$ $\Delta V_R = 551.0$	4 Jet 16 sec $\Delta V = 4.5$	G4N 133/133	CDR	CSM = 30,476 LM = 21,878 Total = 52,354	
SM RCS Separation Burn	93:05:45 BT : 10.5	R = +17.3 P = +89.4 Y = +17.3	Face up SR+38 min	$\Delta V = 5.0$		G4N 132/131	CMP	CSM = 27,282 LM = 22,302	4 Jet Burn
LM DPS Phasing	93:50:03.6 BT : 24.8	R = -6.5 P = +84.8 Y = -6.5	SR-7 min	$\Delta V_X = +1.3$ $\Delta V_Y = 0.0$ $\Delta V_Z = -85.0$ $\Delta V_R = 85.0$	2 Jet 7 sec $\Delta V = 2.0$	ACS 145/119	CDR	LM = 22,121 CSM = 27,267	
LM DPS Insertion	95:41:48.1 BT : 24.4	R = 0.0 P = -0.7 Y = 0.0	Face up SR+15 min	$\Delta V_X = +39.9$ $\Delta V_Y = 0.0$ $\Delta V_Z = +0.5$ $\Delta V_R = 39.9$	2 Jet 7 sec $\Delta V = 2.1$	PGNCS 10% 144/142	CDR	LM = 21,811 CSM = 27,267	

BURN SCHEDULE (CONT)

Burn	GETI Burn Time	LH Att wrt Orbit Plane	Head Position wrt Orb Plane Lighting	AV (LVLH) ΔV <sub>R</sub>	Ullage ΔV	TVC Post Burn Orbit	Pilot (Left Position)	Vehicle Weight at GETI	Remarks
LM RCS CSI	96:22:00.0 BT : 29.6	R : 0.0 P : +1.0 Y : +180.0	Face up SR+55 min	ΔVX : -37.8 ΔVY : 0.0 ΔVZ : 0.0 ΔV <sub>R</sub> : 37.8		PGNCS 140/121	CDR	LM : 10,106 (staged) CSM : 22,267	LM weight unstaged : 21,576
LM APS CDH	97:06:22.6 BT : 2.9	R : 0.0 P : +2.3 Y : +180.0	Face up SR+11 min	ΔVX : -37.8 ΔVY : 0.0 ΔVZ : -1.5 ΔV <sub>R</sub> : 37.9	4 Jet 4 sec ΔV : 5.1	PGNCS Ext ΔV 121/119	CDR	LM : 10,040	
LM RCS TPI	98:00:15 BT : 17.0	R : 0.0 P : +26.4 Y : 0.0	Face up SR-10 min	ΔV : 21.9		PGNCS Lambert 133/121	CDR	LM : 9,971	
SM RCS Post Jettison Separation	101:30 BT : 10.6	R : 0.0 P : 0.0 Y : +90.0	SR+6 min	ΔVX : 0.0 ΔVY : 5.0 ΔVZ : 0.0 ΔV <sub>R</sub> : 5.0			CMP	LM : 9,324 CSM : 27,711	4 Jet Burn
LM APS Depletion	101:55:00 BT : 360.0	R : 0.0 P : -14.1 Y : -46.7	SR+31 min	ΔVX : +4969.8 ΔVY : -4953.8 ΔVZ : +47.2 ΔV <sub>R</sub> : 7017.2	4 Jet 3 sec ΔV : 4.1	PGNCS Ext ΔV 4177/131		LM : 9,319	LM Targeted for 422 sec to allow for propellant depletion. Actual ΔV <sub>R</sub> = 5,658.5 fps
CSM SPS Burn 6	122:01:00 BT : 2.5	R : 0.0 P : +19.5 Y : +180.0	Up SR-11 min	ΔVX : -63.5 ΔVY : 0.0 ΔVZ : -18.8 ΔV <sub>R</sub> : 66.2	2 Jet 18 sec ΔV : 4.3	G&N 130/95	CMP	CSM = 27,482	
CSM SPS Burn 7	169:49:00 BT : 6.8	R : 0.0 P : +27.5 Y : +0.6	Up SR+27 min	ΔVX : +157.8 ΔVY : -0.2 ΔVZ : -73.4 ΔV <sub>R</sub> : 174.0	2 Jet 18 sec ΔV : 4.3	G&N 210/97	CDR	CSM = 27,157	
CSM SPS Deorbit	238:11:47 BT : 9.6	R : 0.0 P : -47.0 Y : -180.0	Up SR-2 min	ΔVX : -162.4 ΔVY : +0.1 ΔVZ : +194.7 ΔV <sub>R</sub> : 253.5	4 Jet 15 sec ΔV : 7.4	G&N 210/0	CDR	CSM = 26,512	

# FLIGHT PLAN

TIME	EVENT	REMARKS
-00:09	LCC: <u>REPORT IGNITION</u>	NOMINAL LIFT-OFF 1600 GMT
00:00	LCC: <u>REPORT LIFT-OFF</u>	L/O LIGHT, ENGINE LIGHTS OFF
00:02	CDR: <u>REPORT CLOCK START</u> YAW MANEUVER	UMBILICAL DISCONNECT, T <sub>1</sub> = 0
00:10	LCC: <u>REPORT CLEAR OF TOWER</u>	
00:12	CDR: <u>REPORT ROLL &amp; PITCH START</u>	
00:31	ROLL COMPLETE	
00:42	MCC: <u>REPORT MODE 1B</u>	PRPLANT DUMP - RCS CMD
	CDR: <u>REPORT MODE 1B</u>	
01:21	MAX Q	
01:54	MCC: <u>REPORT MODE 1C</u>	h = 100,000 ft (16.5 nm)
	CDR: <u>REPORT MODE 1C</u>	
02:00	CMP: <u>REPORT EDS AUTO - OFF</u>	EDS ENG & RATES - OFF
	MCC: <u>REPORT GO/NO GO FOR STAGING</u>	
	CDR: <u>REPORT GO/NO GO FOR STAGING</u>	
02:14	CDR: <u>REPORT INBOARD CUTOFF</u>	
02:40	CDR: <u>REPORT OUTBOARD CUTOFF</u>	
	SIC/S-II STAGING	
02:44	S-II 65%	
03:10	CDR: <u>REPORT S-II SEP LTS - OUT</u>	
03:16	CMP: <u>REPORT TOWER JETT &amp; MODE II</u>	
	MCC: <u>REPORT MODE II</u>	
03:20	CDR: <u>REPORT GUIDANCE INITIATE</u>	
04:00	MCC: <u>REPORT TRAJECTORY GO/NO GO</u>	
MISSION APOLLO 9		
EDITION FINAL		
DATE FEBRUARY 3, 1969		PAGE 3-1

# FLIGHT PLAN

TIME	EVENT	REMARKS
04:00	CDR: <u>REPORT STATUS</u>	
05:00	CDR: <u>REPORT STATUS</u>	
05:53	MCC: <u>REPORT S-IVB TO ORBIT CAPABILITY</u>	
06:00	CDR: <u>REPORT STATUS</u>	
06:30	MCC: <u>REPORT TIME OF LEVEL SENSE ARM &amp; S-II CUTOFF</u>	
07:00	CDR: <u>REPORT STATUS</u>	
08:00	CDR: <u>REPORT STATUS</u>	
08:20	MCC: <u>REPORT GO/NO GO FOR STAGING</u>	
	CDR: <u>REPORT GO/NO GO FOR STAGING</u>	
08:54	S-II CUTOFF	
	S-II/S-IVB STAGING	
08:55	S-IVB IGNITION	
08:58	S-IVB 65%	
	CDR: <u>REPORT STATUS</u>	
09:45	MCC: <u>REPORT MODE IV</u>	
	CDR: <u>REPORT MODE IV</u>	
10:00	CDR: <u>REPORT GO/NO GO FOR ORBIT</u>	
10:49	CDR: <u>REPORT S-IVB CUTOFF</u>	
		T <sub>5</sub> = 0

# FLIGHT PLAN

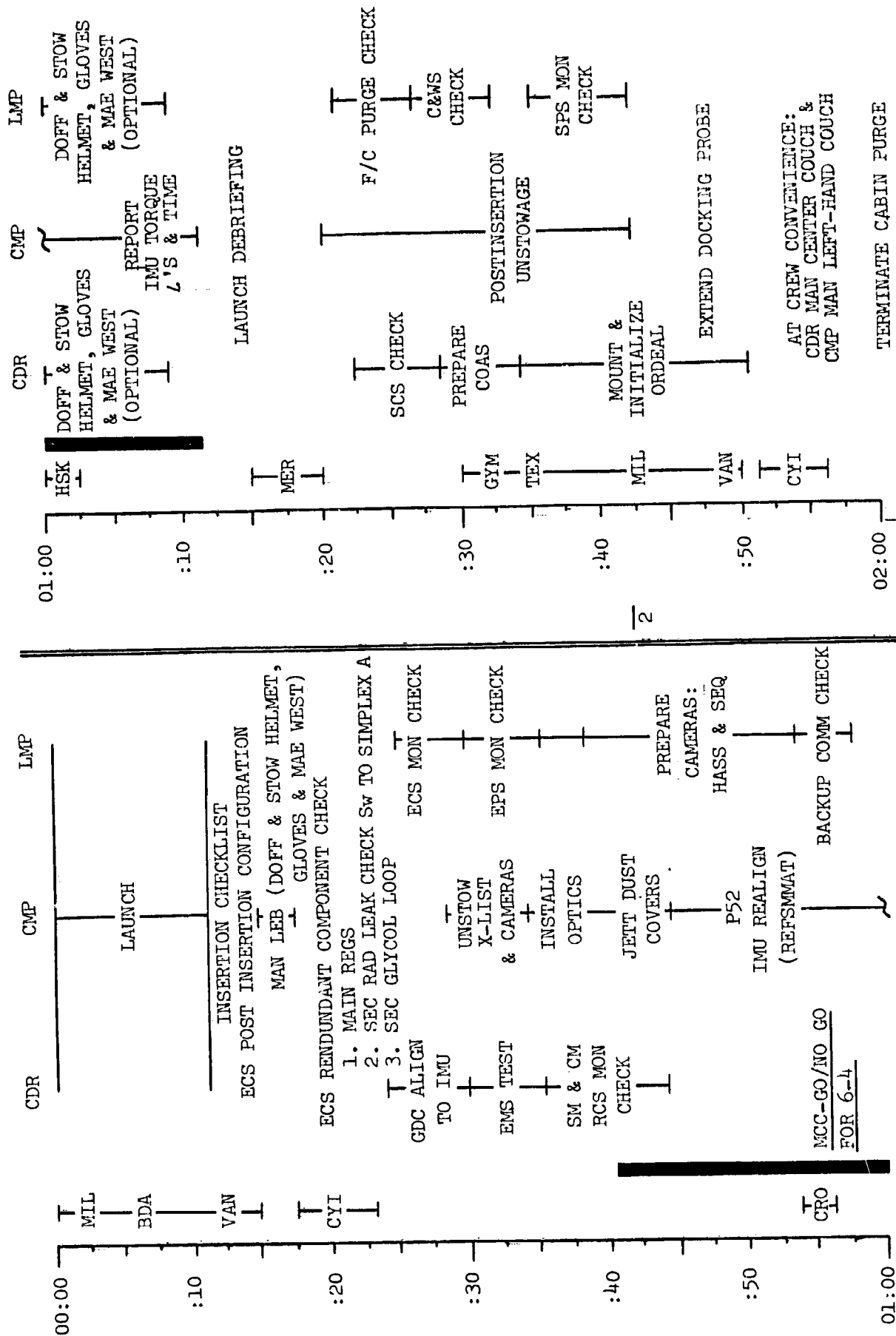

MISSION	EDITION	DATE	TIME	DAY/REV	PAGE
APOLLO 9	FINAL	FEBRUARY 3, 1969	00:00 - 02:00	1/1-2	3-3

# FLIGHT PLAN

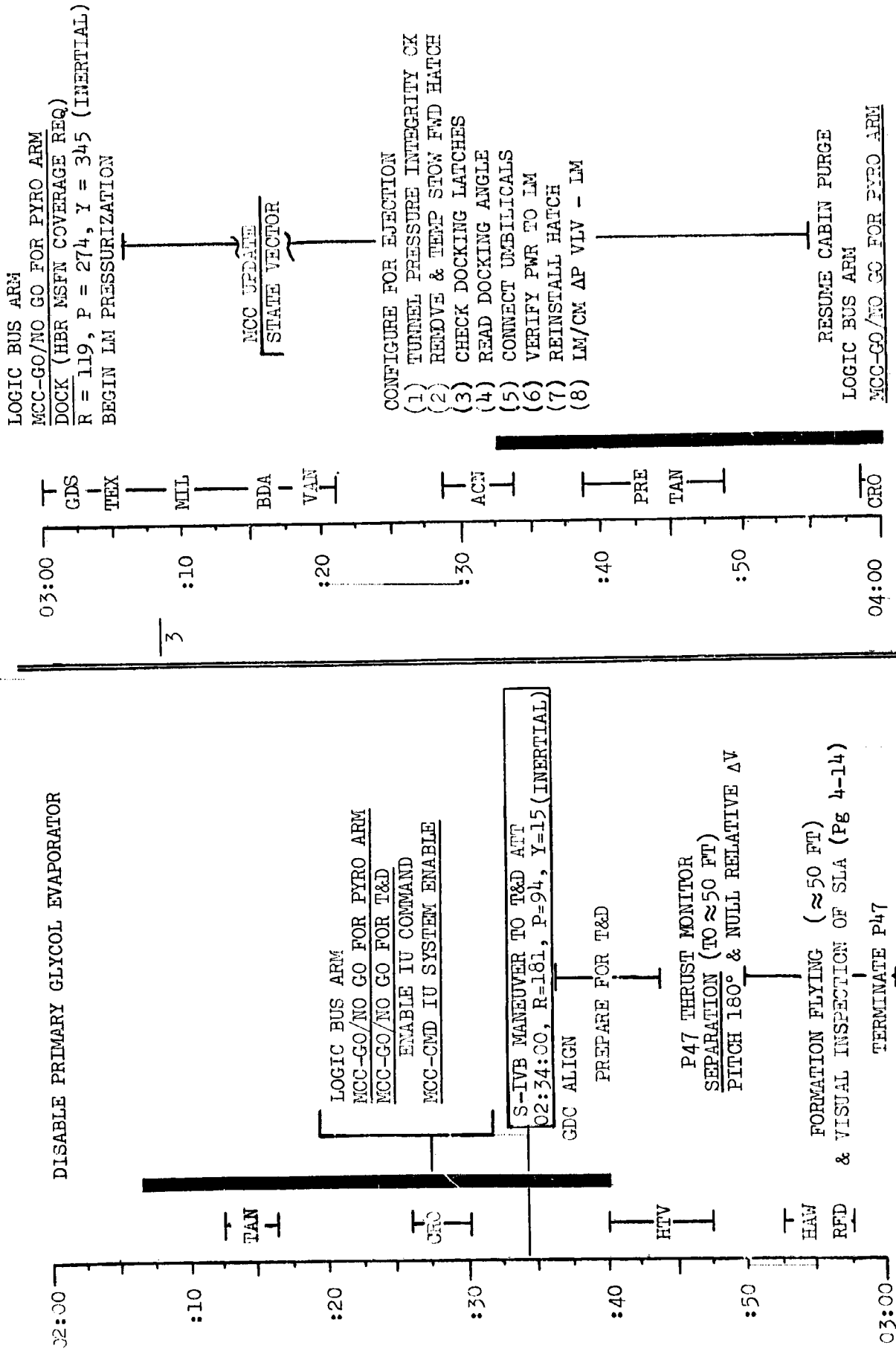

MISSION	EDITION	DATE	TIME	DAY/REV	PAGE
APOLLO 9	FINAL	FEBRUARY 3, 1969	02:00 - 04:00	1/2-3	3-4

# FLIGHT PLAN

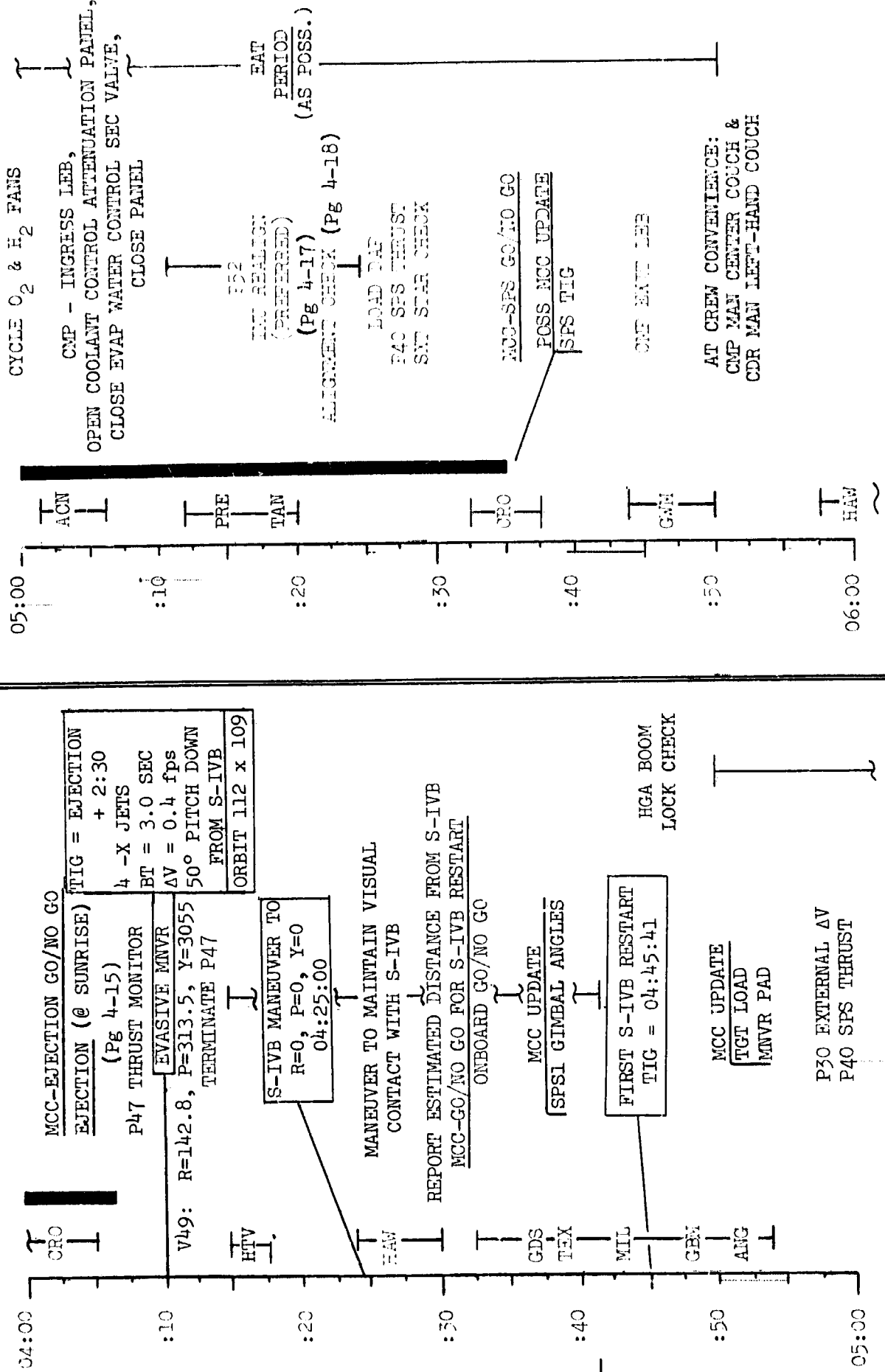

MISSION	EDITION	DATE	TIME	DAY/REV	PAGE
APOLLO 9	FINAL	FEBRUARY 3, 1969	04:00 - 06:00	1/3-4	3-5



# FLIGHT PLAN

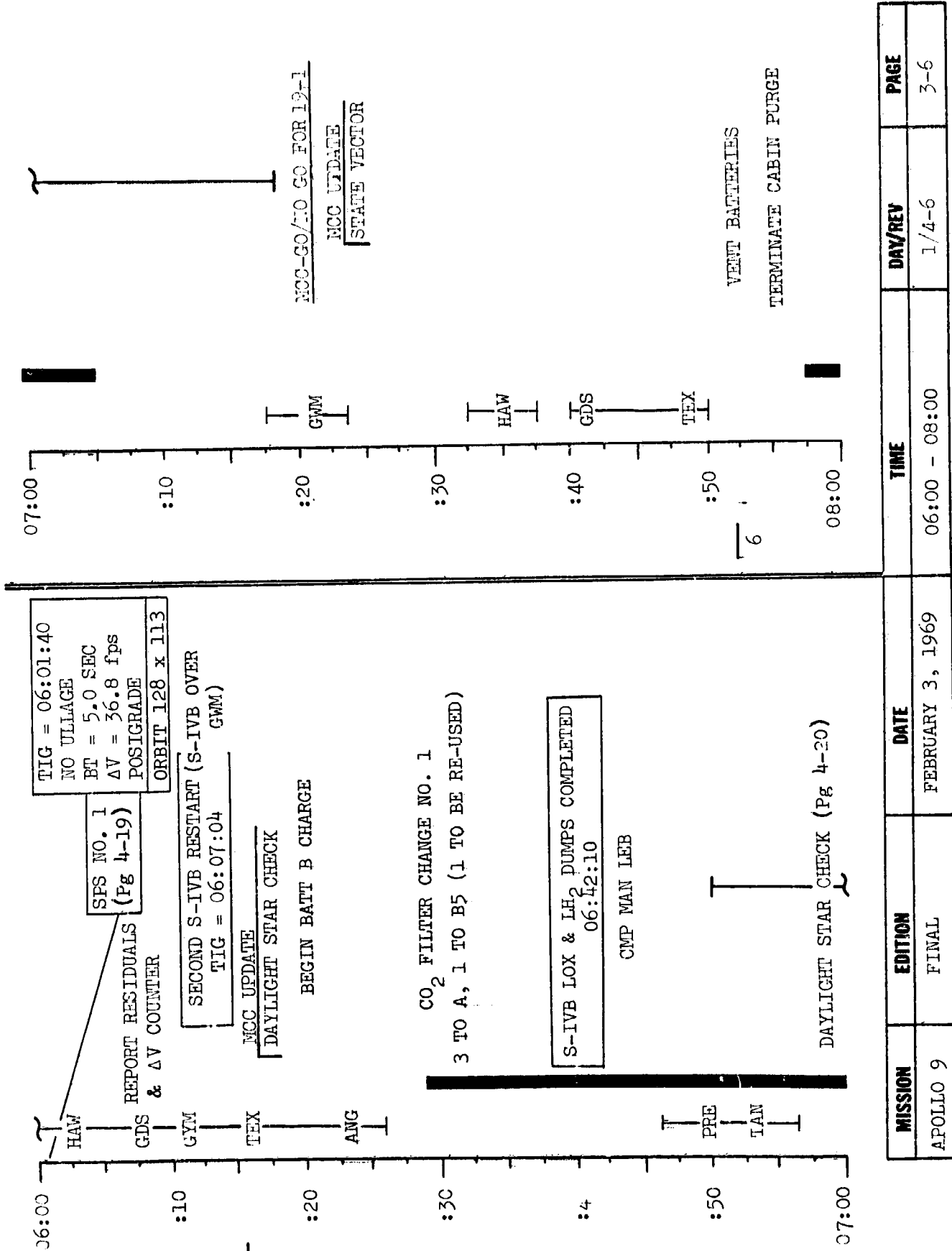

# FLIGHT PLAN

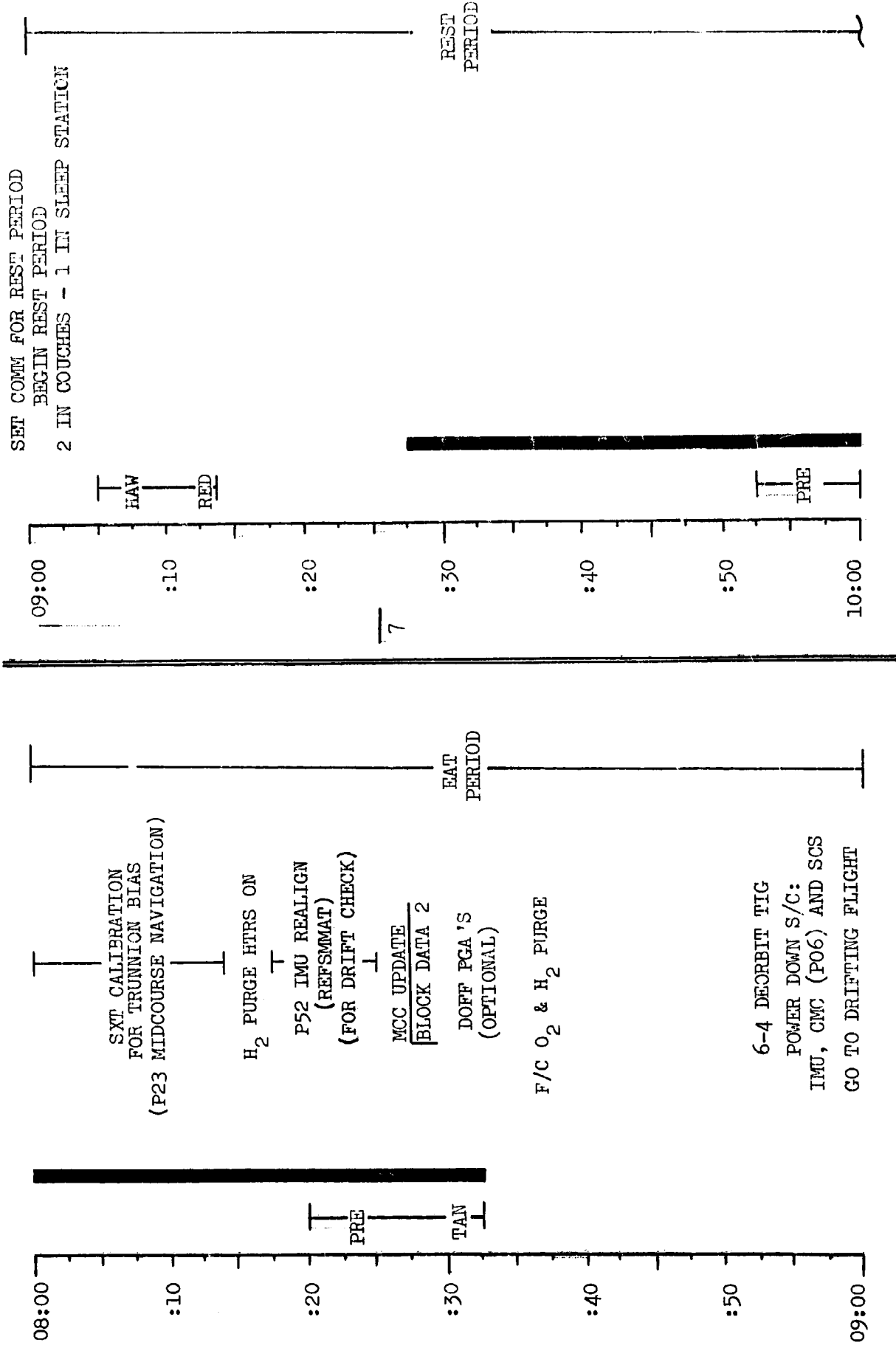

SET COM for REST PERIOD  
 BEGIN REST PERIOD  
 2 IN COUCHES - 1 IN SLEEP STATION

MISSION	EDITION	DATE	TIME	DAY/REV	PAGE
APOLLO 9	FINAL	FEBRUARY 3, 1969	08:00 - 10:00	1/6-7	3-7

# FLIGHT PLAN

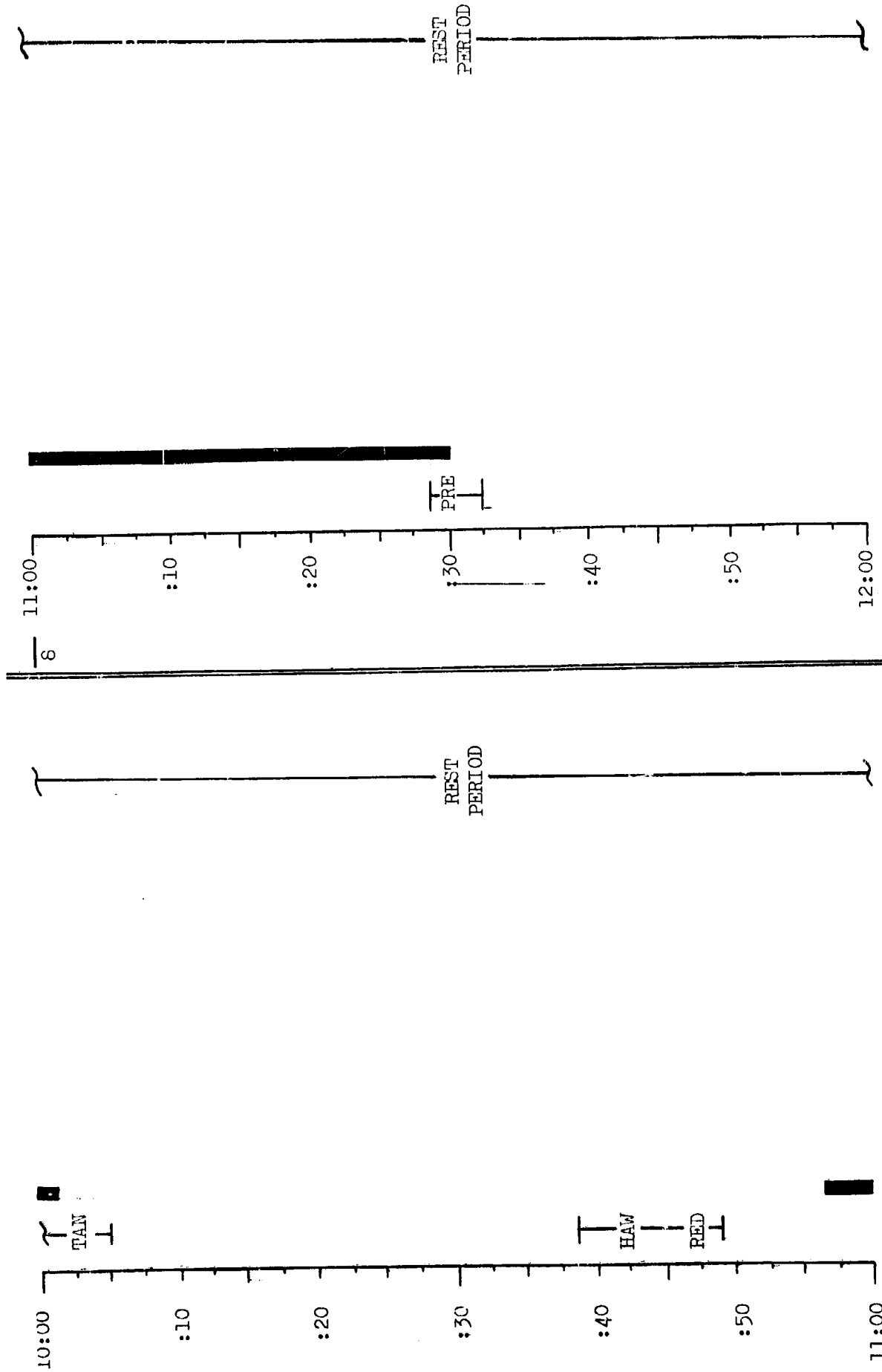

MISSION	EDITION	DATE	TIME	DAY/REV	PAGE
APOLLO 9	FINAL	FEBRUARY 3, 1969	10:00 - 12:00	1/7-8	3-8

# FLIGHT PLAN

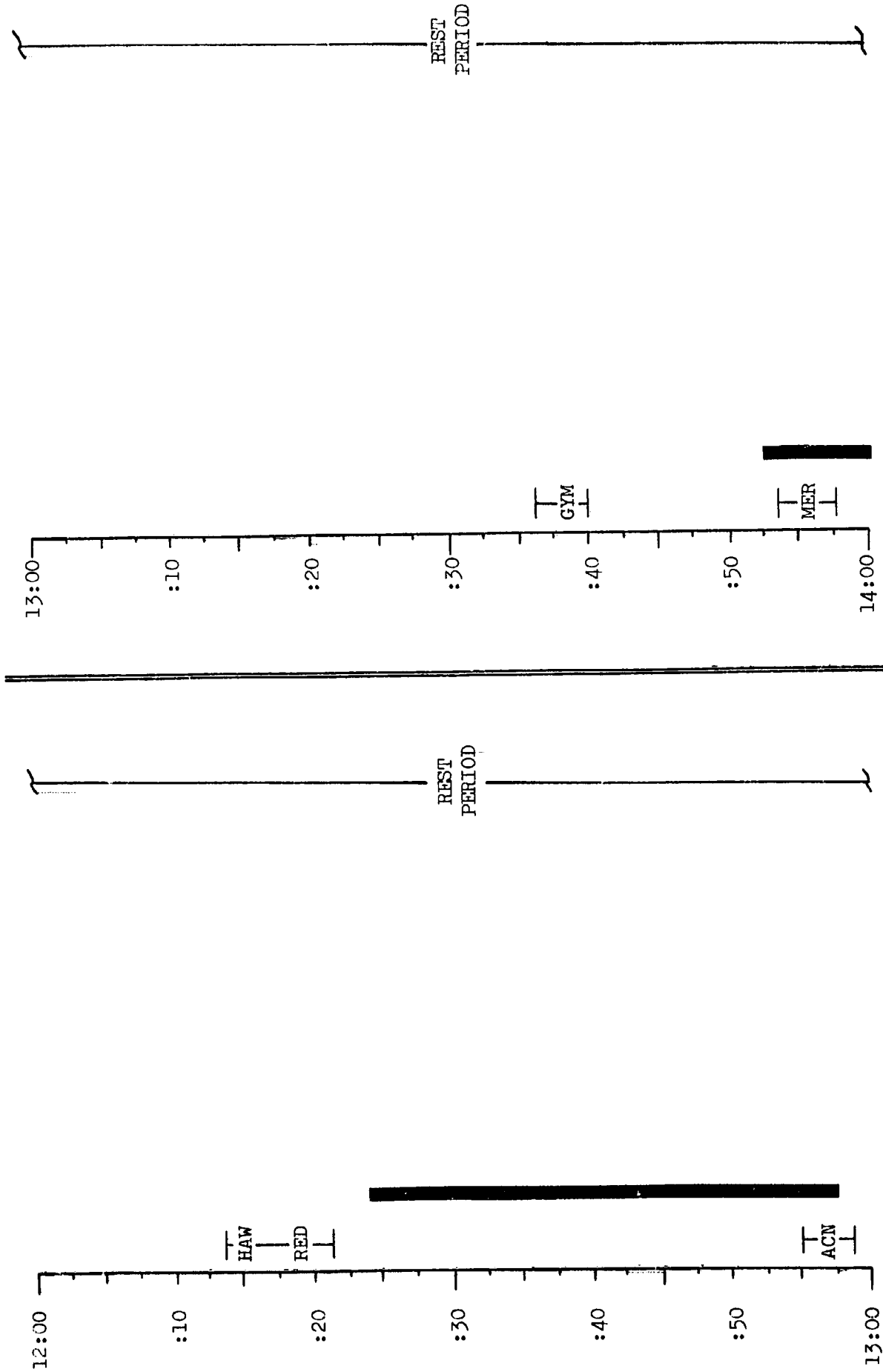

MISSION	EDITION	DATE	TIME	DAY/REV	PAGE
APOLLO 9	FINAL	FEBRUARY 3, 1969	12:00 - 14:00	1/8-9	3-9

# FLIGHT PLAN

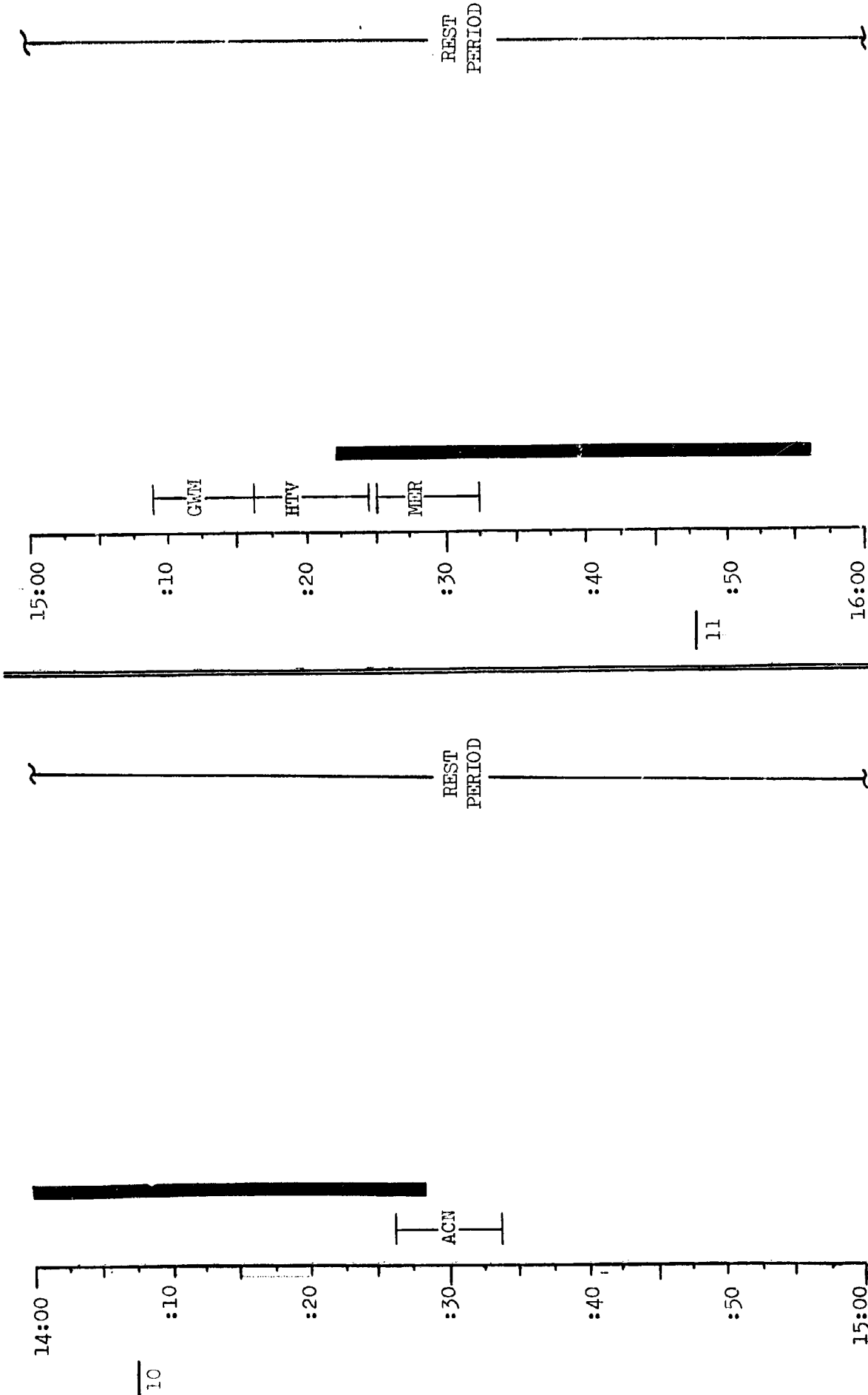

MISSION	EDITION	DATE	TIME	DAY/REV	PAGE
APOLLO 9	FINAL	FEBRUARY 3, 1969	14:00 - 16:00	1/9-11	3-10

# FLIGHT PLAN

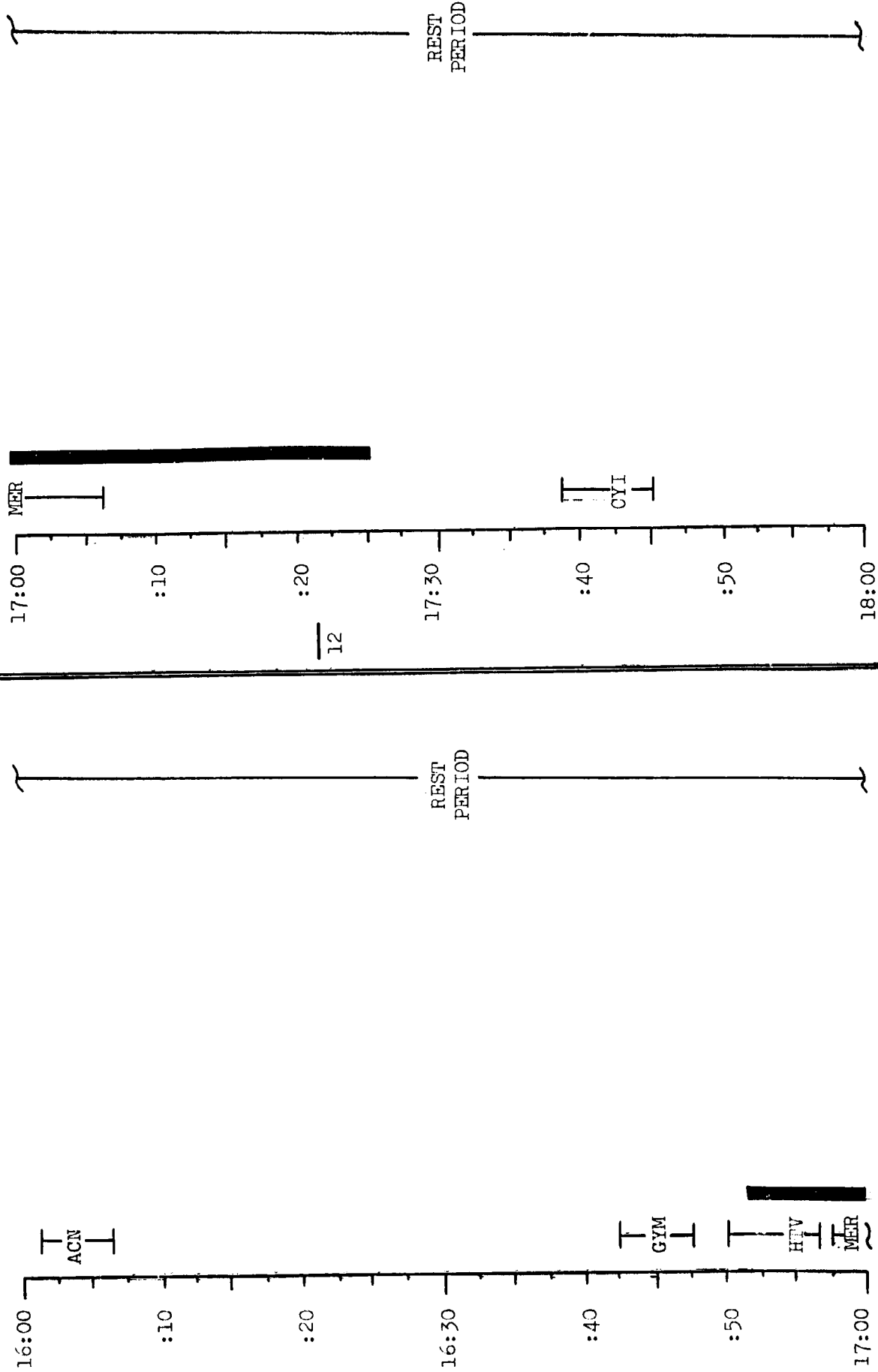

MISSION	EDITION	DATE	TIME	DAY/REV	PAGE
APOLLO 9	FINAL	FEBRUARY 3, 1969	16:00 - 18:00	1/11-12	3-11

# FLIGHT PLAN

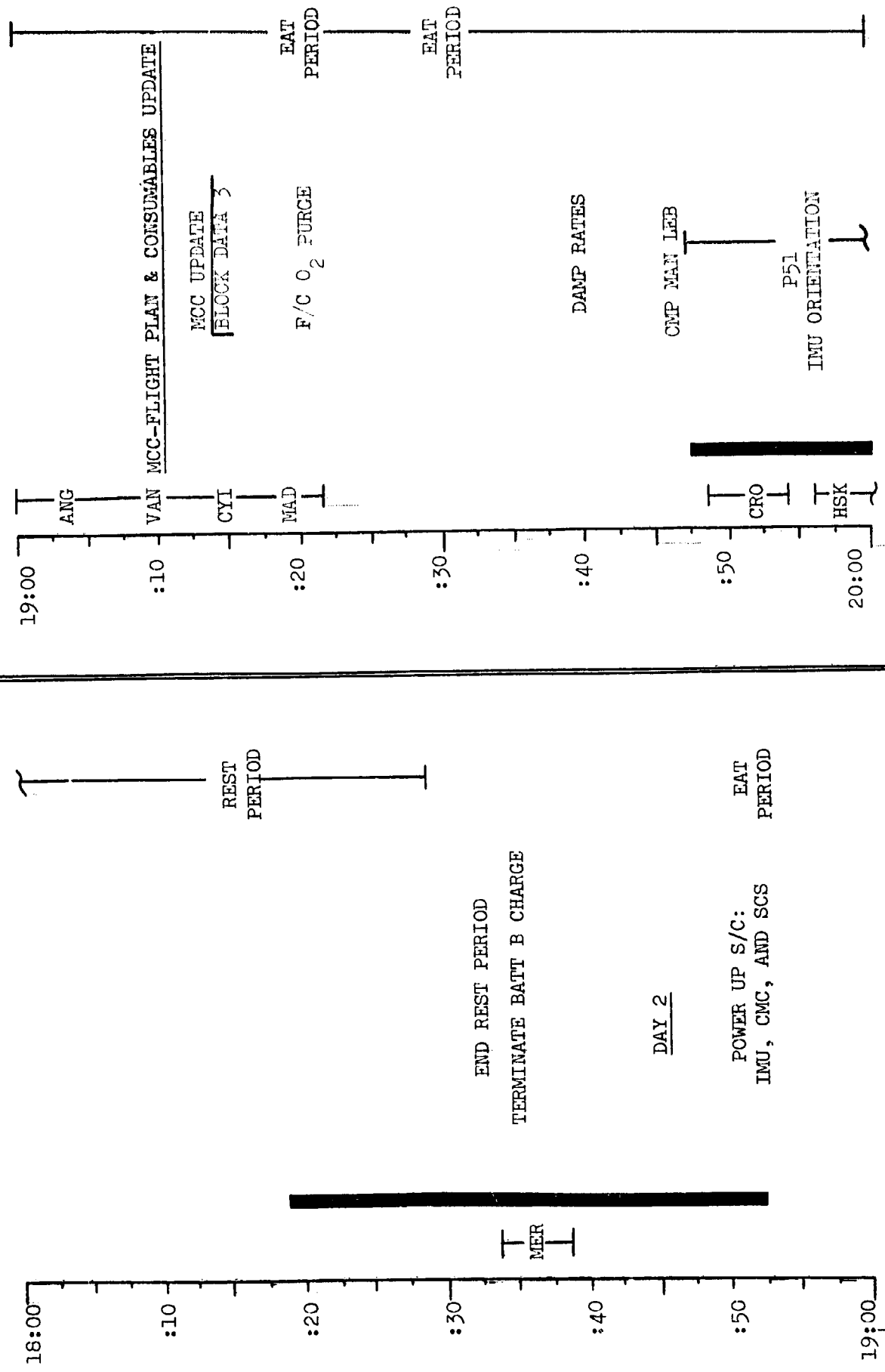

MISSION	EDITION	DATE	TIME	DAY/REV	PAGE
APOLLO 9	FINAL	FEBRUARY 3, 1969	18:00 - 20:00	1-2/12-13	3-12

# FLIGHT PLAN

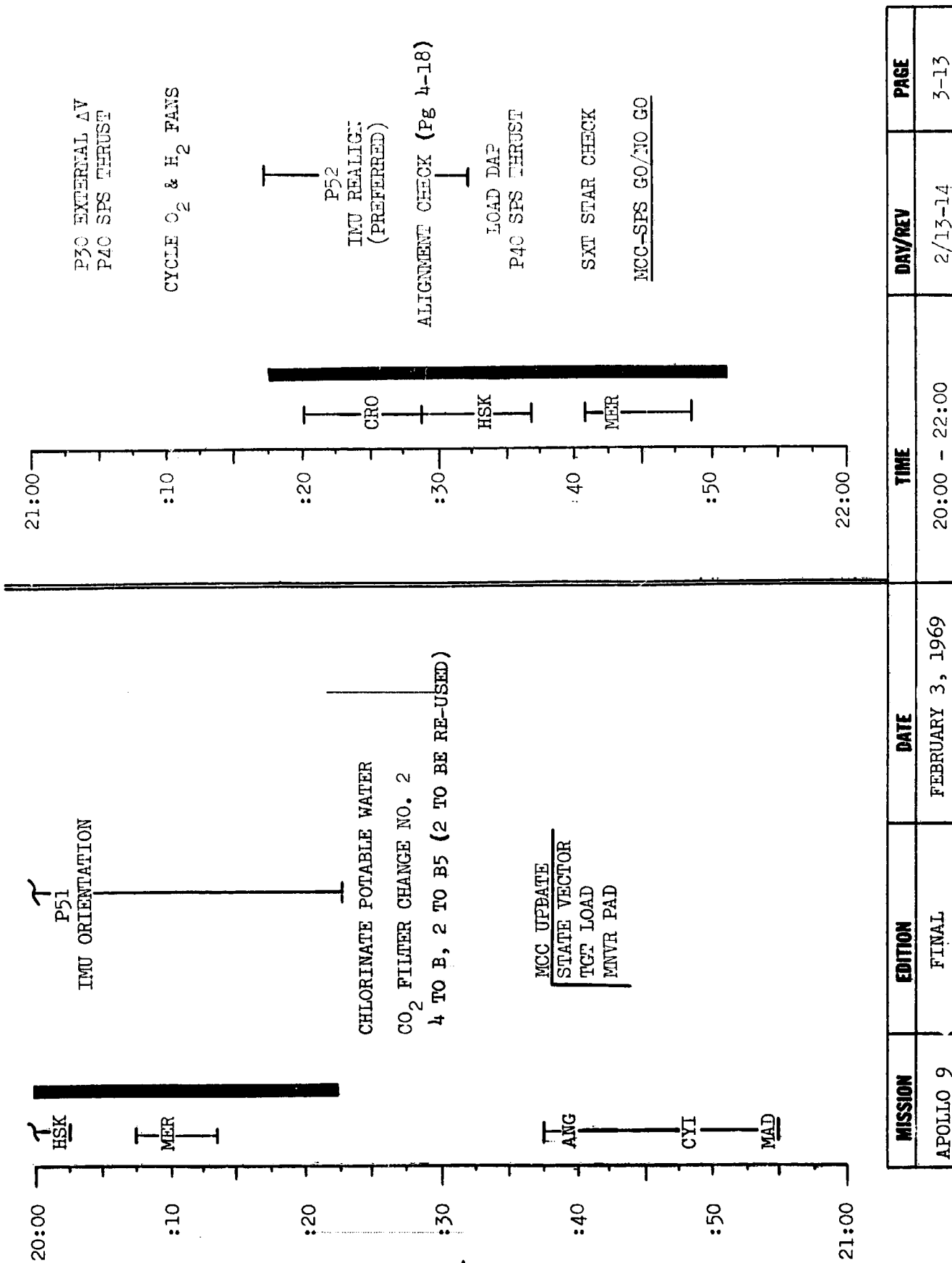

20:00      HSK      MER      ANG      CYI      MAD

:10

:20

:30

:40

:50

21:00

21:00

:10

:20

:30

:40

:50

22:00

P51  
IMU ORIENTATION

CHLORINATE POTABLE WATER  
CO<sub>2</sub> FILTER CHANGE NO. 2  
4 TO B, 2 TO B5 (2 TO BE RE-USED)

MCC UPDATE  
STATE VECTOR  
TGT LOAD  
MNVR PAD

P30 EXTERNAL ΔV  
P40 SPS THRUST

CYCLE O<sub>2</sub> & H<sub>2</sub> FANS

P52  
IMU REALIGN:  
(PREFERRED)

ALIGNMENT CHECK (Pg 4-18)

LOAD DAP  
P40 SPS THRUST

SXT STAR CHECK

MCC-SPS GO/NO GO



# FLIGHT PLAN

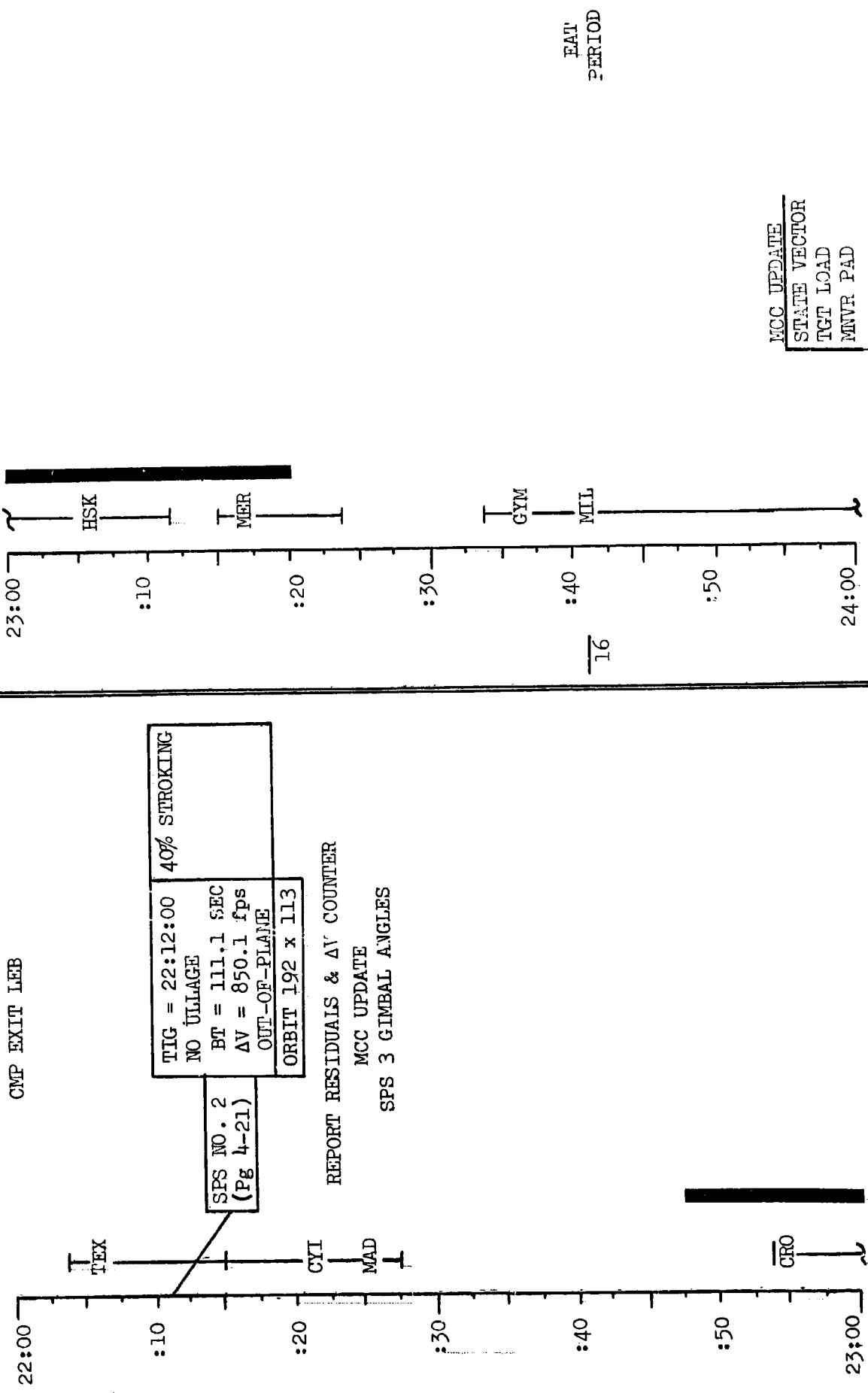

EAT  
PERIOD

MCC UPDATE  
STATE VECTOR  
TGT LOAD  
MNRV PAD

MISSION	EDITION	DATE	TIME	DAY/REV	PAGE
APOLLO 9	FINAL	FEBRUARY 3, 1969	22:00 - 24:00	2/14-16	3-14

# FLIGHT PLAN

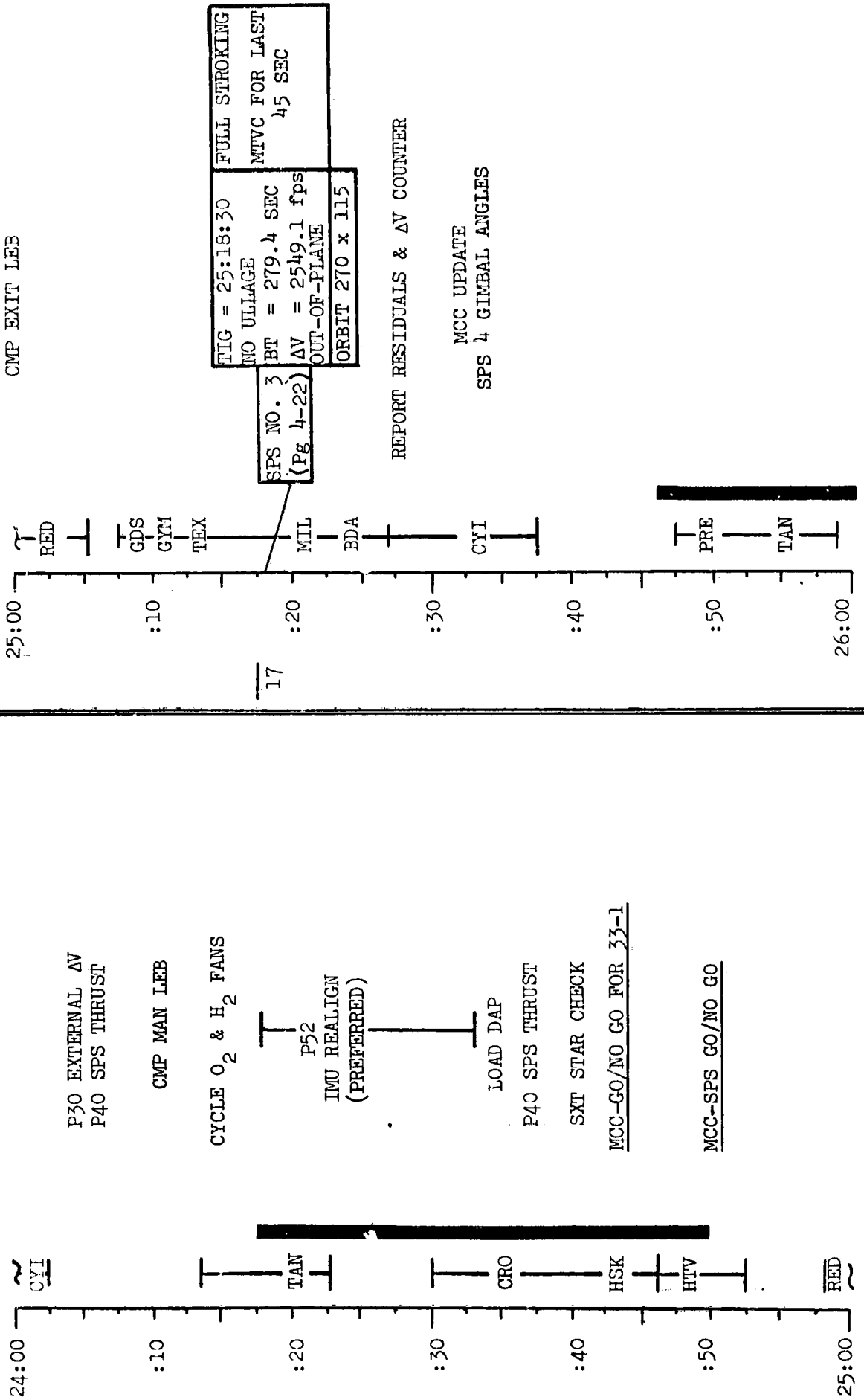

MISSION	EDITION	DATE	TIME	DAY/REV	PAGE
APOLLO 9	FINAL	FEBRUARY 3, 1969	24:00 - 26:00	2/16-17	3-15

# FLIGHT PLAN

P30 EXTERNAL ΔV  
P40 SPS THRUST

CMP MAN LEB

P52  
IMU REALIGN  
(PREFERRED)

CYCLE O<sub>2</sub> & H<sub>2</sub> FANS

LOAD DAP

P40 SPS THRUST

SXT SEAR CHECK

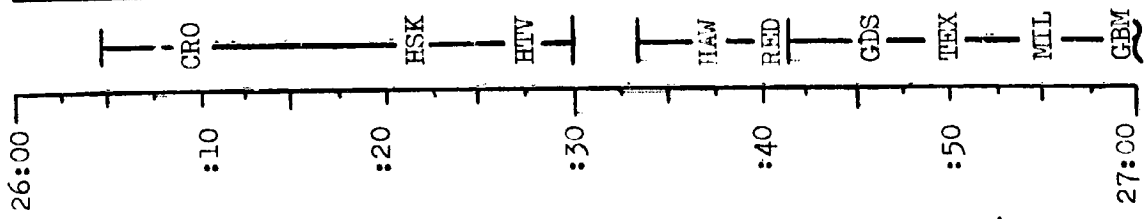
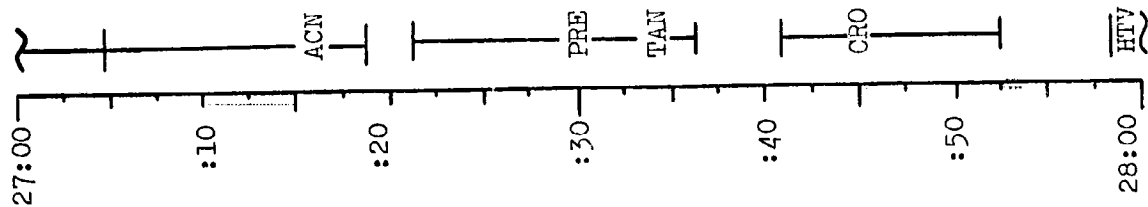

MCC UPDATE  
STATE VECTOR  
TGT LOAD  
MNVR PAD

MISSION	EDITION	DATE	TIME	DAY/REV	PAGE
APOLLO 9	FINAL	FEBRUARY 3, 1969	26:00 - 28:00	2/17-18	3-16

# FLIGHT PLAN

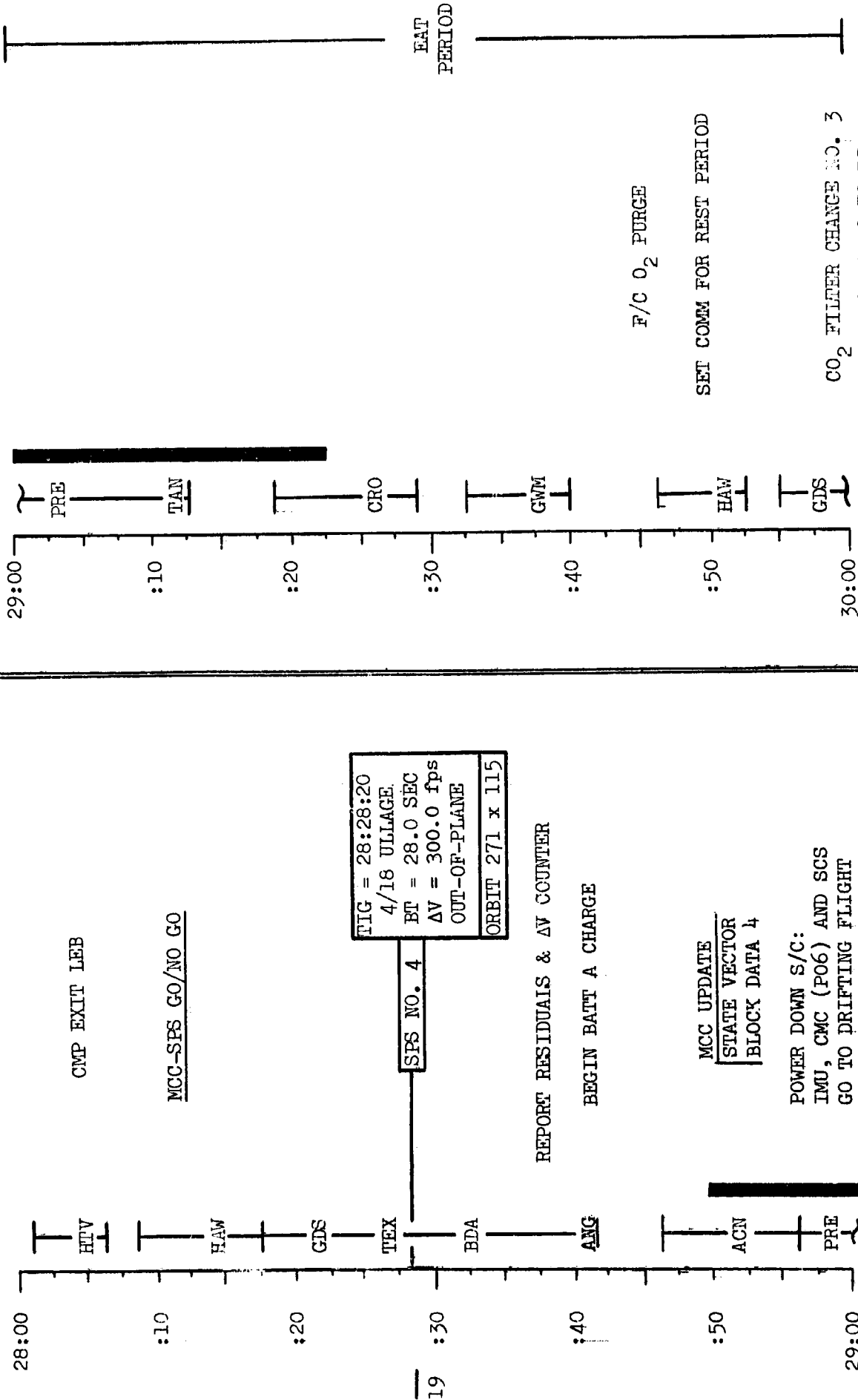

MISSION	EDITION	DATE	TIME	DAY/REV	PAGE
APOLLO 9	FINAL	FEBRUARY 3, 1969	28:00 - 30:00	2/18-19	3-17

# FLIGHT PLAN

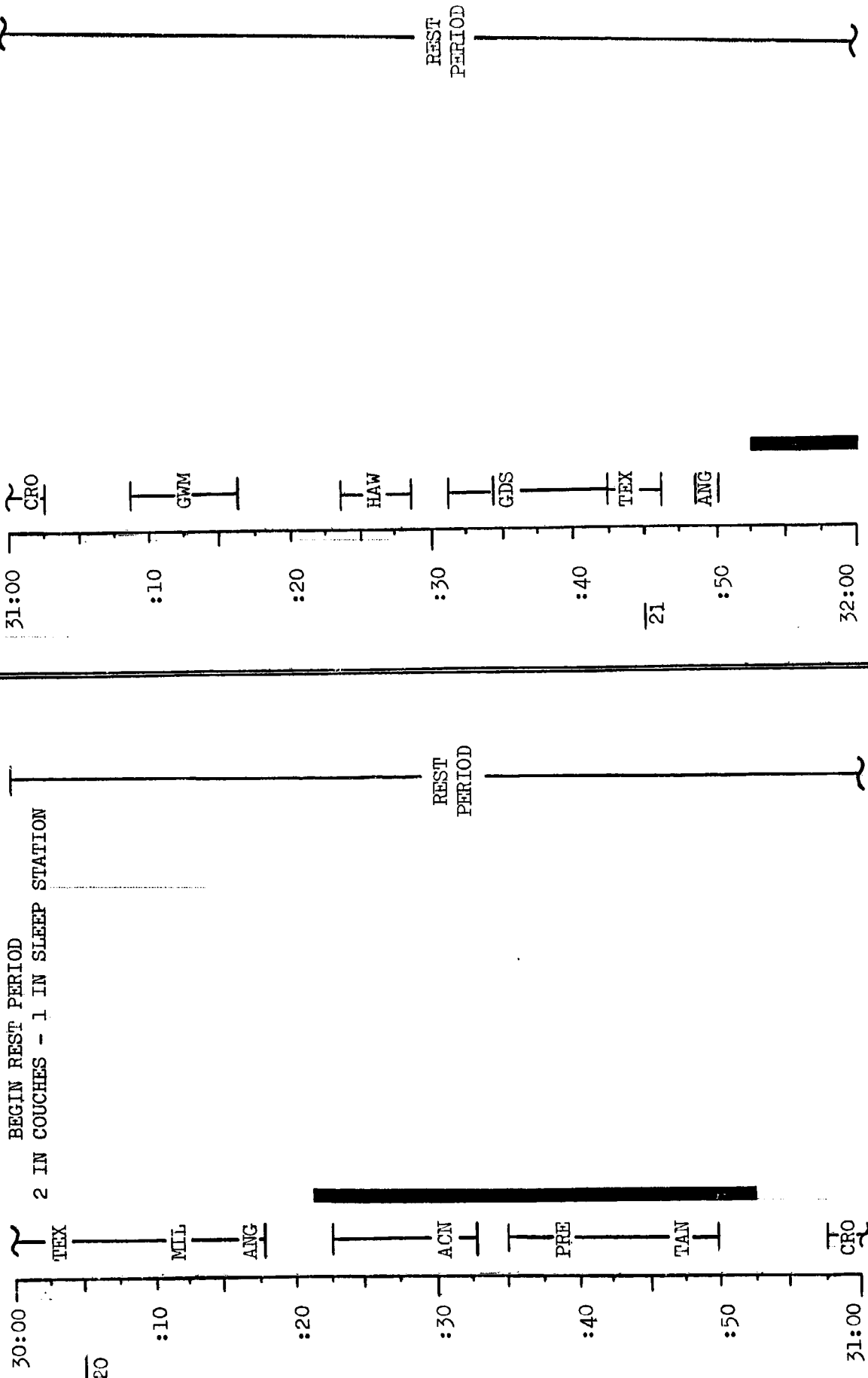

MISSION	EDITION	DATE	TIME	DAY/REV	PAGE
APOLLO 9	FINAL	FEBRUARY 3, 1969	30:00 - 32:00	2/19-21	3-18

# FLIGHT PLAN

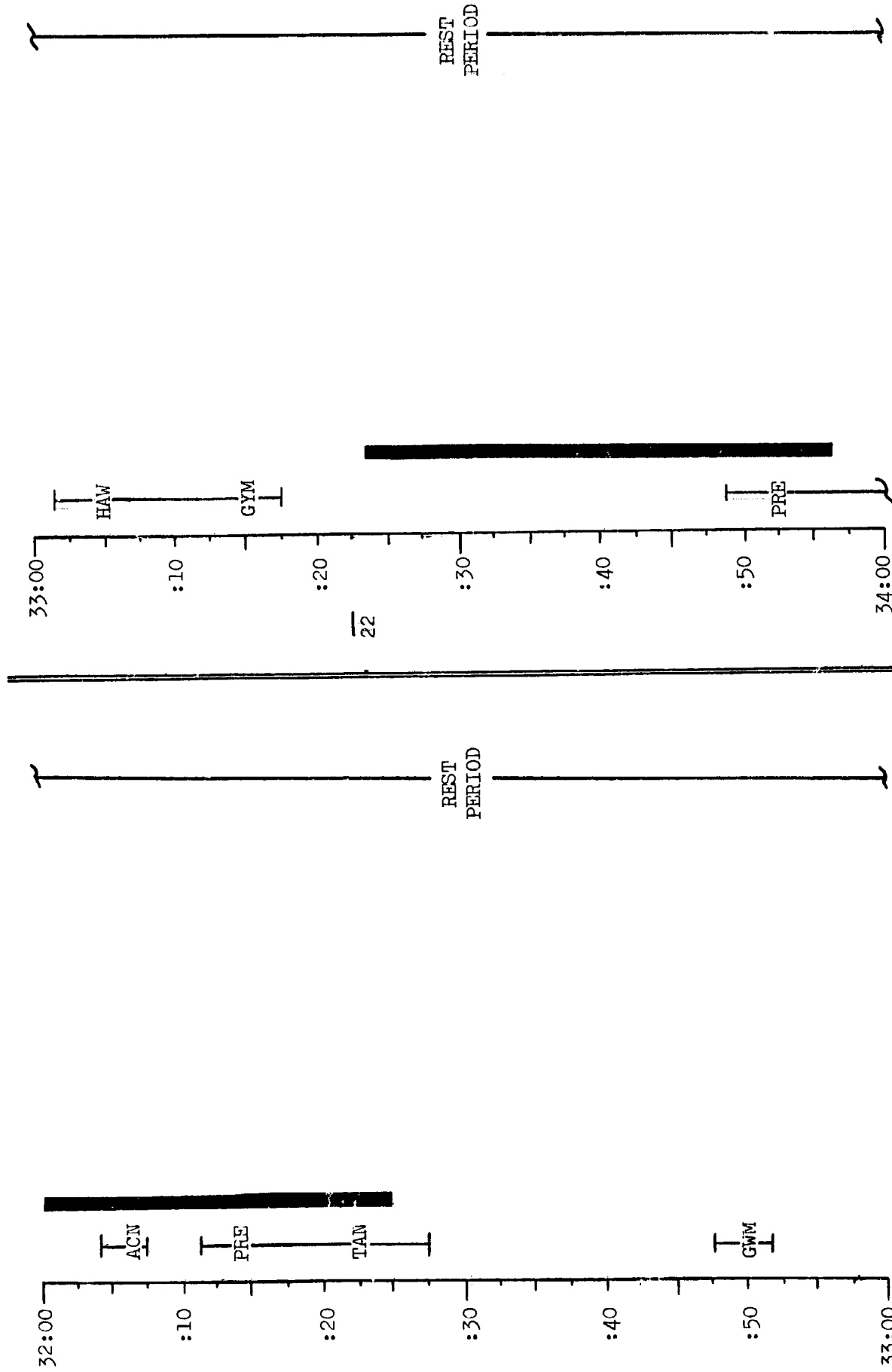

MISSION	EDITION	DATE	TIME	DAY/REV	PAGE
APOLLO 9	FINAL	FEBRUARY 3, 1969	32:00 - 34:00	2/21-22	3-19

# FLIGHT PLAN

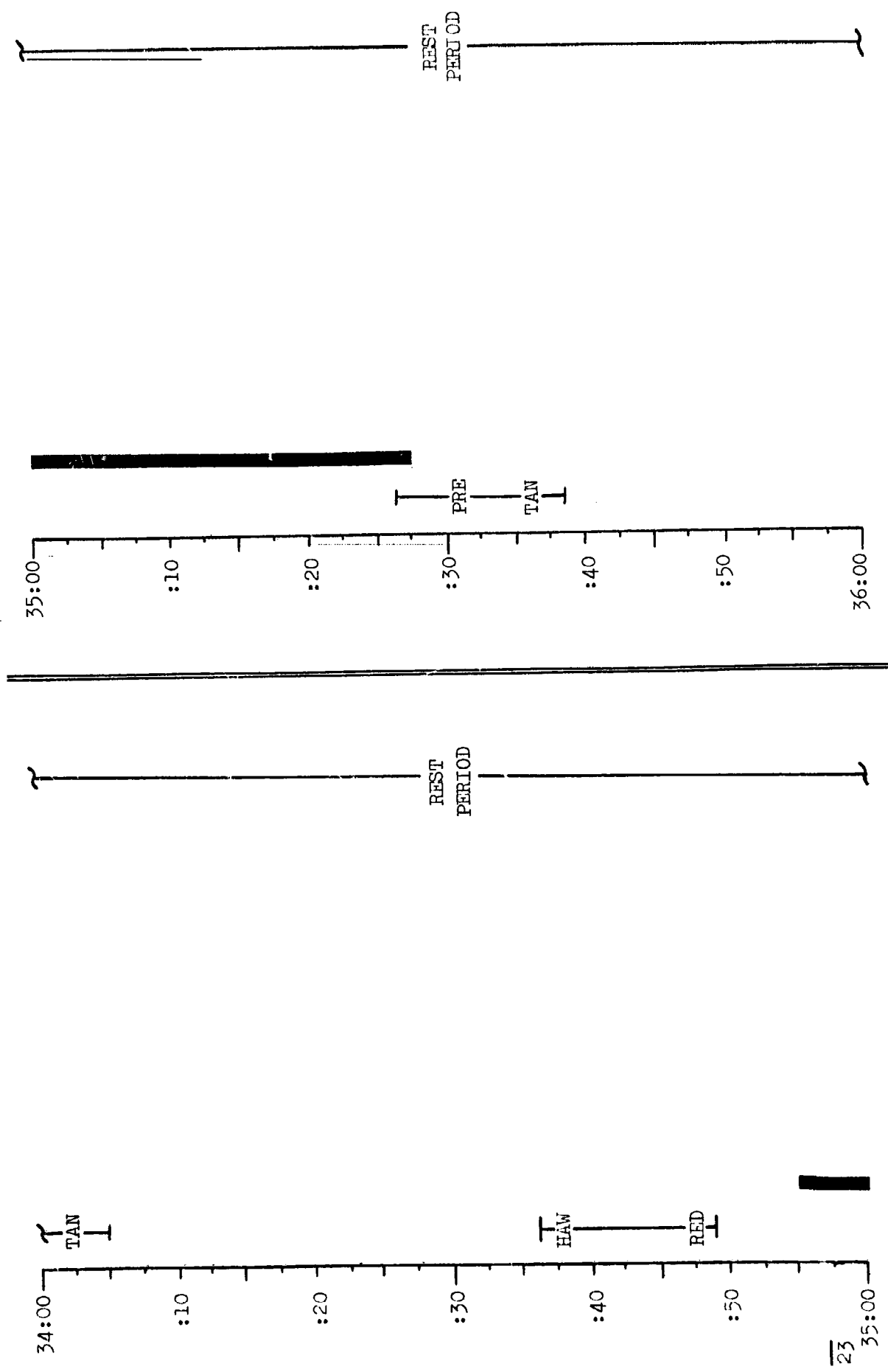

MISSION	EDITION	DATE	TIME	DAY/REV	PAGE
APOLLO 9	FINAL	FEBRUARY 3, 1969	34:00 - 36:00	2/22-23	3-20

# FLIGHT PLAN

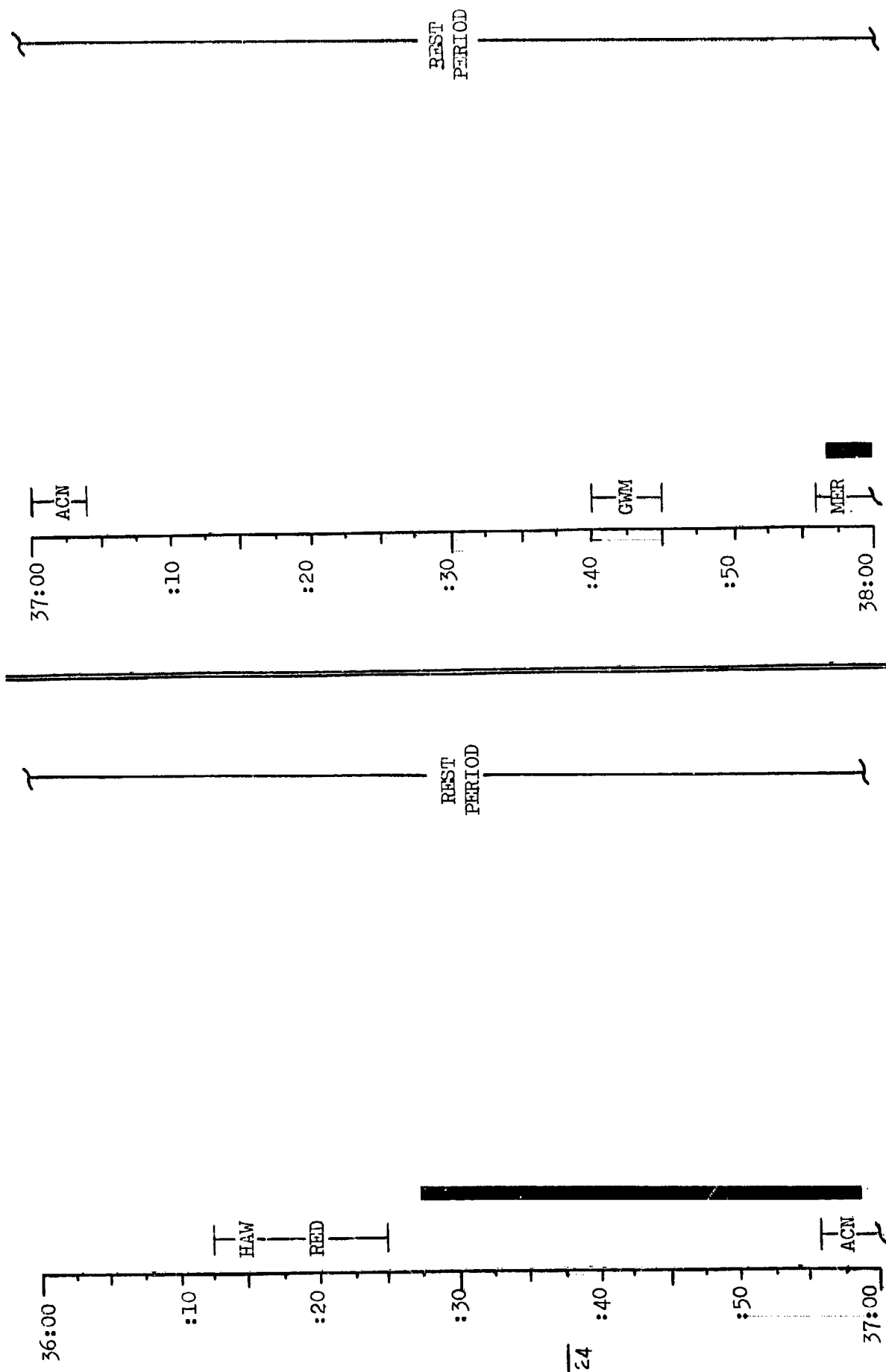

MISSION	EDITION	DATE	TIME	DAY/REV	PAGE
APOLLO 9	FINAL	FEBRUARY 3, 1969	36:00 - 38:00	2/23-24	3-21



# FLIGHT PLAN

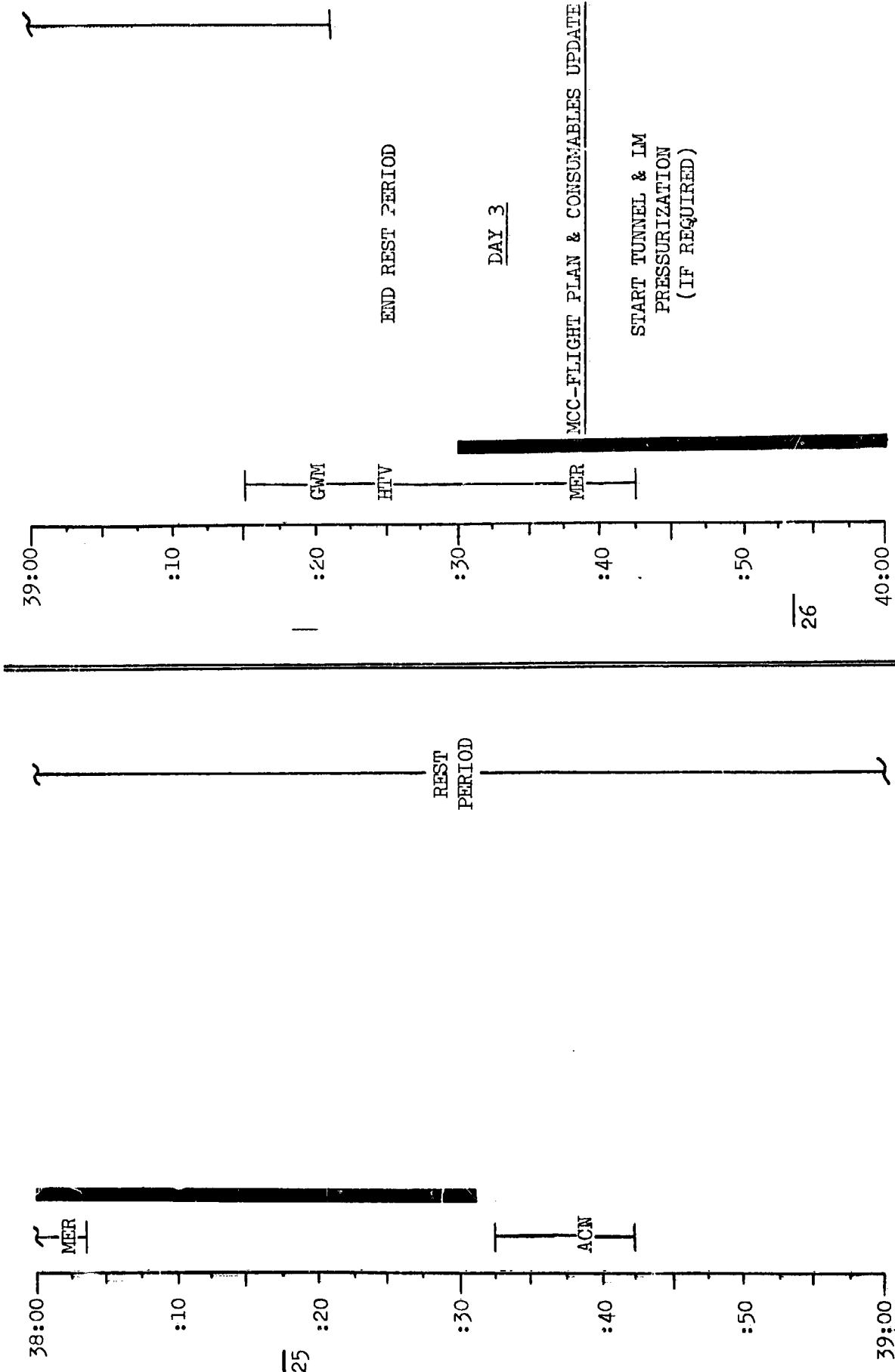

MISSION	EDITION	DATE	TIME	DAY/REV	PAGE
APOLLO 9	FINAL	FEBRUARY 3, 1969	38:00 - 40:00	2-3/24-26	3-22

# FLIGHT PLAN

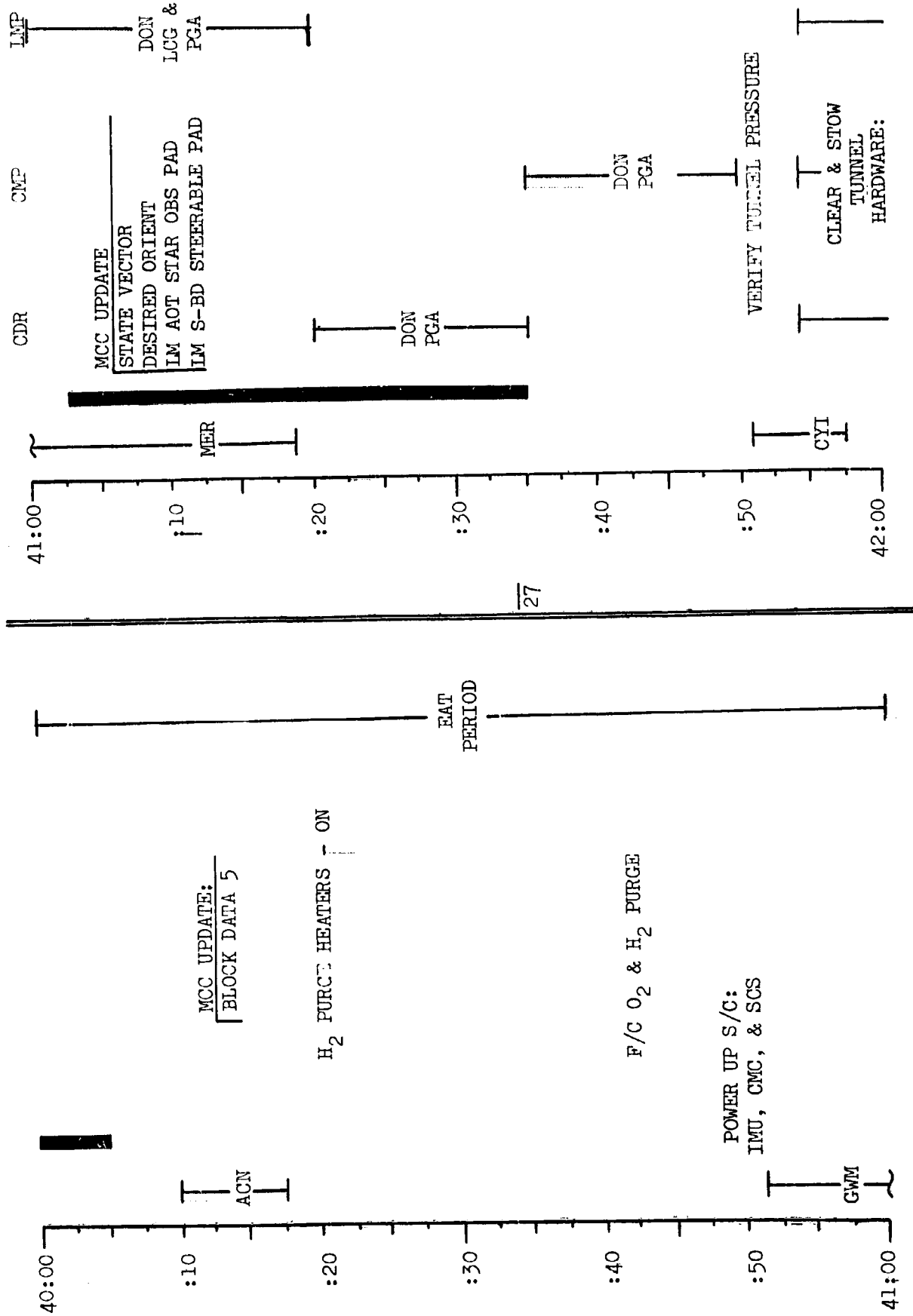

MISSION	EDITION	DATE	TIME	DAY/REV	PAGE
APOLLO 9	FINAL	FEBRUARY 3, 1969	40:00 - 42:00	3/26-27	3-23

# FLIGHT PLAN

CDR LMP IM

CSM

CDR

LMP

42:00

:10

:20

:30

:40

:50

43:00

- (1) HATCH
- (2) PROBE
- (3) DROGUE
- (Pg 4-24)

AID  
CMP

IVT TO LM

OPEN LM HATCH

LMP IVT TO LM

ENTRY STATUS CHECK

DAMP RATES

TRANSFER LM TO  
LM POWER

P51  
IMU ORIENTATION  
DETERMINATION

P52  
IMU REALIGN  
(PREFERRED)

LM VHF B & A SIMPLEX CHECKS

- EPS ACT. & C/O,  
TRANSFER TO LM PWR (Pg 4-25)
- ACTIVATE S-BAND FOR IM, DFI VHF B-ON  
GLYCOL PUMP ACT
- CAUTION/WARNING CHECKOUT
- CIRCUIT BREAKER ACT.,  
OPEN PRIM EVAP FLOW,  
& TALKBACK VERIFICATION
- ECS ACTIVATION  
& CHECKOUT (Pg 4-26)
- SUIT FAN/H<sub>2</sub>O SEPARATOR CHECK
- VHF ACT., B & A SIMPLEX CHECKS

HSK

HTV

MER

DFI\*

LBR

RECORD

43:00

\*DFI PWR SW-ON

MISSION	EDITION	DATE	TIME	DAY/REV	PAGE
APOLLO 9	FINAL	FEBRUARY 3, 1969	42:00 - 43:00	3/27	3-24

# FLIGHT PLAN

CSM

LM

CDR VHF A & B  
SIMPLEX CHECKS

CDR VHF ACT, B & A  
SIMPLEX CHECKS

CDR

LBR RECORD

43:00

:10

:20

:30

:40

:50

44:00

LBR RECORD

43:00

:10

:20

:30

:40

:50

44:00

IVT TO LM

IMP CONNECT TO LM ECS

REPORT TORQUE TIME

CDR TRANSFER  
CONNECT TO LM ECS  
CHECK COMM

INSTALL TUNNEL HARDWARE:

- (1) DROGUE
- (2) PROBE
- (3) HATCH
- (pg. 4-27)

DROGUE & PROBE INSTALLATION, OPS CHECK  
& LM OVHD HATCH CLOSING

LM/CM AP VLV - LM/CM TUNNEL

(pg. 4-27)

DOFF HELMETS & GLOVES  
CONFIGURE FOR EVT  
(1) REMOVE CENTER COUCH  
(2) PREPARE UNBILICALS

INSTALL WINDOW SHADES

GLYCOL PUMP CHECK

V49: R = 87.0°, P = 5.2°, Y = 301.8°

ARS/PGA PRESSURE INTEGRITY CHECK

MNVR FOR LM  
ACT STAR OBSERVATION

REGULATOR CHECK

DISABLE SM RCS THRUSTER B3  
(UNTIL UNDOCKING)

ASCENT BATTERY ACT & CHECKOUT

UNSTOW RR  
DESIGNATE RR

INSTALL DOCKING TARGET  
IN RH RNDZ WINDOW

DAYLIGHT ACT STAR VISIBILITY  
CHECK (pg. 4-28)  
(SIRIUS)

MISSION	EDITION	DATE	TIME	DAY/REV	PAGE
APOLLO 9	FINAL	FEBRUARY 3, 1969	43:00 - 44:00	3/27-28	3-25

# FLIGHT PLAN

CSM  
CMP

CO<sub>2</sub> FILTER CHANGE NO. 4  
6 TO B, 4 TO B5

S-Band CONFERENCE  
(MSFW RELAY) (pg 4-31)

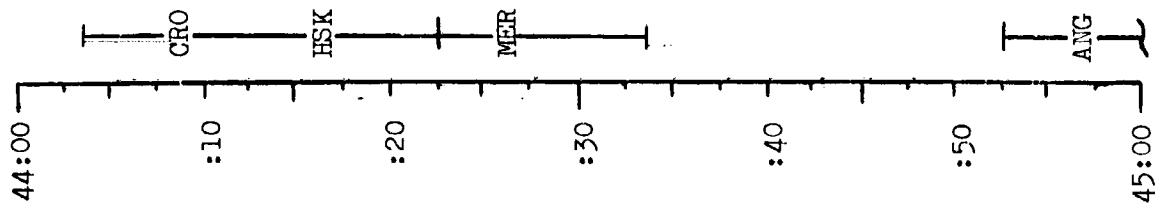

CDR

IM

LMP

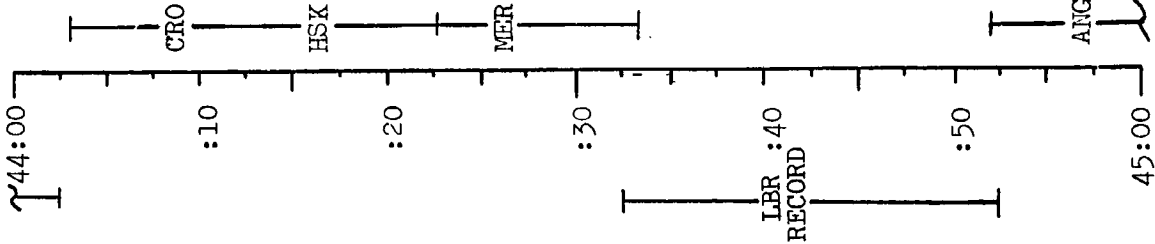

S-BAND STERABLE.  
ANTENNA CHECK  
(pg. 4 - 30)

S-BAND BACKUP  
VOICE & KEYING CHECK  
(pg. 4 - 31)

S-BAND CONFERENCE  
(MSFN RELAY)  
(pg. 4 - 34)

EXT. LTG CHECKS  
& COAS LTG

SECONDARY S-BAND  
CHECK (pg 4 - 31)

MISSION	EDITION	DATE	TIME	DAY/REV	PAGE
APOLLO 9	FINAL	FEBRUARY 3, 1969	44:00 - 45:00	3/23-29	3-26

# FLIGHT PLAN

CSM  
CMP

CDR

IA

LMP

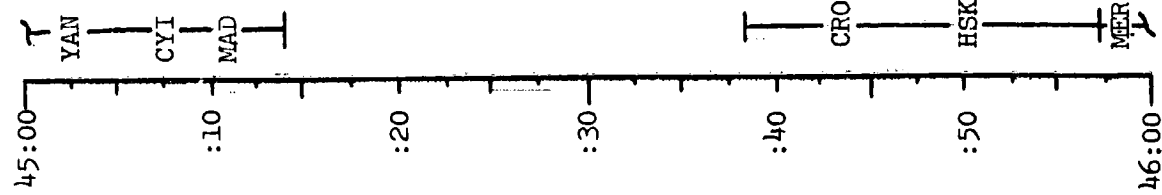
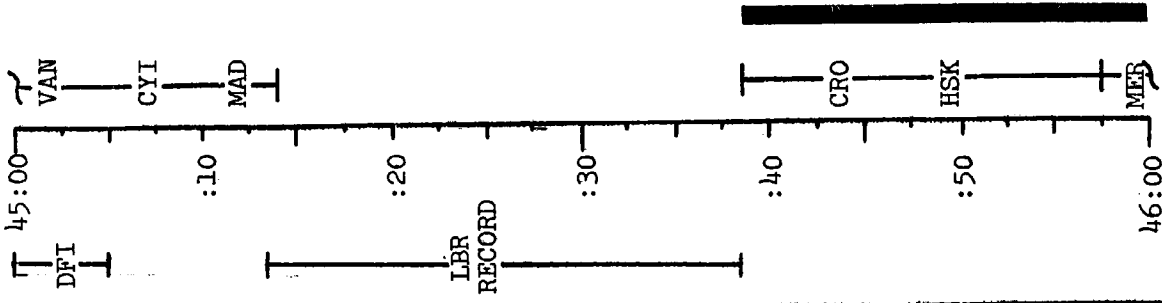

LANDING GEAR DEPLOY (Pg 4-33)

PLSS PREP:

- (1) INSTALL ISA
- (2) UNSTOW TV
- (3) UNSTOW PLSS BATT
- (4) BLEED DOWN PLSS HOSES
- (5) UNSTOW OPS
- (6) VERIFY LIQH CARTRIDGE
- (7) ATTACH OPS TO PLSS
- (8) INSTILL PLSS BAT IN PLSS
- (9) UNSTOW RCU
- (10) CONNECT RCU TO PLSS
- (11) PREP FOOD

PLSS COMM CHECK WITH LM  
PLSS POS 1 & 4

CSM 1-WAY RELAY  
WITH LM SIMULATING PLSS  
(PLSS IN POS 4)

LM 1-WAY RELAY  
USING PLSS SIMULTANEOUS  
WITH CSM 1-WAY RELAY

CSM 1-WAY RELAY  
WITH LM SIMULATING PLSS

CSM 1-WAY RELAY  
SIMULTANEOUS WITH  
LM 1-WAY RELAY

MISSION	EDITION	DATE	TIME	DAY/REV	PAGE
APOLLO 9	FINAL	FEBRUARY 3, 1969	45:00 - 46:00	3/29	3-27

# FLIGHT PLAN

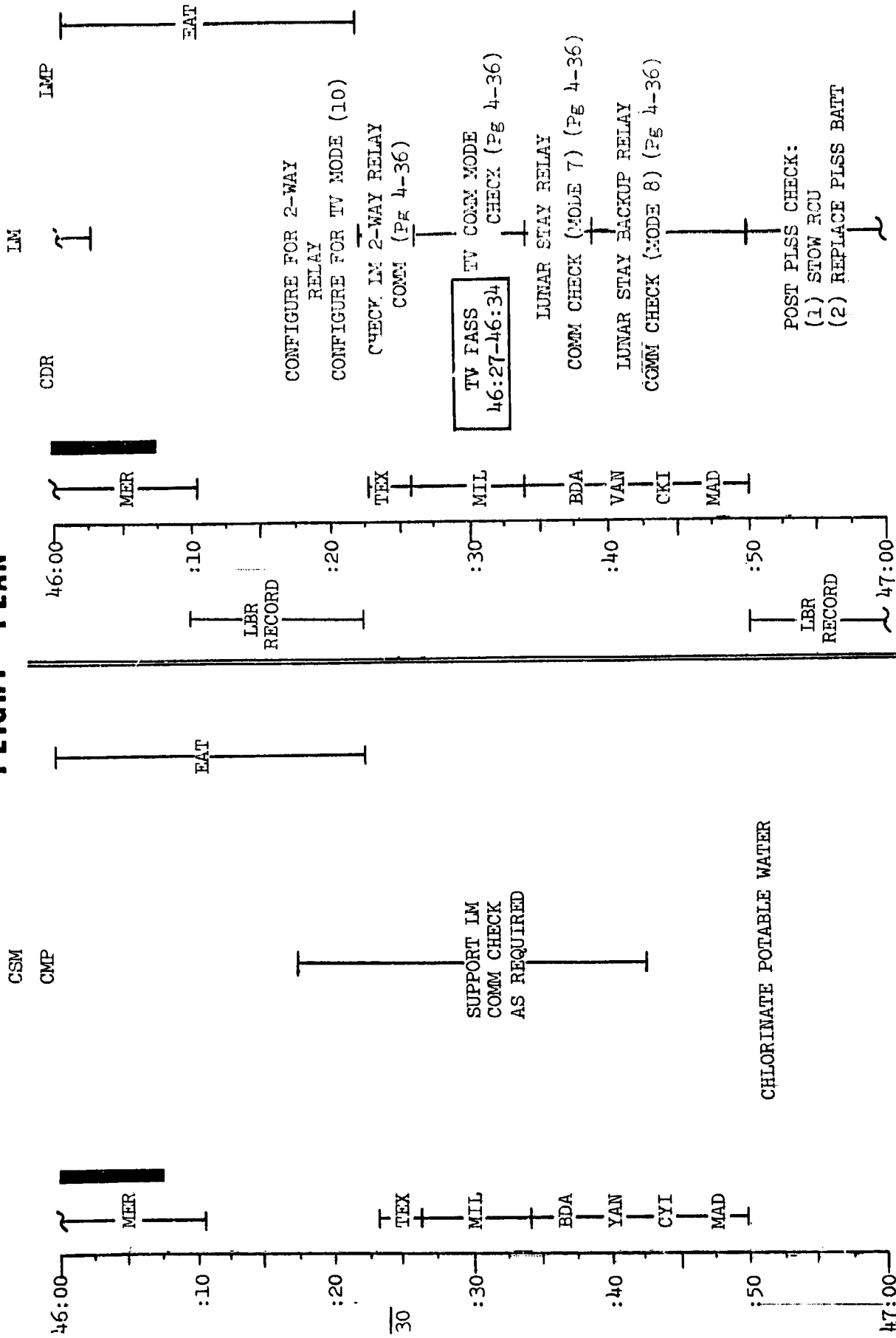

MISSION	EDITION	DATE	TIME	PAGE/REV	PAGE
APOLLO 9	FINAL	FEB 3, 1969	46:00 - 47:00	3/29-30	3-28

CSM  
CMP

# FLIGHT PLAN

AM

CDR

LFP

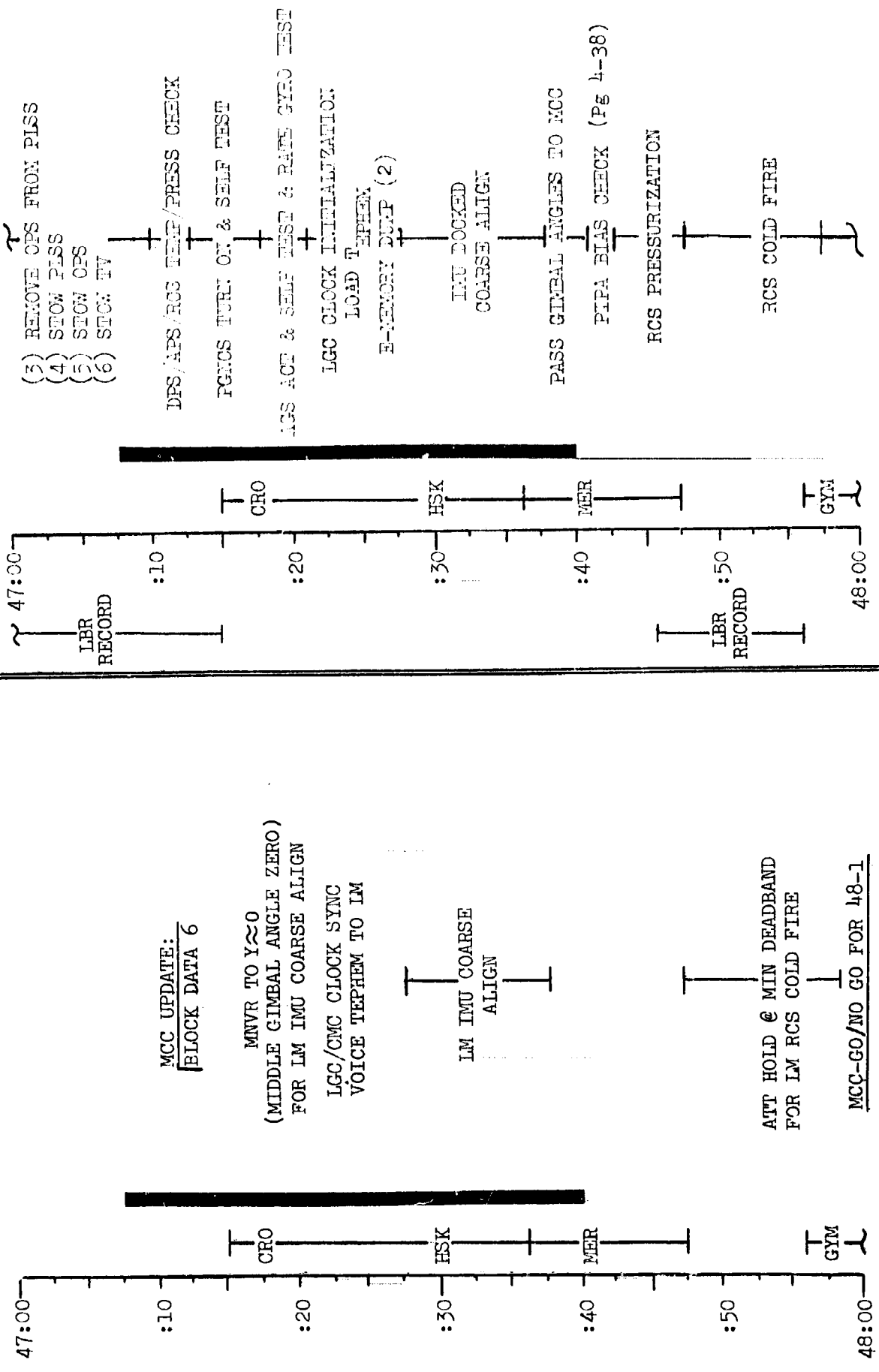

MISSION	EDITION	DATE	TIME	DAY/REV	PAGE
APOLLO 9	FINAL	FEBRUARY 3, 1969	47:00 - 48:00	3/30	3-29



# FLIGHT PLAN

CDR

LM

LMC

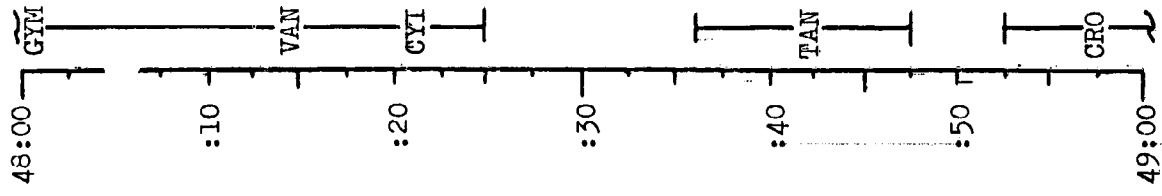

MCC UPDATE:  
LM STATE VECTOR  
CSM STATE VECTOR  
MNVR PAD FOR  
LM DOCKED DPS

CMC-FREE  
LM RCS HOT FIRE  
CMC-HOLD

V49:R=322.5°, P=157.5°, Y=337.5°  
MNVR TO AGS CAL  
ATTITUDE

CYCLE O<sub>2</sub> & H<sub>2</sub> FANS

P52  
IMU REALIGN  
(REFSMAT)

REPORT TORQUING ANGLES & TIME

READ GIMBAL ANGLES TO LM

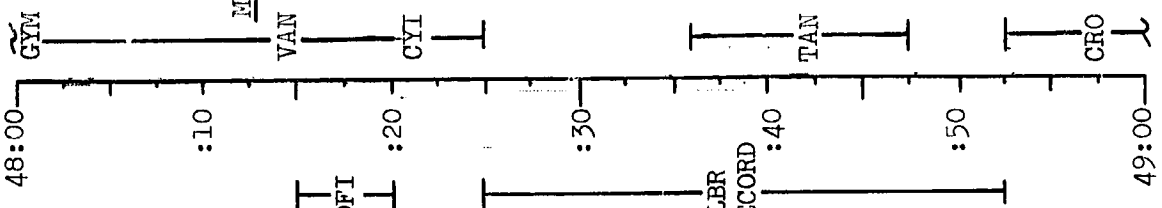

31

DAP SET, GIMBAL  
DRIVE CHECK & THROTTLE TEST  
RCS HOT FIRE  
LM STATE VECTOR GYRO TORQUING ANGLES  
REFSMAT  
MCC UPDATE:  
MNVR PAD FOR DOCKED DPS  
IMU FINE ALIGN TORQUING

LR SELF TEST  
(PF 4-39)

RR SELF TEST

AGS INITIALIZATION (Pg 4-40)

AGS CALIBRATION  
(Pg 4-41)

REPORT AGS CAL RESULTS

DPS PRESSURIZATION

READ GIMBAL ANGLES & VOICE  
TO MCC FOR IMU REALIGNMENT

MISSION	EDITION	DATE	TIME	DAY/REV	PAGE
APOLLO 9	FINAL	FEBRUARY 3, 1969	48:00 - 49:00	3/30-31	3-30

CSM  
CMP

# FLIGHT PLAN

CDR

LM

LMP

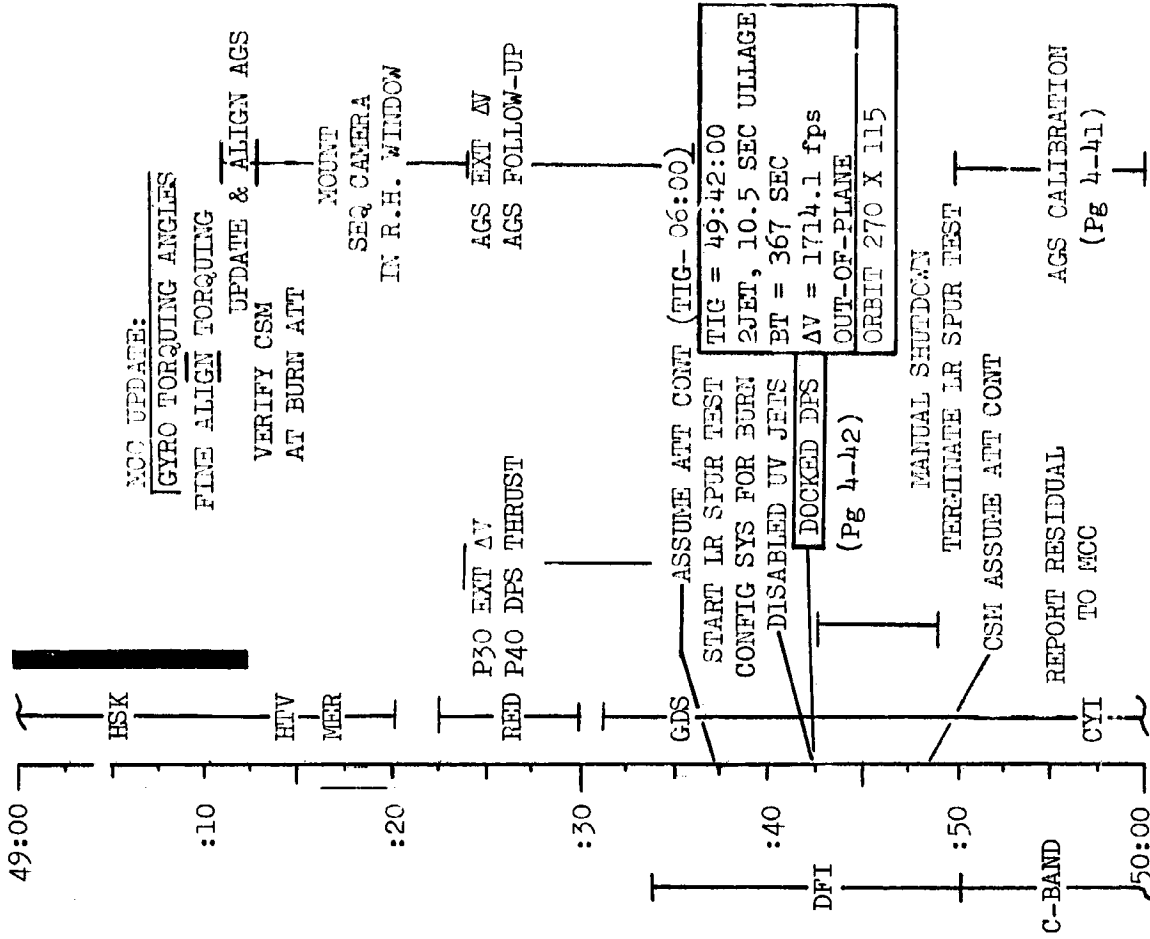
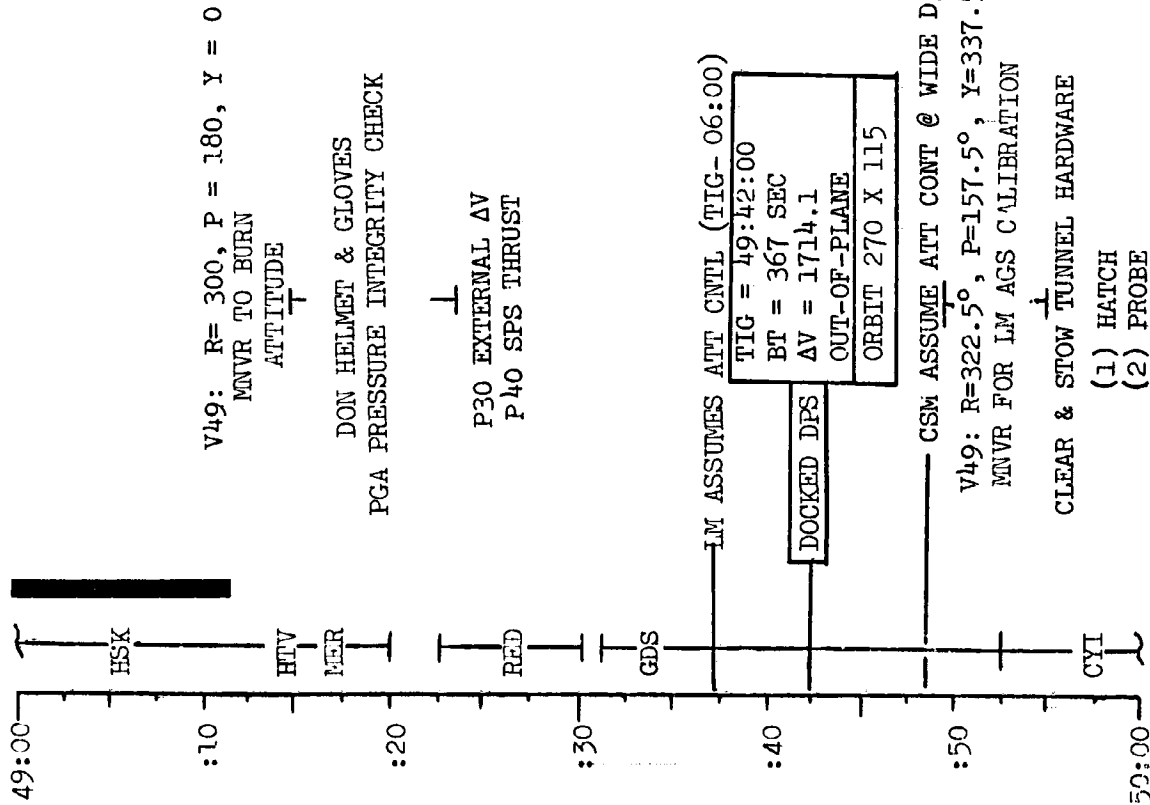

TIG = 49:42:00  
2JET, 10.5 SEC ULLAGE  
BT = 367 SEC  
AV = 1714.1 fps  
OUT-OF-PLANE  
ORBIT 270 X 115

MANUAL SHUTDOWN  
TERMINATE LR SPUR TEST  
AGS CALIBRATION  
(Pg 4-41)

MISSION	EDITION	DATE	TIME	DAY/REV	PAGE
APOLLO 9	FINAL	FEBRUARY 3, 1969	49:00 TO 50:00	3/31-32	3-31

# FLIGHT PLAN

CDR CSM  
CMP

CDR IM  
LMP

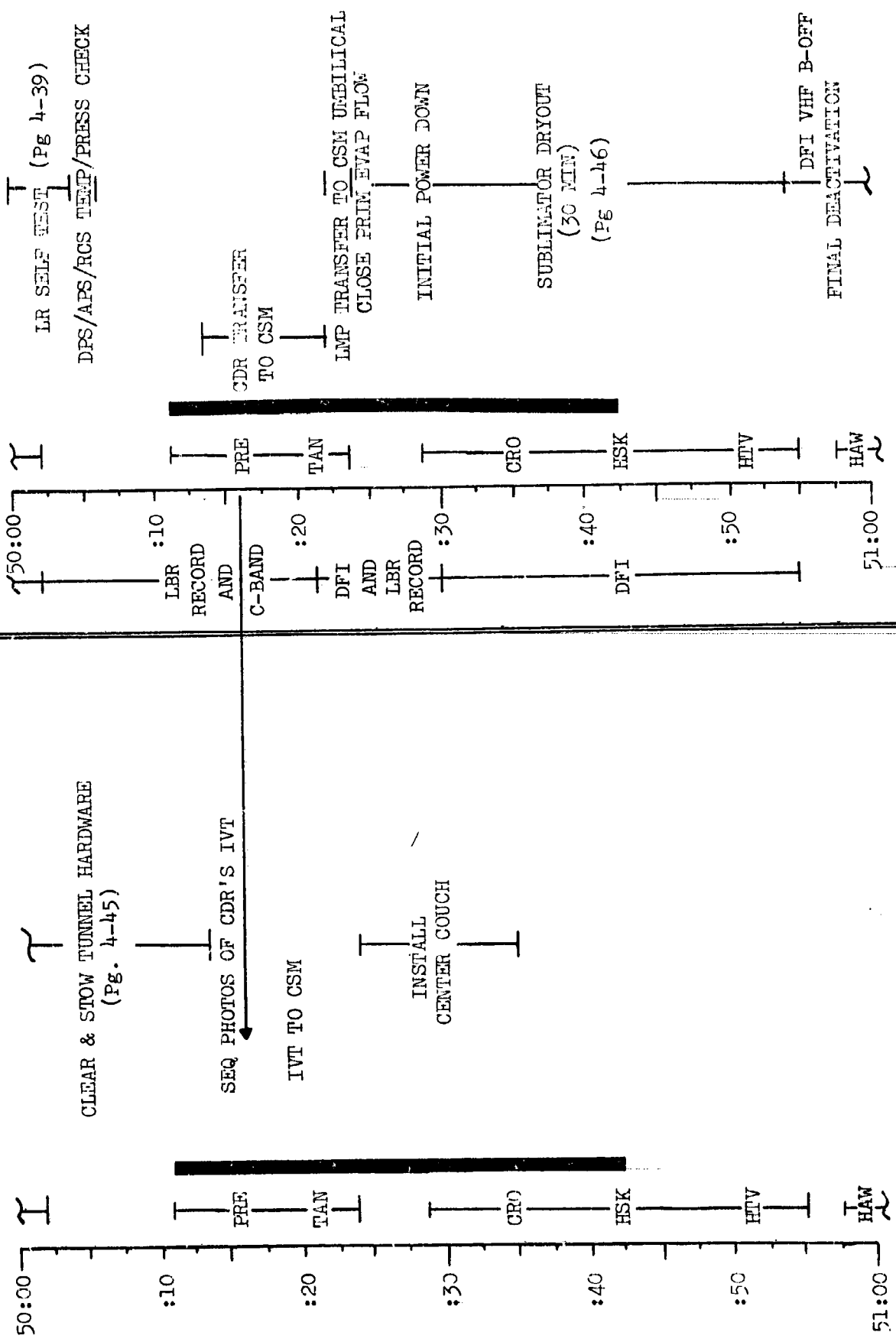

MISSION	EDITION	DATE	TIME	DAY/REV	PAGE
APOLLO 9	FINAL	FEBRUARY 3, 1969	50:00 - 51:00	3/32	3-32

# FLIGHT PLAN

**CSM**

CMP

CDR

LMP

TRANSFER LM TO CSM POWER

51:00

HAW

RED

:10

GDS

:20

INSTALL FUNNEL HARDWARE:

- (1) DROGUE
- (2) PROBE
- (3) HATCH

:30

VAN

IM/CM AP VLV - IM

:40

ACN

:50

PRE

F/C O<sub>2</sub> PURGE

52:00

TAN

IVT TO CSM

**LM**

LMP

TRANSFER TO CSM POWER

HAW

RED

:10

IVT TO CSM

GDS

:20

CLOSE LM OVHD HATCH

:30

VAN

:40

ACN

:50

PRE

52:00

TAN

33

33

MISSION	EDITION	DATE	TIME	DAY/REV	PAGE
APOLLO 9	FINAL	FEBRUARY 3, 1969	51:00 - 52:00	3/32-33	3-33

# FLIGHT PLAN

CDR

OMP

LMP

P30 EXTERNAL AV  
P40 SPS THRUST

P52  
IMU REALIGN  
(PREFERRED)

LOAD DAP  
P40 SPS THRUST

SXT STAR CHECK

CYCLE O<sub>2</sub> & H<sub>2</sub> FANS

MCC-SPS GO/NO GO

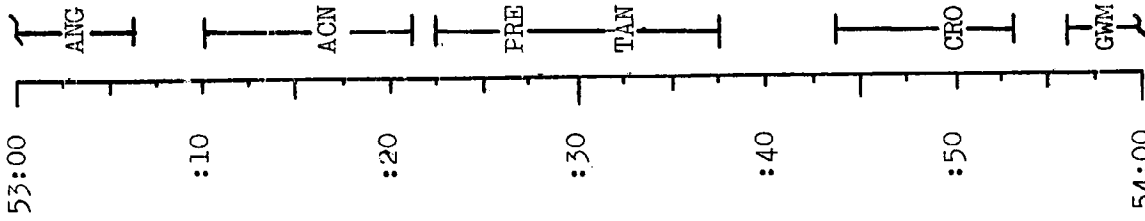

CDR

OMP

LMP

MCC UPDATE :

STATE VECTOR  
TGT LOAD  
MNRV PAD

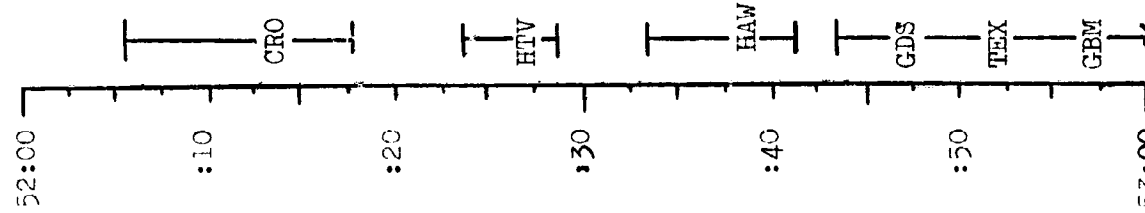

MISSION	EDITION	DATE	TIME	DAY/REV	PAGE
APOLLO 9	FINAL	FEBRUARY 3, 1969	52:00 - 54:00	3/33-34	3-34

# FLIGHT PLAN

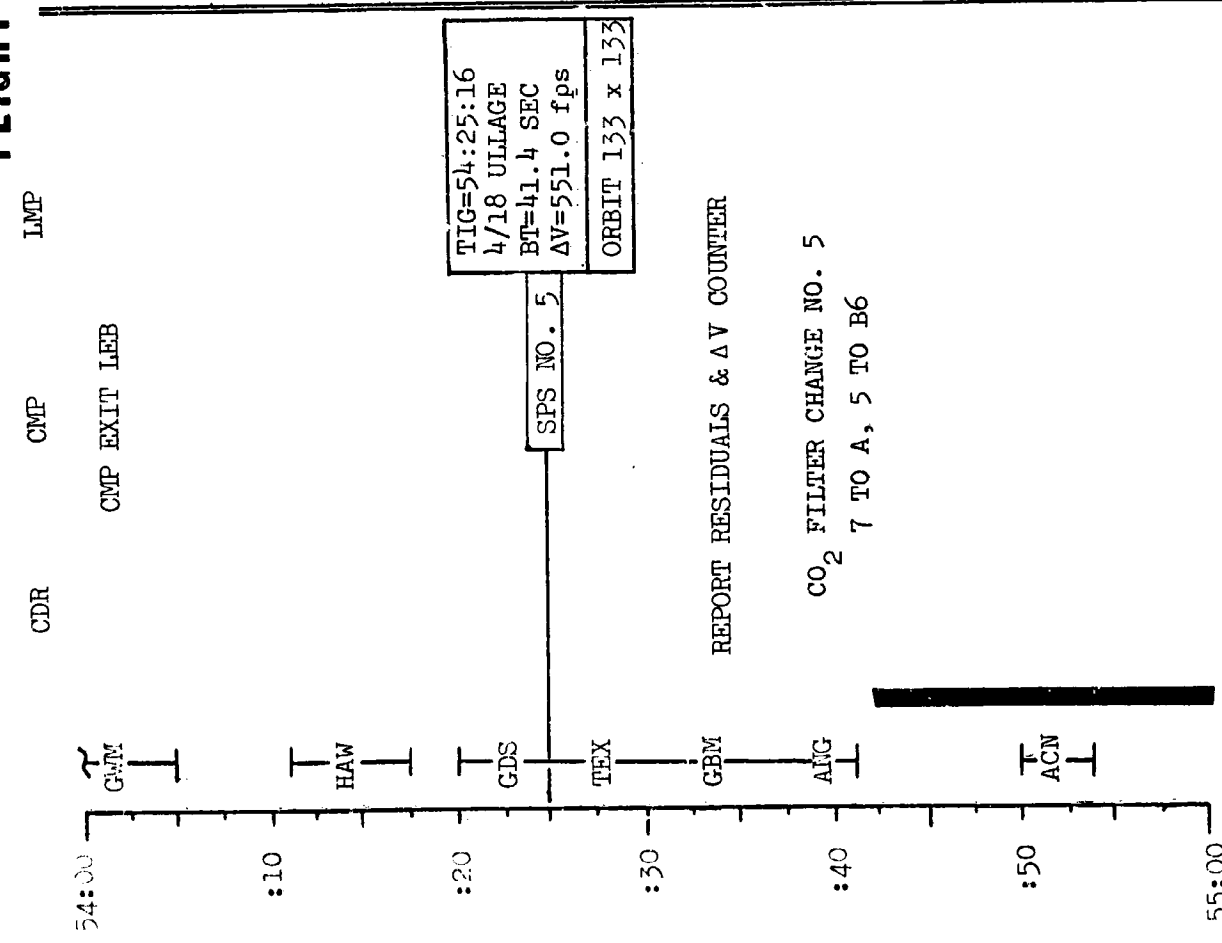
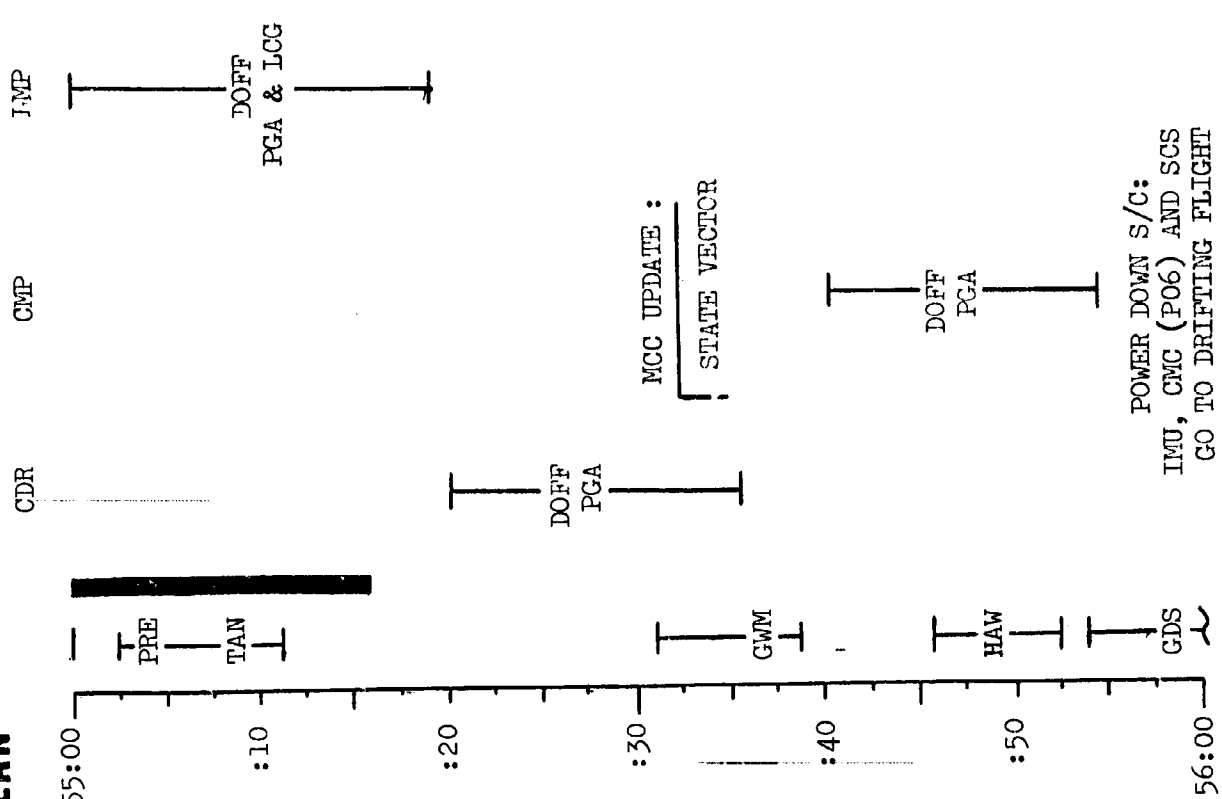

TIG=54:25:16  
 4/18 ULLAGE  
 BT=41.4 SEC  
 ΔV=551.0 fps  
 ORBIT 133 x 133

SPS NO. 5

REPORT RESIDUALS & ΔV COUNTER

CO<sub>2</sub> FILTER CHANGE NO. 5  
 7 TO A, 5 TO B6

POWER DOWN S/C:  
 IMU, CMC (P06) AND SGS  
 GO TO DRIFTING FLIGHT

MISSION	EDITION	DATE	TIME	PAY/REV	PAGE
APOLLO 9	FINAL	FEBRUARY 3, 1969	56:00 - 58:00	3/34-35	3-35

# FLIGHT PLAN

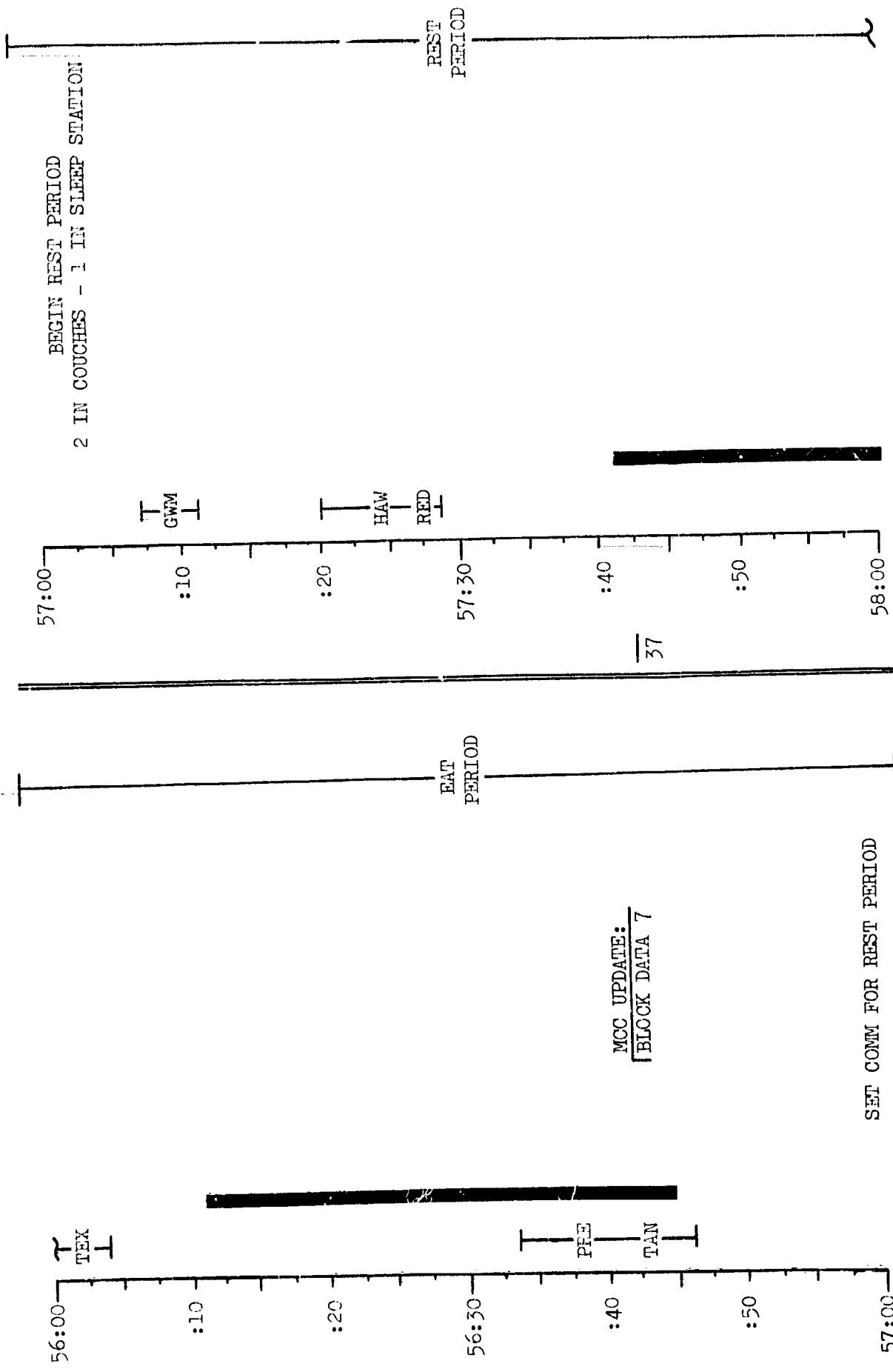

MISSION	EDITION	DATE	TIME	DAY/REV	PAGE
APOLLO 9	FINAL	FEBRUARY 3, 1969	56:00 - 58:00	3/35-37	3-36

# FLIGH. PLAN

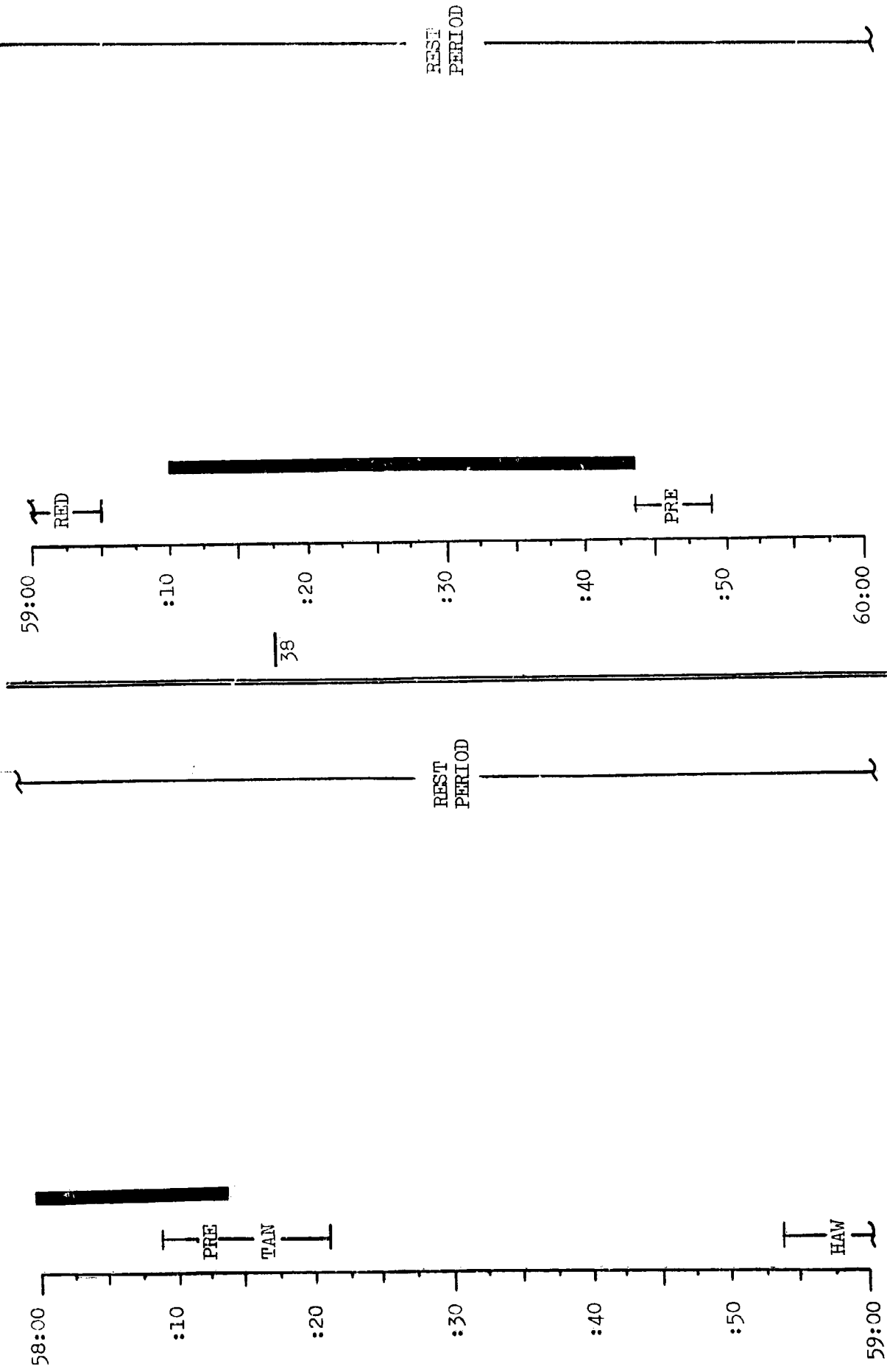

MISSION	EDITION	DATE	TIME	DAY/REV	PAGE
APOLLO 9	FINAL	FEBRUARY 3, 1969	58:00 -- 60:00	3/37-38	3-37



# FLIGHT PLAN

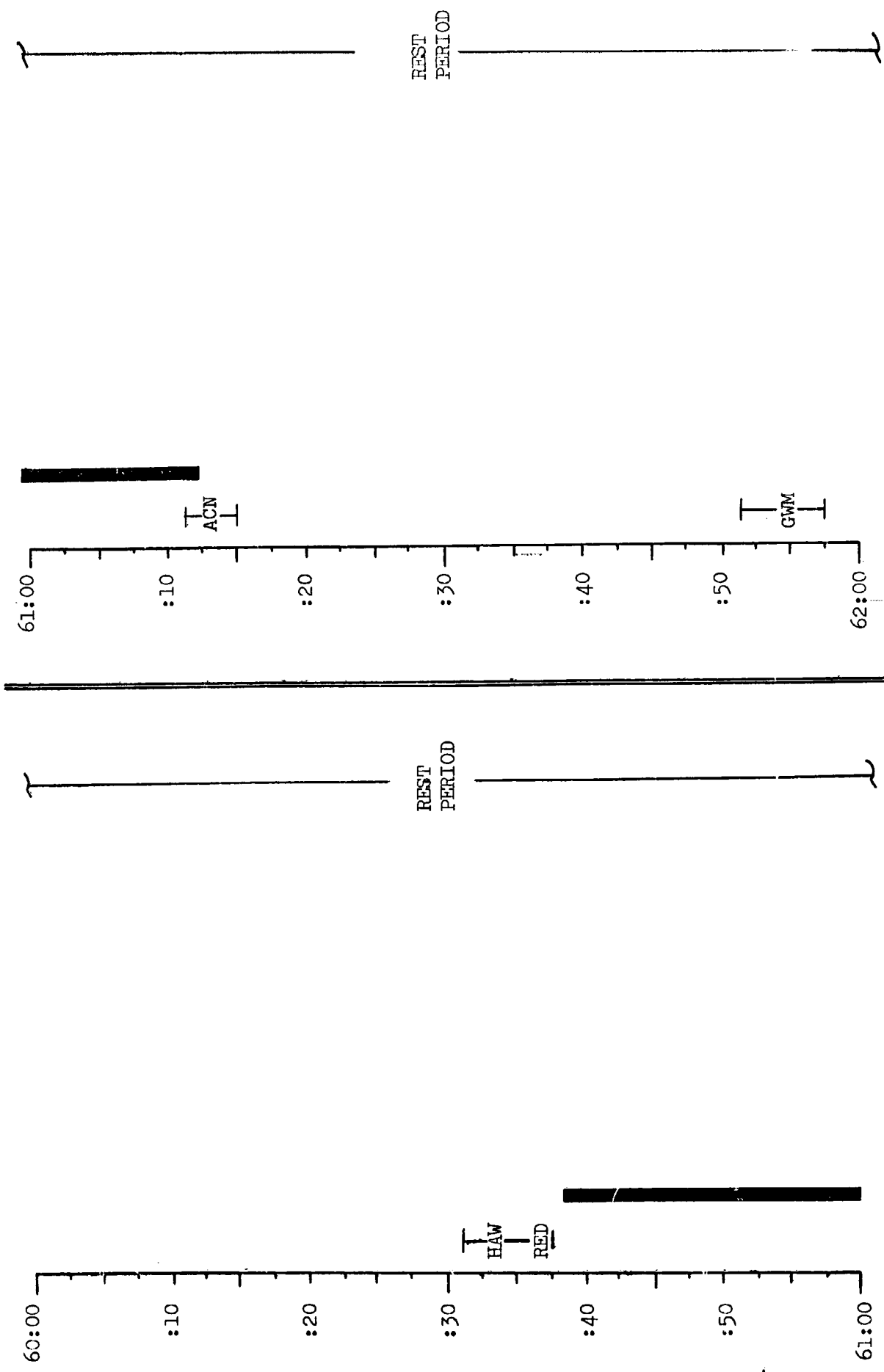

MISSION	EDITION	DATE	TIME	DAY/REV	PAGE
APOLLO 9	FINAL	FEBRUARY 3, 1969	60:00 - 62:00	3 38-39	3-38

# FLIGHT PLAN

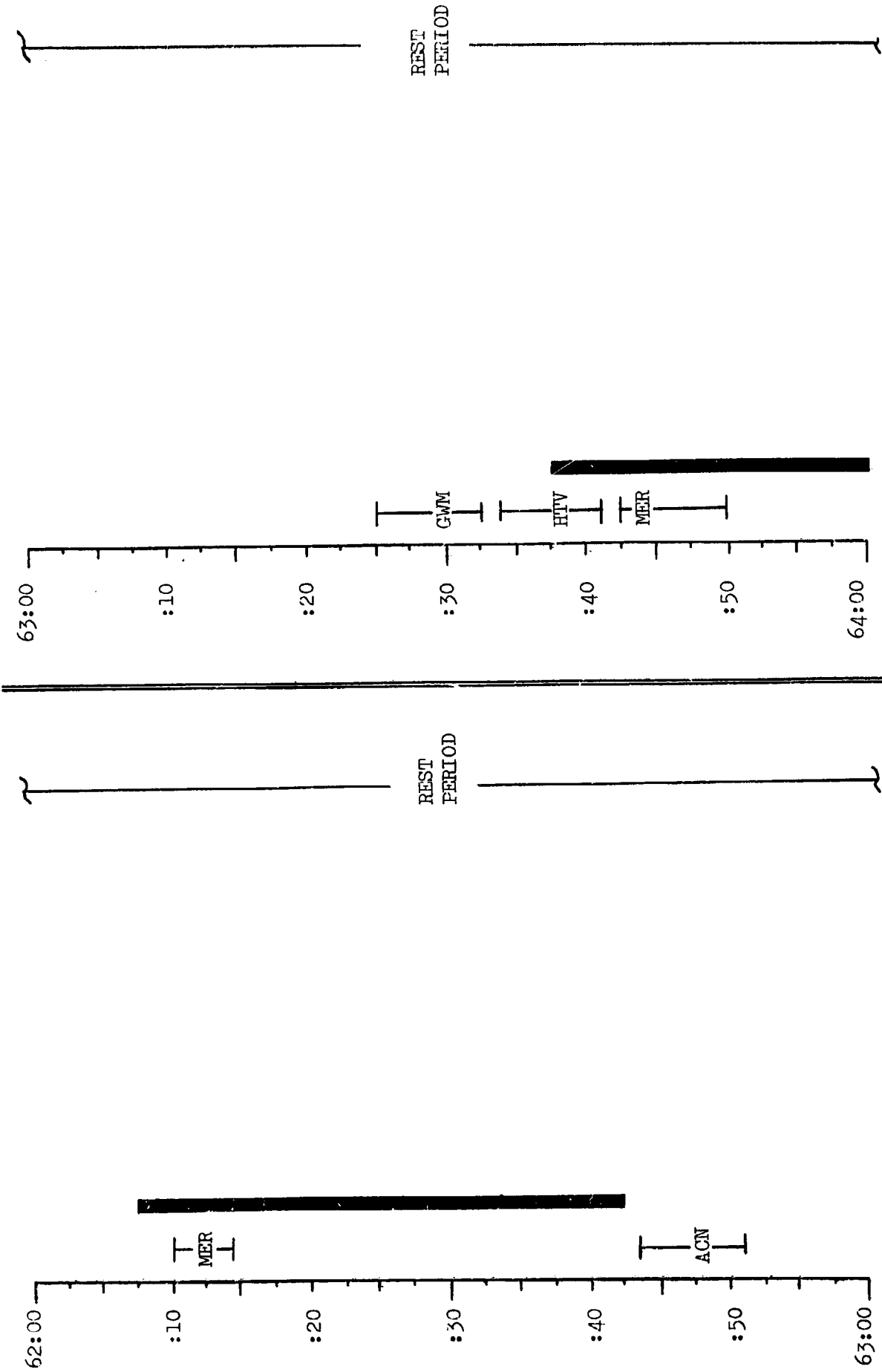

MISSION	EDITION	DATE	TIME	DAY/REV	PAGE
APOLLO 9	FINAL	FEBRUARY 3, 1969	62:00 - 64:00	3/39-30	3-39

# FLIGHT PLAN

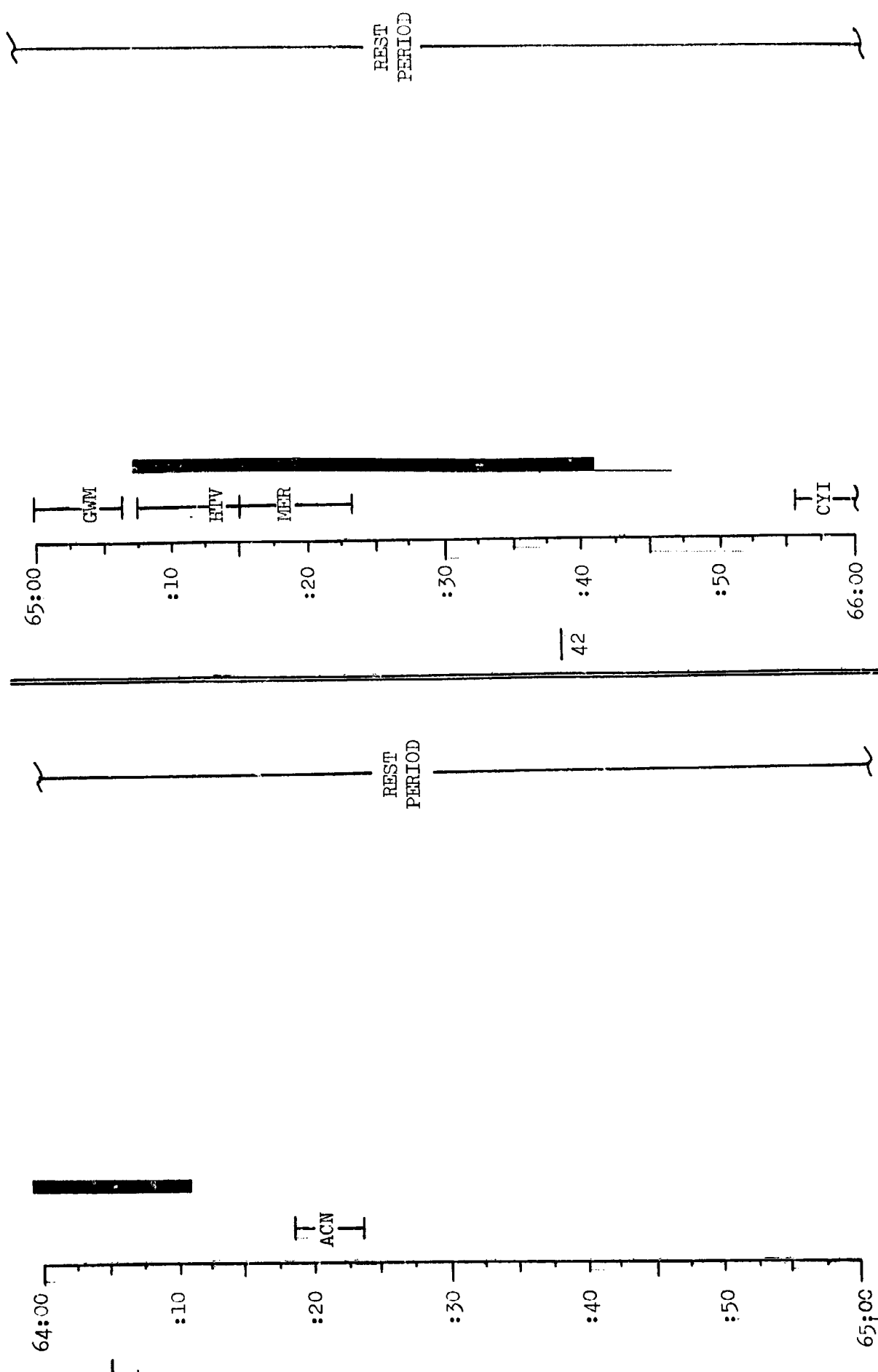

MISSION	EDITION	DATE	TIME	DAY/REV	PAGE
APOLLO 9	FINAL	FEBRUARY 3, 1969	64:00 - 66:00	3/40-42	3-40

# FLIGHT PLAN

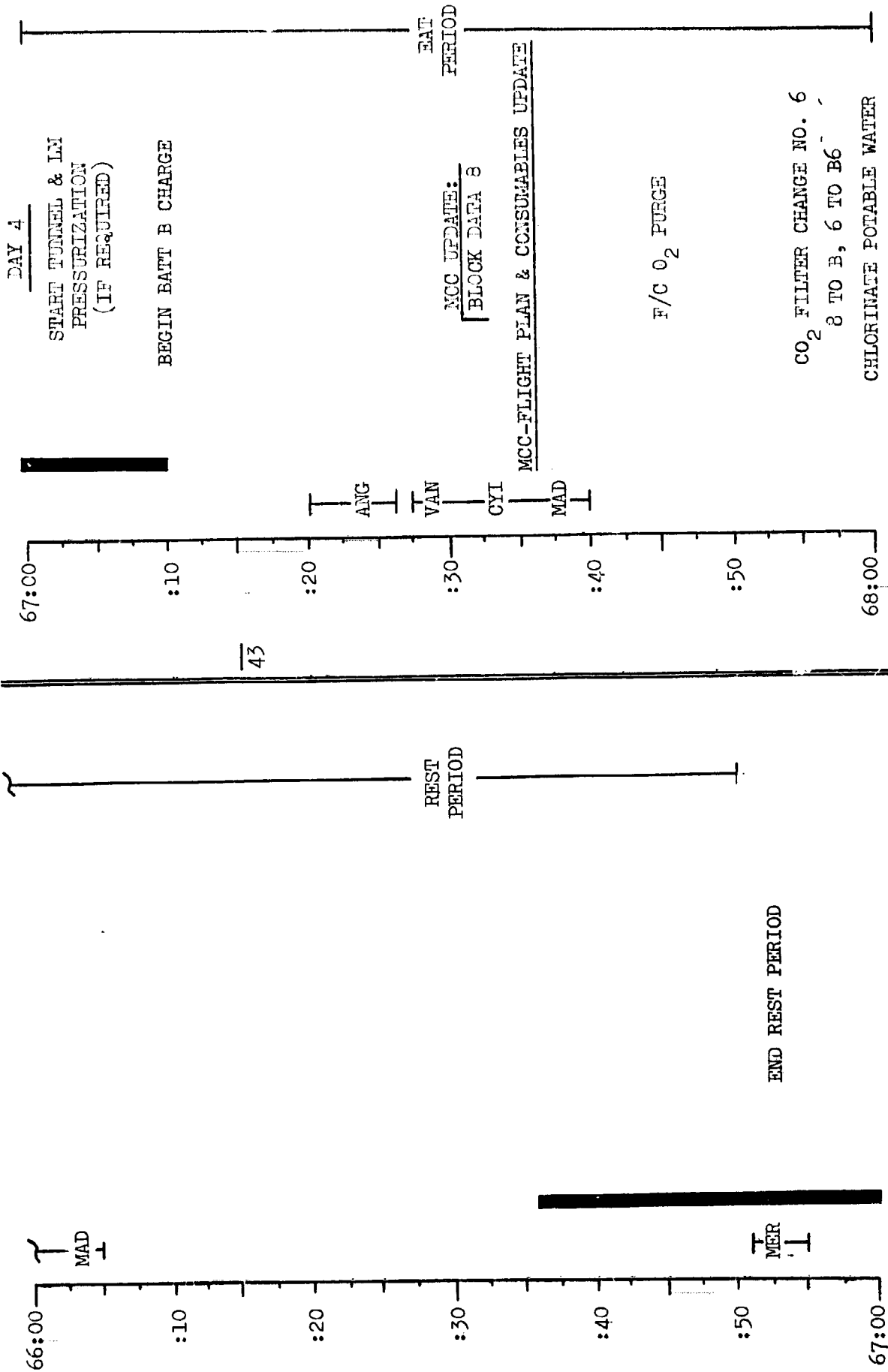

MISSION	EDITION	DATE	TIME	DAY/REV	PAGE
APOLLO 9	FINAL	FEBRUARY 3, 1969	66:00 - 68:00	3-4/42-43	3-41

# FLIGHT PLAN

CSM

LM

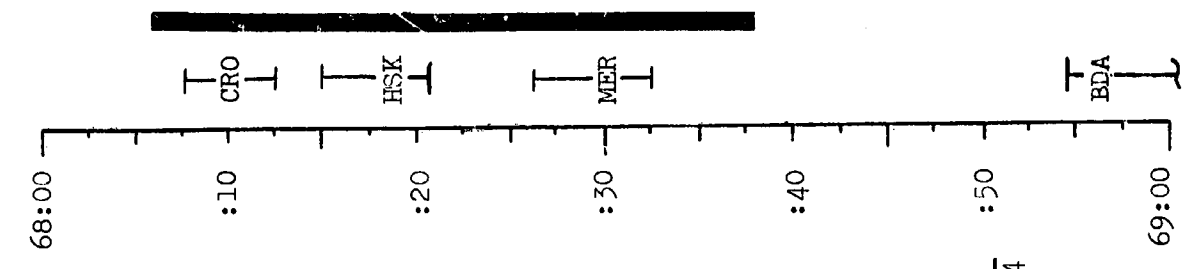
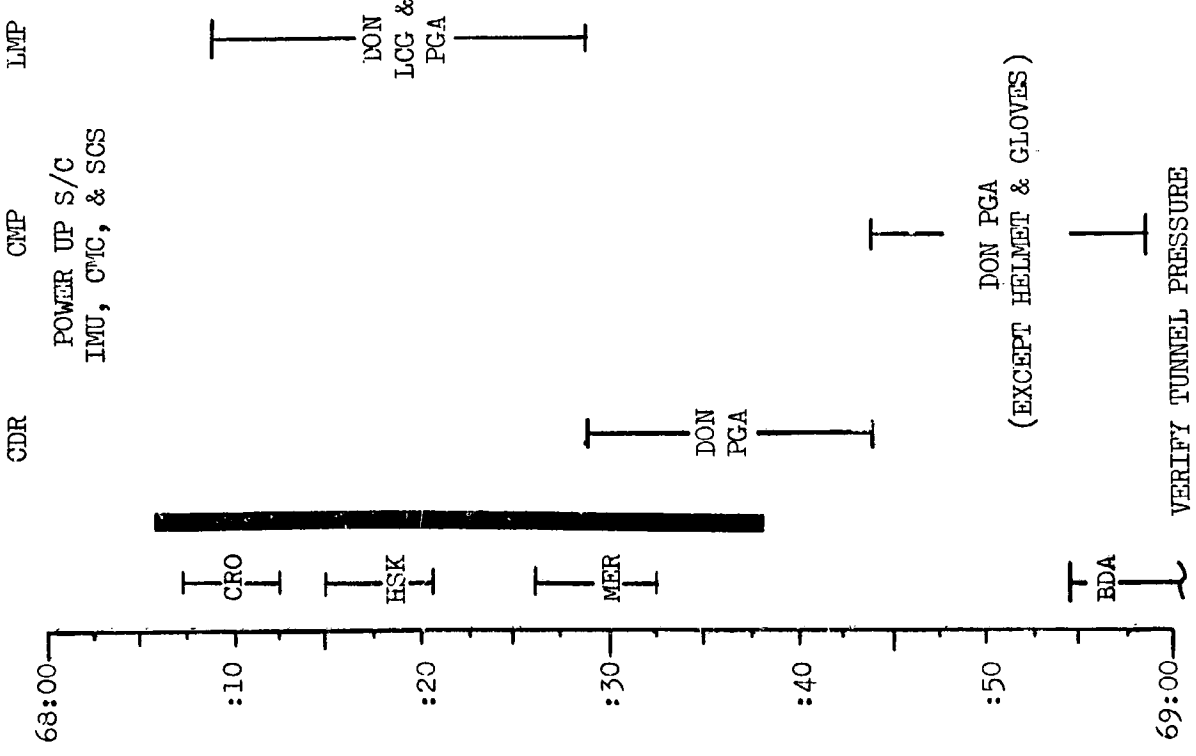

NO  
LUNAR MODULE  
ACTIVITY

MISSION	EDITION	DATE	TIME	DAY/REV	PAGE
APOLLO 9	FINAL	FEBRUARY 3, 1969	68:00 - 69:00	4/43-44	3-42

# FLIGHT PLAN

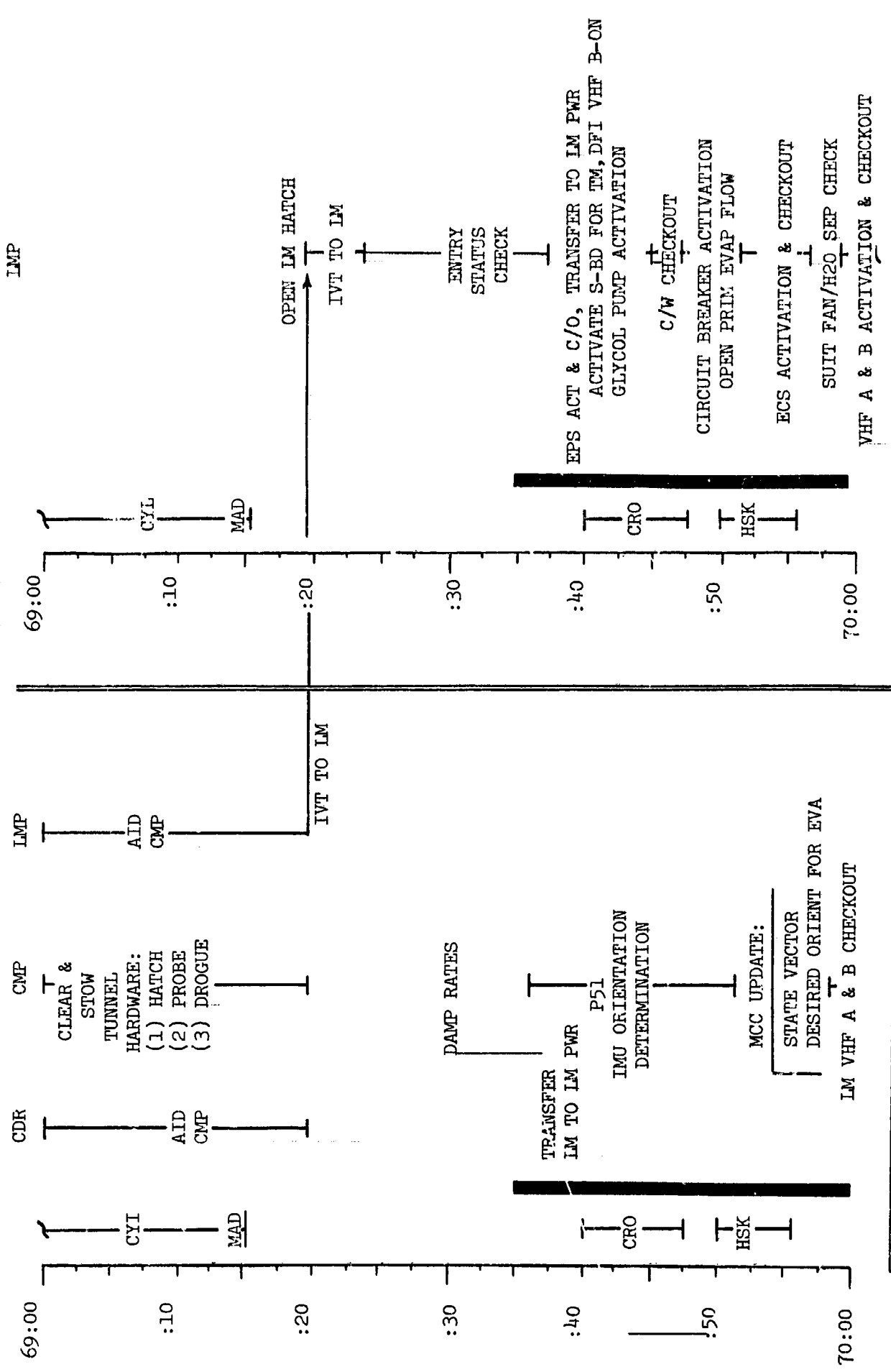

MISSION	EDITION	DATE	TIME	DAY/REV	PAGE
APCLLO 9	FINAL	FEBRUARY 3, 1969	69:00 - 70:00	4/44	3-43

# FLIGHT PLAN

## CSM

## IM

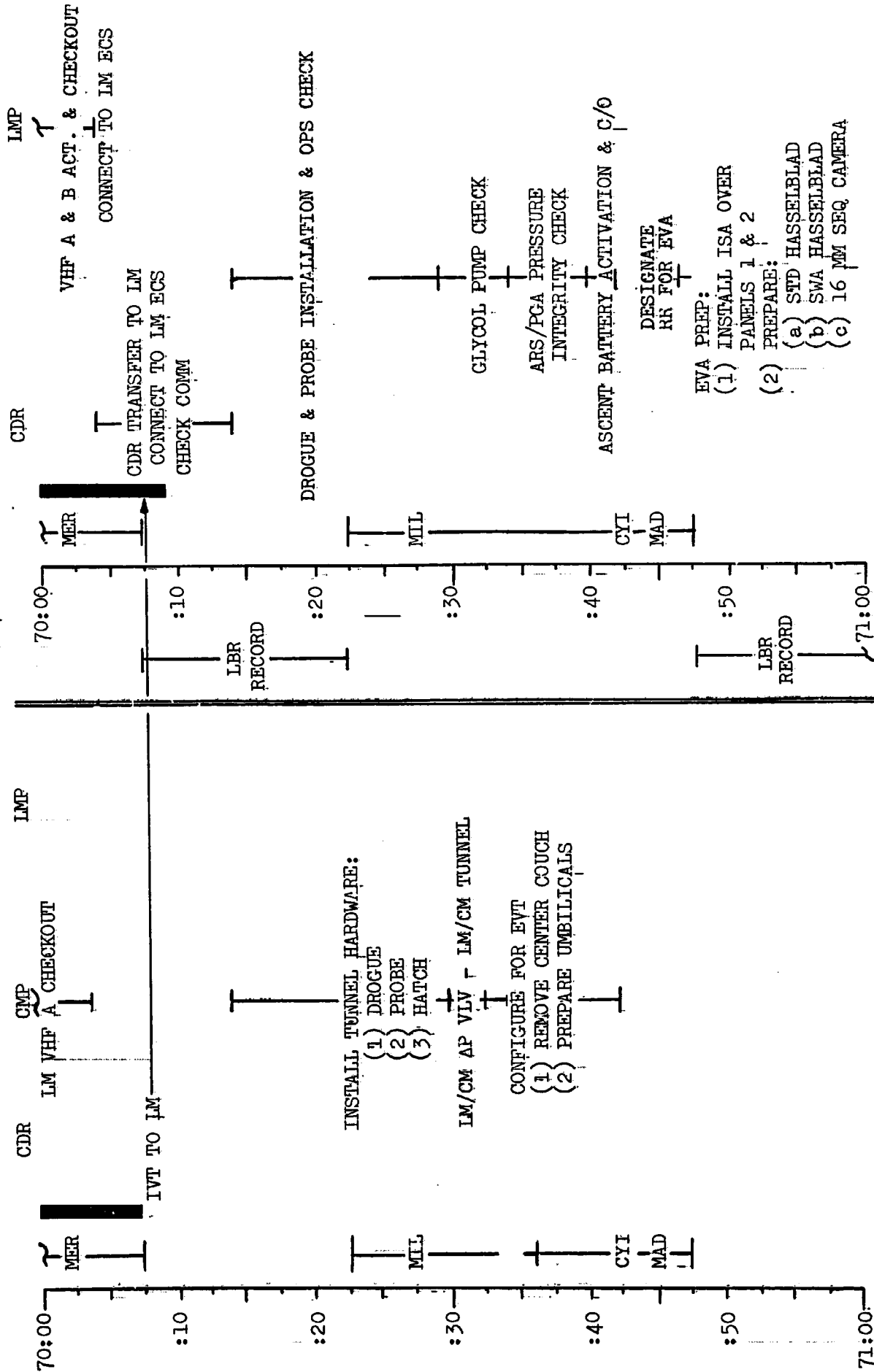

MISSION	EDITION	DATE	TIME	DAY/REV	PAGE
APOLLO 9	FINAL	FEBRUARY 3, 1969	70:00 - 71:00	4/44-45	3-44

42

45

# FLIGHT PLAN

CSM

CMP

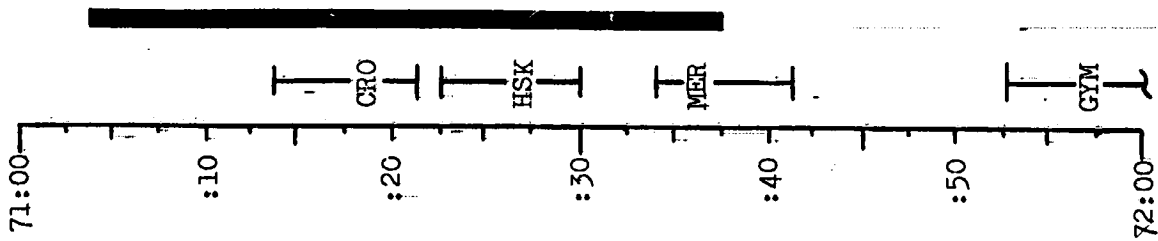

46

MCC-GO/NO GO FOR 63-1

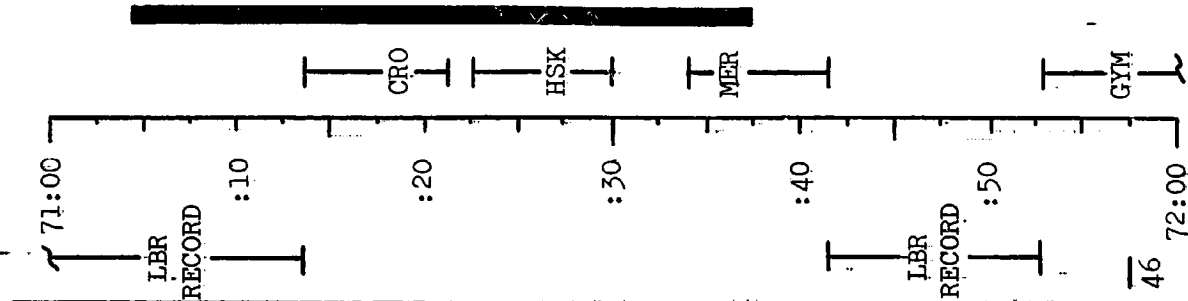

IM

CDR

- EVA PREP (CONT)
- (3) CDR & IMP SWITCH POSITIONS
  - (4) ATTACH PLSS TO OPS
  - (5) PREPARE PLSS FOR DOWNING
  - (6) DON PLSS/OPS
  - (7) CONNECT RCU

PLSS  
COMM  
CHECK

(PRIME EVA MODE)

EAT  
PERIOD

MISSION	EDITION	DATE	TIME	DAY/REV	PAGE
APOLLO 9	FINAL	FEBRUARY 3, 1969	71:00 - 72:00	4/45-46	3-45



# FLIGHT PLAN

CSM

CMF

MNVR TO EVA ATTITUDE

(DEFINED BY:

- (1) CSM -Z AXIS AT SUN
- (2) +X AXIS SOUTH
- (3) THEN PITCH DOWN 15°
- (4) ROLL LEFT 80°

FDAL READS 0, 0, 0

DISABLE SM RCS  
QUADS A&B

ATT HOLD @ MAX DB

MCC GO/NO GO FOR DEPRESS

ECS PREP & CABIN PREP:

- (1) MOUNT SEQ CAMERA ON HATCH
- (2) VERIFY CAMERA OPERATION
- (3) VERIFY REPRESS BOTTLES
- (4) VERIFY SURGE TANK
- (5) EXTERIOR LFS ON
- (6) ANTI-FOG HELMETS
- (7) DON HELMET & GLOVES

PGA PRESSURE  
INTEGRITY CHECK

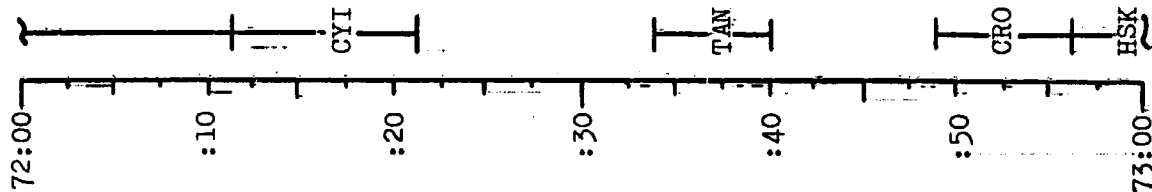

IM

CDR

IMP



MCC-GO/NO GO FOR DEPRESS

FINAL PREP:

- (1) C/W CHECK
- (2) CABIN FANS OFF
- (3) ANTI-FOG HELMETS
- (4) DON HELMETS, GLOVES, & VISORS
- (5) ATTACH TETHER TO LMP
- (6) LMP CONNECT TO PLSS ECS

CDR PRESSURE  
INTEGRITY CHECK

LMP PRESSURE  
INTEGRITY CHECK

DEPRESS LM  
OPEN FWD HATCH

OPEN PLSS FEEDWATER

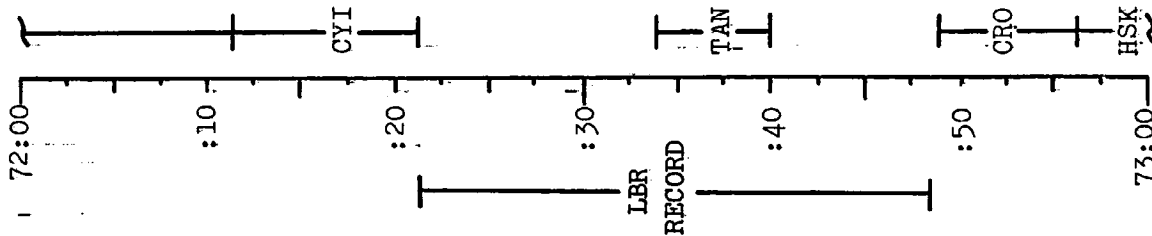

MISSION	EDITION	DATE	TIME	DAY/REV	PAGE
APOLLO 9	FINAL	FEBRUARY 3, 1969	72:00 - 73:00	4/46	3-46

# FLIGHT PLAN

CSM

CMP

LMP

CDR

LMP  
ALLOW FOR COOLING

73:00

HSK

HTV

DEPRESS CM  
OPEN CM SIDE HATCH  
INGRESS LH COUCH  
SEQ CAMERA-ON

:10

RTC  
VOICE Bμ

SEQ CAMERA-OFF  
SEQ CAMERA-ON

:20

RTC  
VOICE Bμ

SEQ CAMERA-OFF  
PARTIALLY INGRESS CM

:30

REST & COMMENT  
RETRIEVE THERMAL SAMPLES  
REST & COMMENT

47

SEQ CAMERA-ON  
SEQ CAMERA-OFF  
SEQ CAMERA-ON

:40

EGRESS CM

SEQ CAMERA-ON  
SEQ CAMERA-OFF  
SEQ CAMERA-ON

:50

RTC  
VOICE Bμ

SEQ CAMERA-ON

74:00

73:00

HSK

HTV

:10

VERIFY SEQ  
CAMERA OPERATION-ON

EGRESS (pg. 4-47)

SEQ CAMERA-OFF  
SEQ CAMERA-ON

:20

MOUNT SEQ  
CAMERA  
DON GOLDEN SLIPPERS  
REST & COMMENT

:30

EVT TO CM

:40

SEQ CAMERA-OFF  
SEQ CAMERA-ON

:50

EVT TO LM  
DON GOLDEN SLIPPERS  
REST & COMMENT  
MOVE TO LADDER  
PASS SEQ CAMERA TO CDR  
DON GOLDEN SLIPPERS  
RETRIEVE THERMAL SAMPLES

MISSION	EDITION	DATE	TIME	DAY/REV	PAGE
APOLLO 5	FINAL	FEBRUARY 3, 1969	73:00 - 74:00	4/45-47	3-47

# FLIGHT PLAN

CSM  
CMP

IM

CDR

LMP

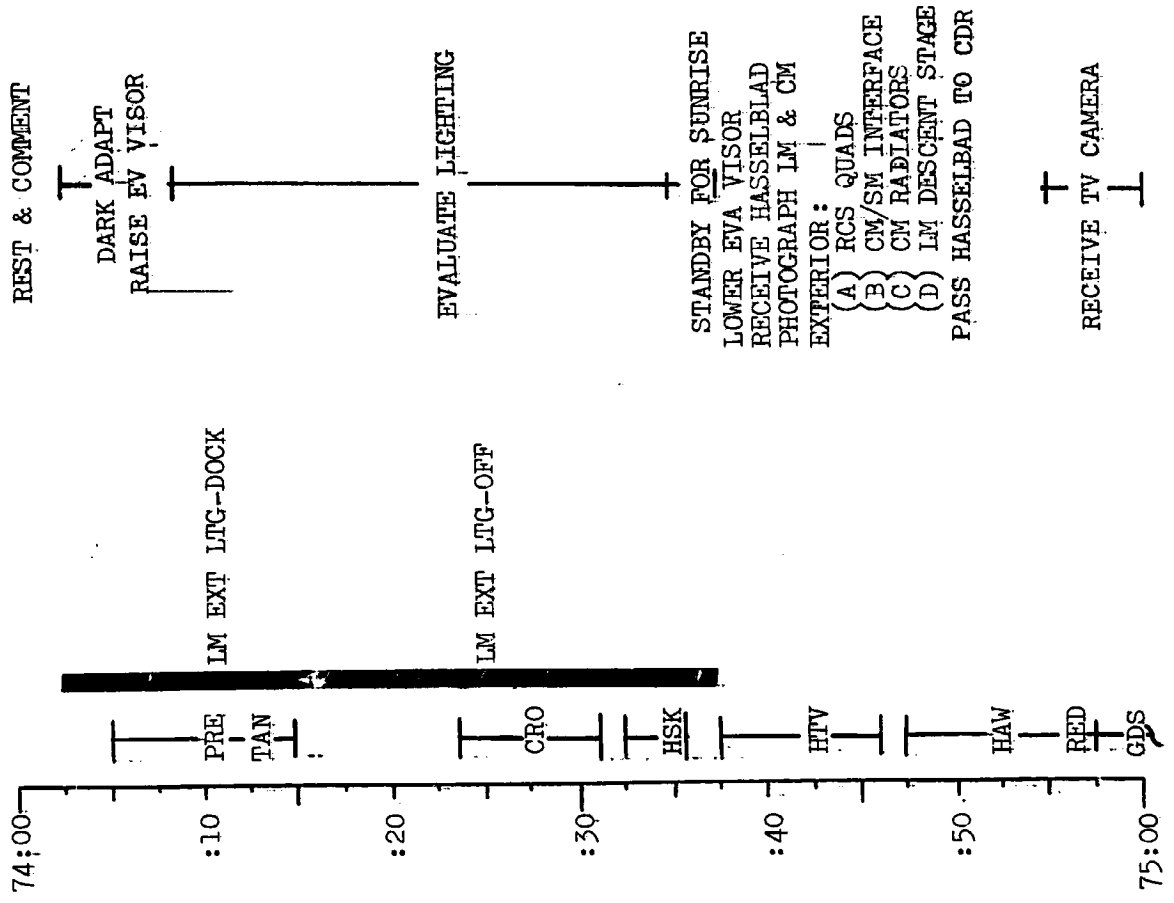
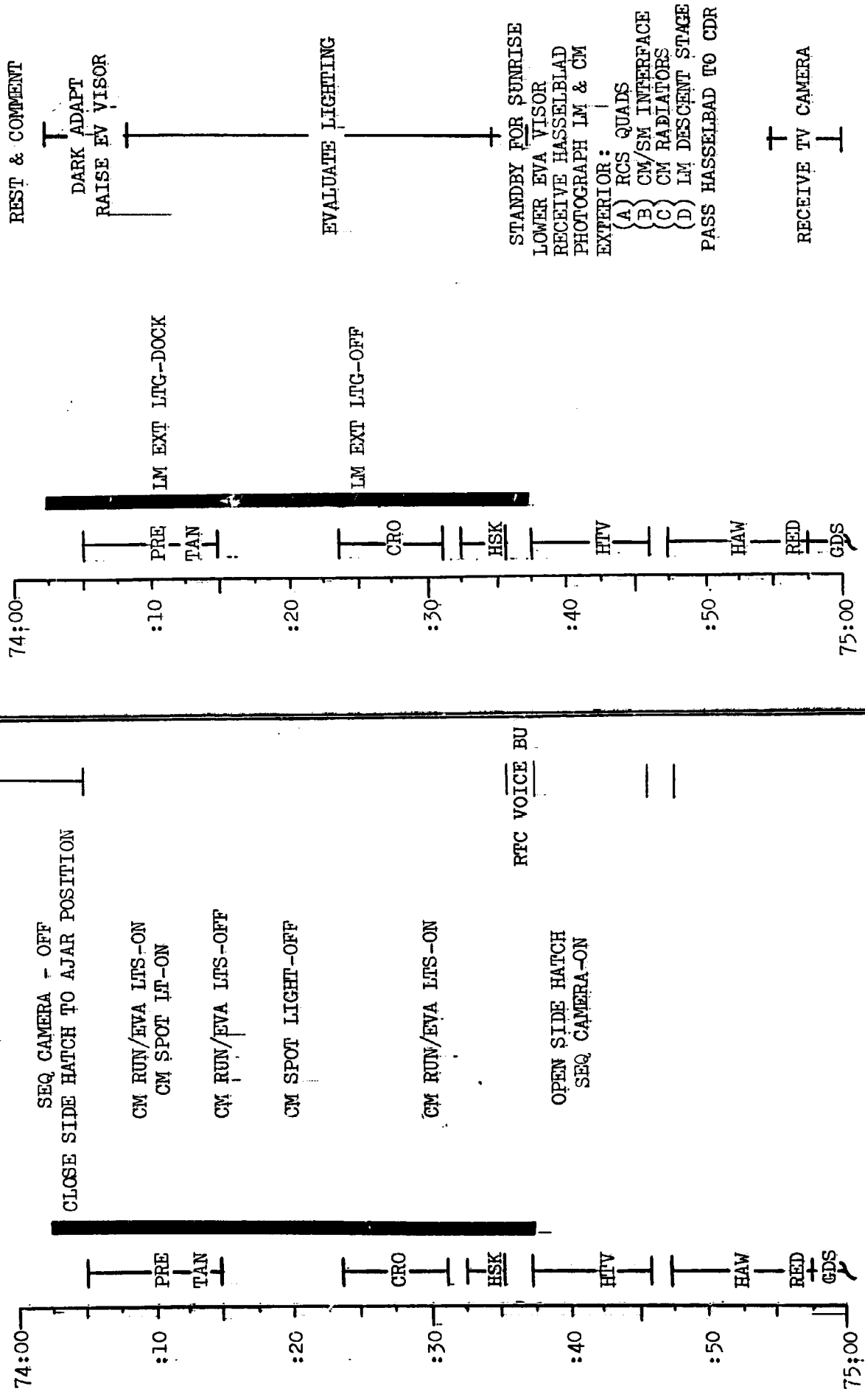

MISSION	EDITION	DATE	TIME	DAY/REV	PAGE
APOLLO 9	FINAL	FEBRUARY 3, 1969	74:00 - 75:00	4/47	3-48

**CSM FLIGHT PLAN**

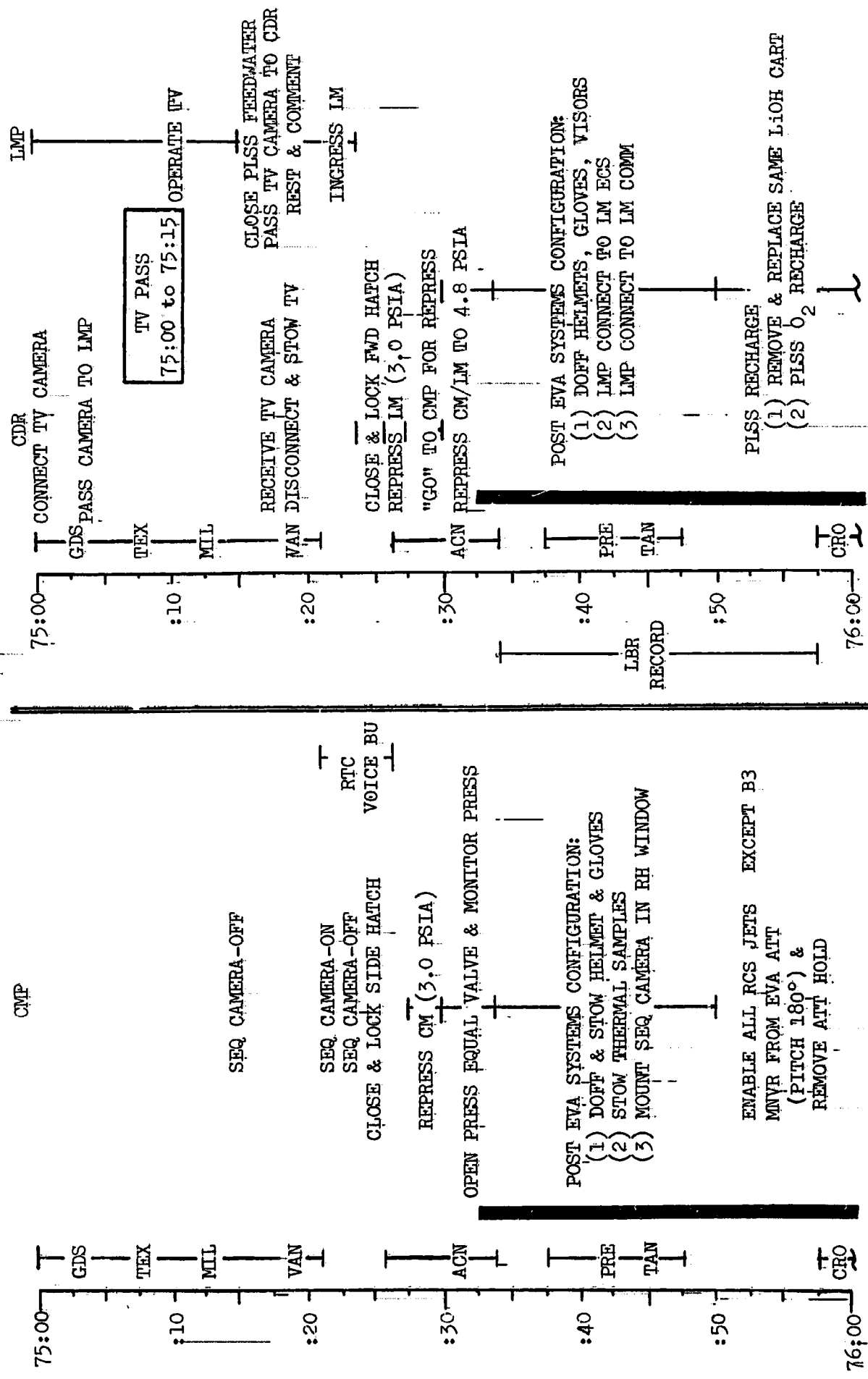

MISSION	EDITION	DATE	TIME	DAY/REV	PAGE
APOLLO 9	FINAL	FEBRUARY 3, 1969	75:00 - 76:00	A/47-48	3-49

# FLIGHT PLAN

CSM  
CMP

CDR

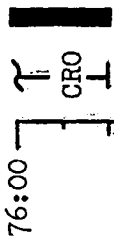

CLEAR & STOW TUNNEL HARDWARE:  
 (1) HATCH  
 (2) PROBE  
 (3) DROGUE

IWT TO CSM

EAT PERIOD

IM  
CDR

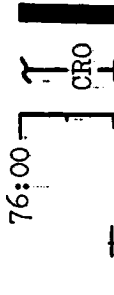

PISS RECHARGE  
 PISS/OPS DOFFING:  
 (1) REMOVE & STOW RCU  
 (2) DOFF PISS/OPS  
 (3) REPLACE PISS BATTERY  
 (4) REMOVE OPS FROM PISS  
 (5) STOW PISS & OPS  
 PISS WATER RECHARGE  
 REMOVE & REPLACE PRIM LiOH CART (Pg 4-50)  
 POST EVA CABIN CLEANUP:  
 (1) RESTOW SEQ CAMERA  
 (2) RESTOW SWA HASSELBLAD  
 (3) RESTOW STD HASSELBLAD  
 (4) STOW FILM, EVA DATA & THERMAL SAMPLE IN ISA  
 OPEN IM OVHD HATCH  
 CDR TRANSFER TO CSM  
 IWT TO CSM

IM CONNECT TO CSM ECS  
 PRIM EVAP FLOW-CLOSE  
 INITIAL POWER DOWN  
 EAT PERIOD  
 SUBLIMATOR DRYOUT (30 min)

MISSION	EDITION	DATE	TIME	DAY/REV	PAGE
APOLLO 9	FINAL	FEBRUARY 3, 1969	76:00 - 77:00	4/48-49	3-50

# FLIGHT PLAN

# CSM

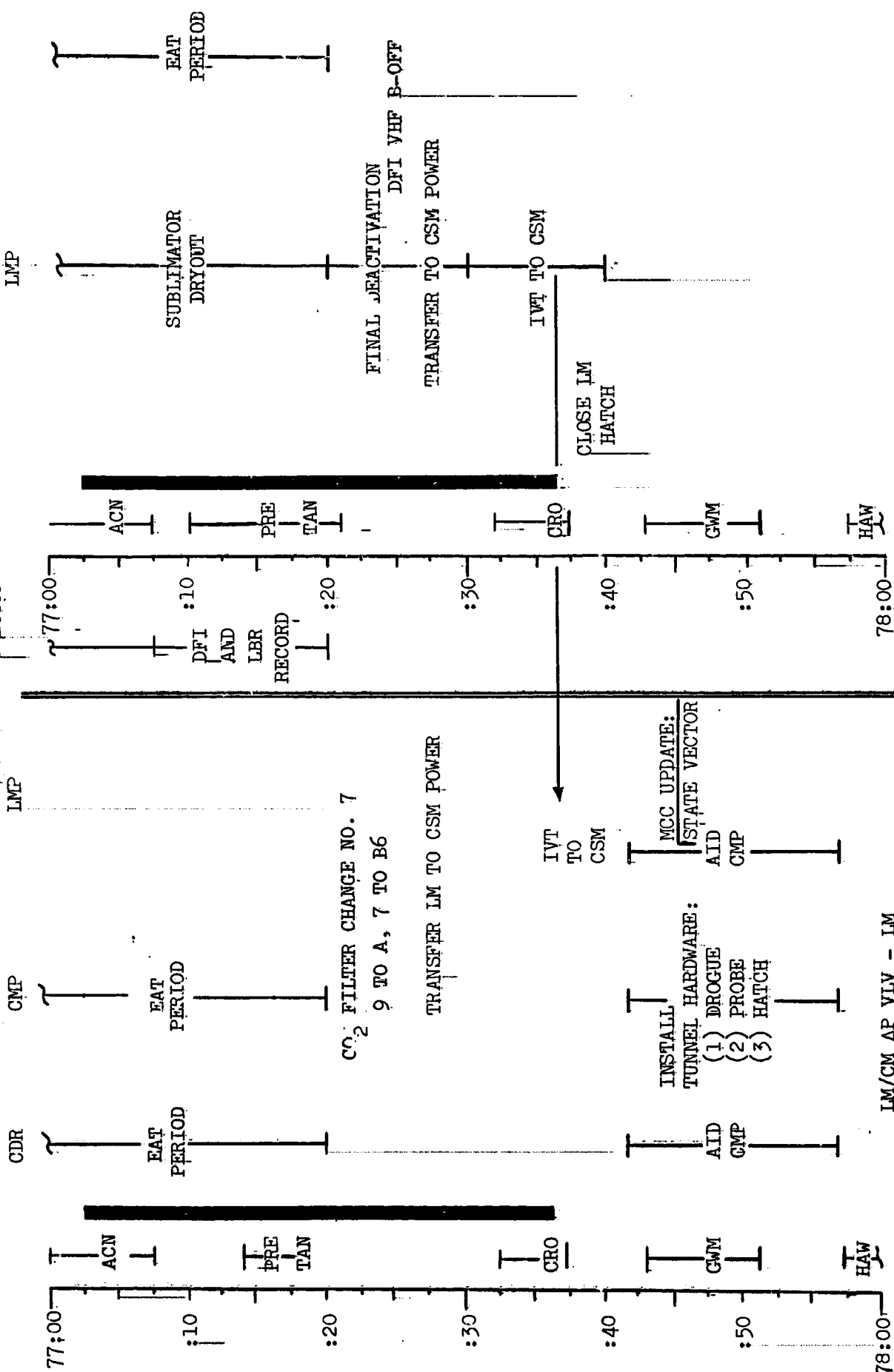

MISSION	EDITION	DATE	TIME	DAY/REV	PAGE
APOLLO 9	FINAL	FEBRUARY 3, 1969	77:00 - 78:00	4/49	3-51

# FLIGHT PLAN

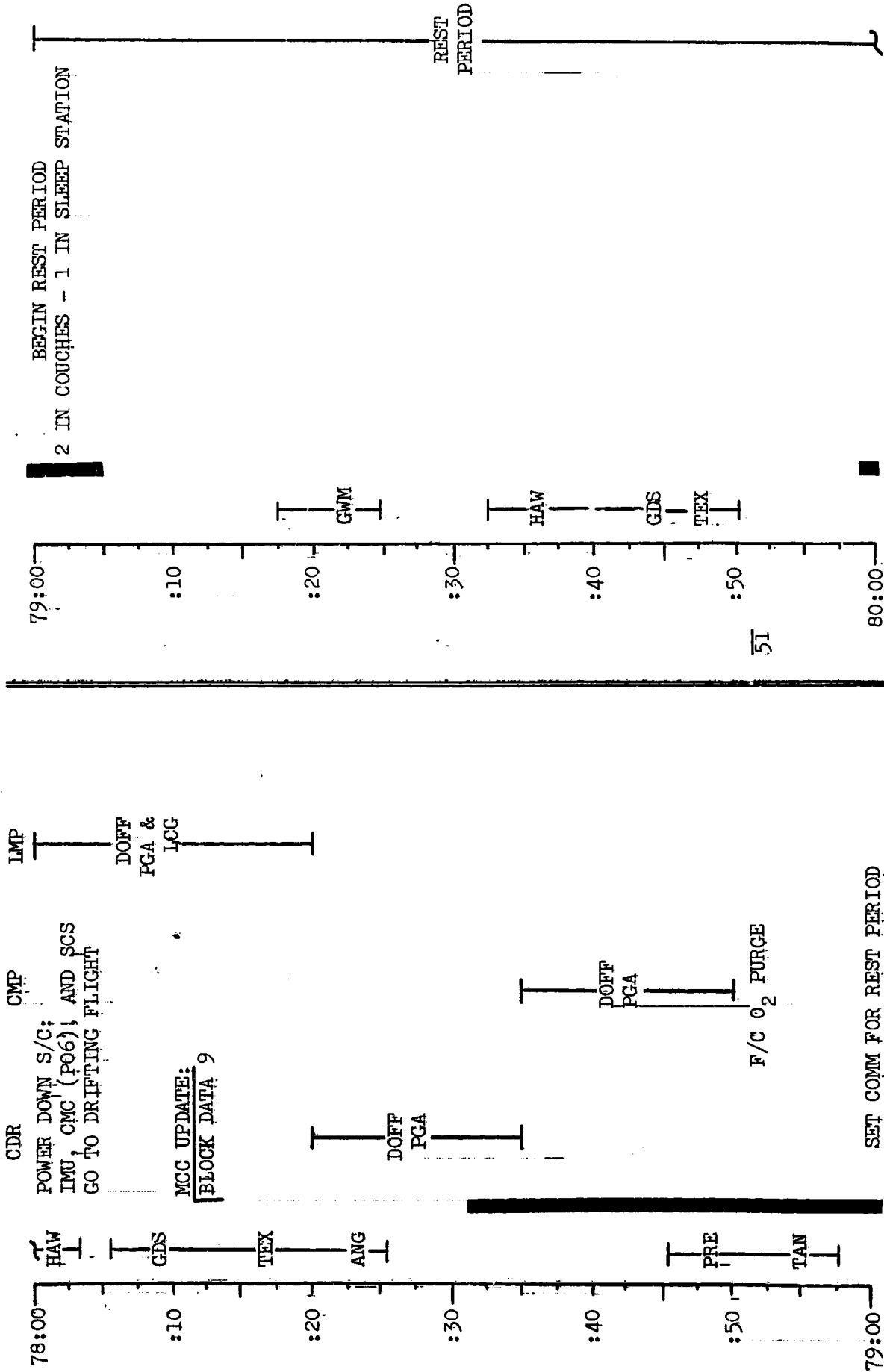

MISSION	EDITION	DATE	TIME	DAY/REV	PAGE
APOLLO 9	FINAL	FEBRUARY 3, 1969	78:00 - 80:00	4/49-51	3-52

SET COMM FOR REST PERIOD

# FLIGHT PLAN

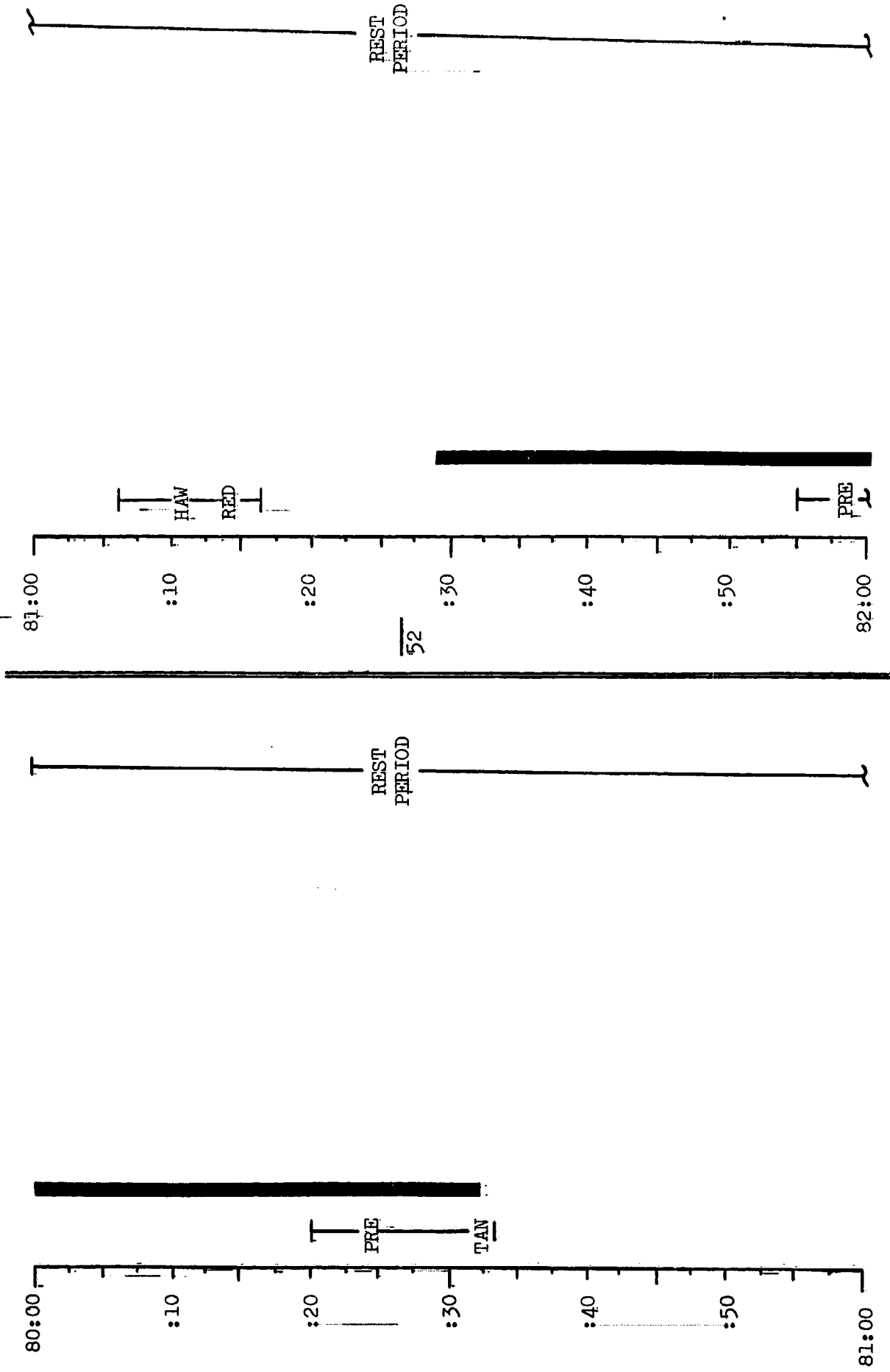

MISSION	EDITION	DATE	TIME	DAY/REV	PAGE
APOLLO 9	FINAL	FEBRUARY 3, 1969	80:00 - 82:00	4/51-52	3-53



# FLIGHT PLAN

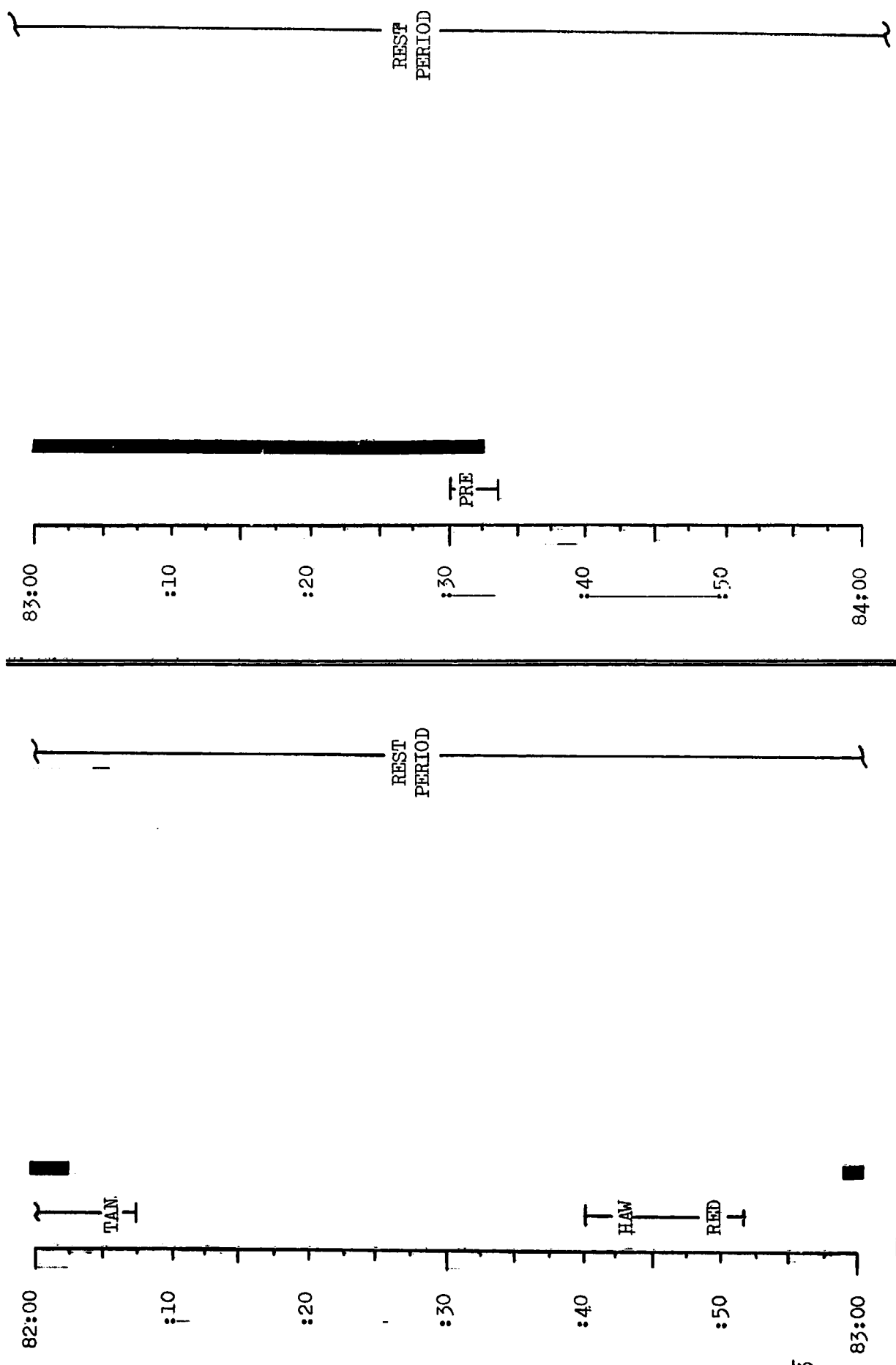

MISSION	EDITION	DATE	TIME	DAY/REV	PAGE
APOLLO 9	FINAL	FEBRUARY 3, 1969	82:00 - 83:00	4/52-53	3-54

# FLIGHT PLAN

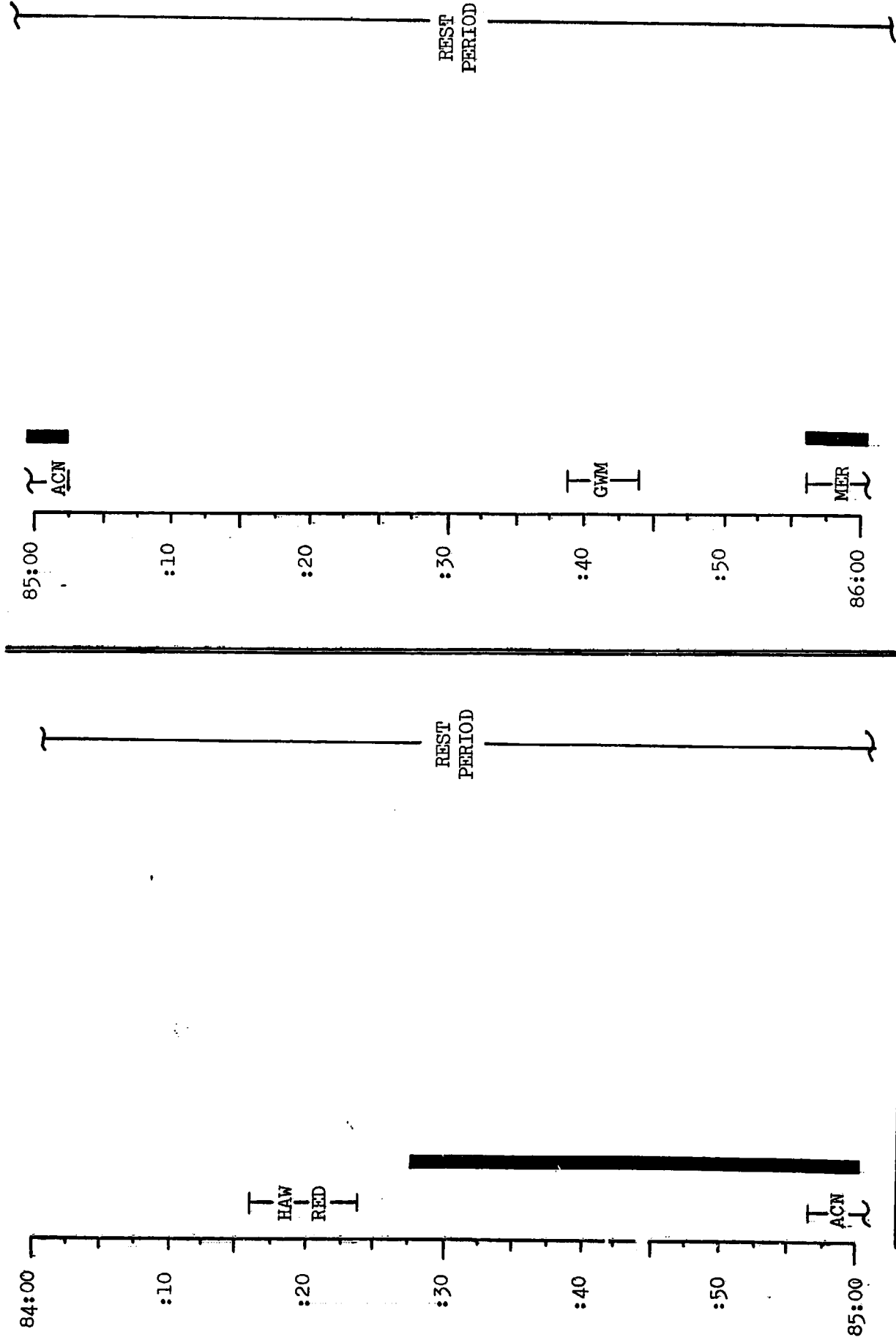

MISSION	EDITION	DATE	TIME	DAY/REV	PAGE
APOLLO 9	FINAL	FEBRUARY 3, 1969	84:00 - 86:00	4/53-54	3-55

# FLIGHT PLAN

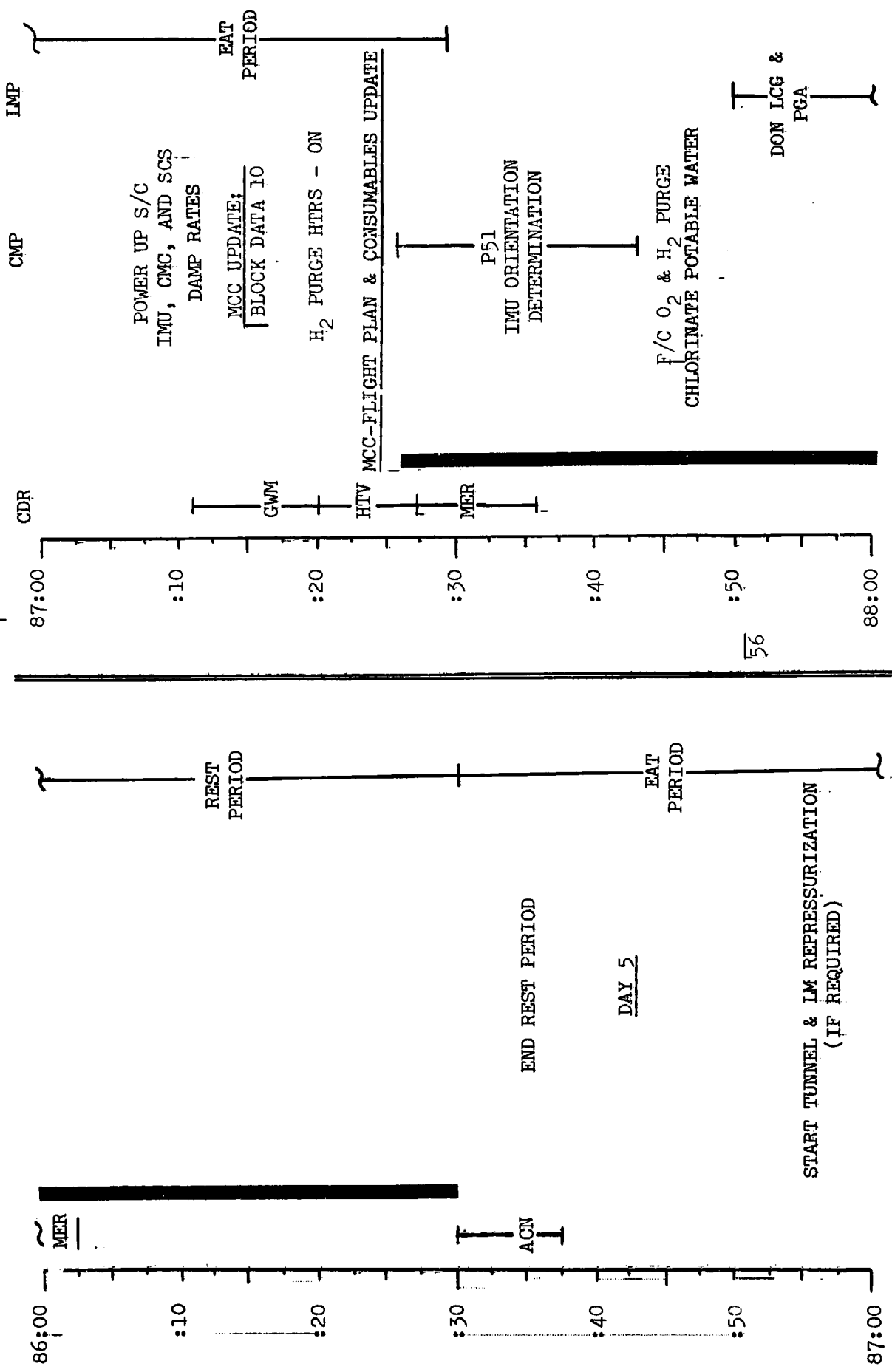

MISSION	EDITION	DATE	TIME	DAY/REV	PAGE
APOLLO 9	FINAL	FEBRUARY 3, 1969	86:00 - 88:00	4-5/55-56	3-56

IM

**FLIGHT PLAN**

CSM

LMP

CDR

CMP

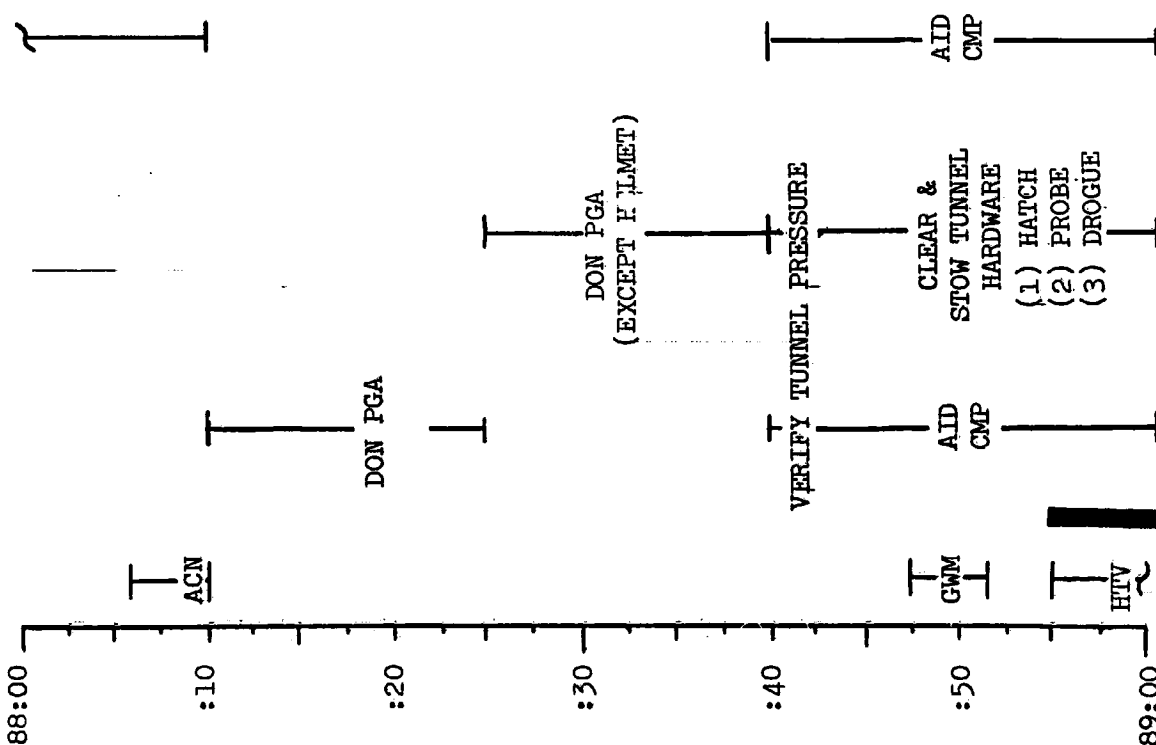
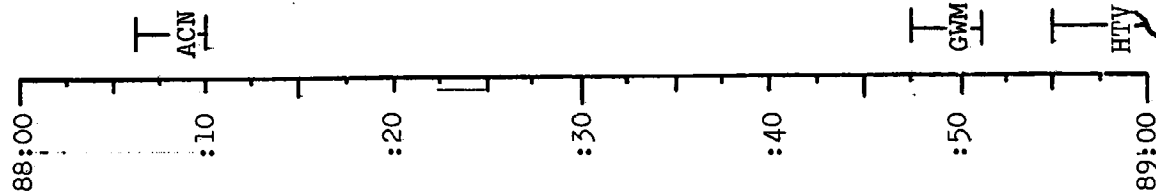

NO IM  
ACTIVITIES

MISSION	EDITION	DATE	TIME	DAY/REV	PAGE
APOLLO 9	FINAL	FEBRUARY 3, 1969	88:00 - 89:00	5/56-57	3-57

# FLIGHT PLAN

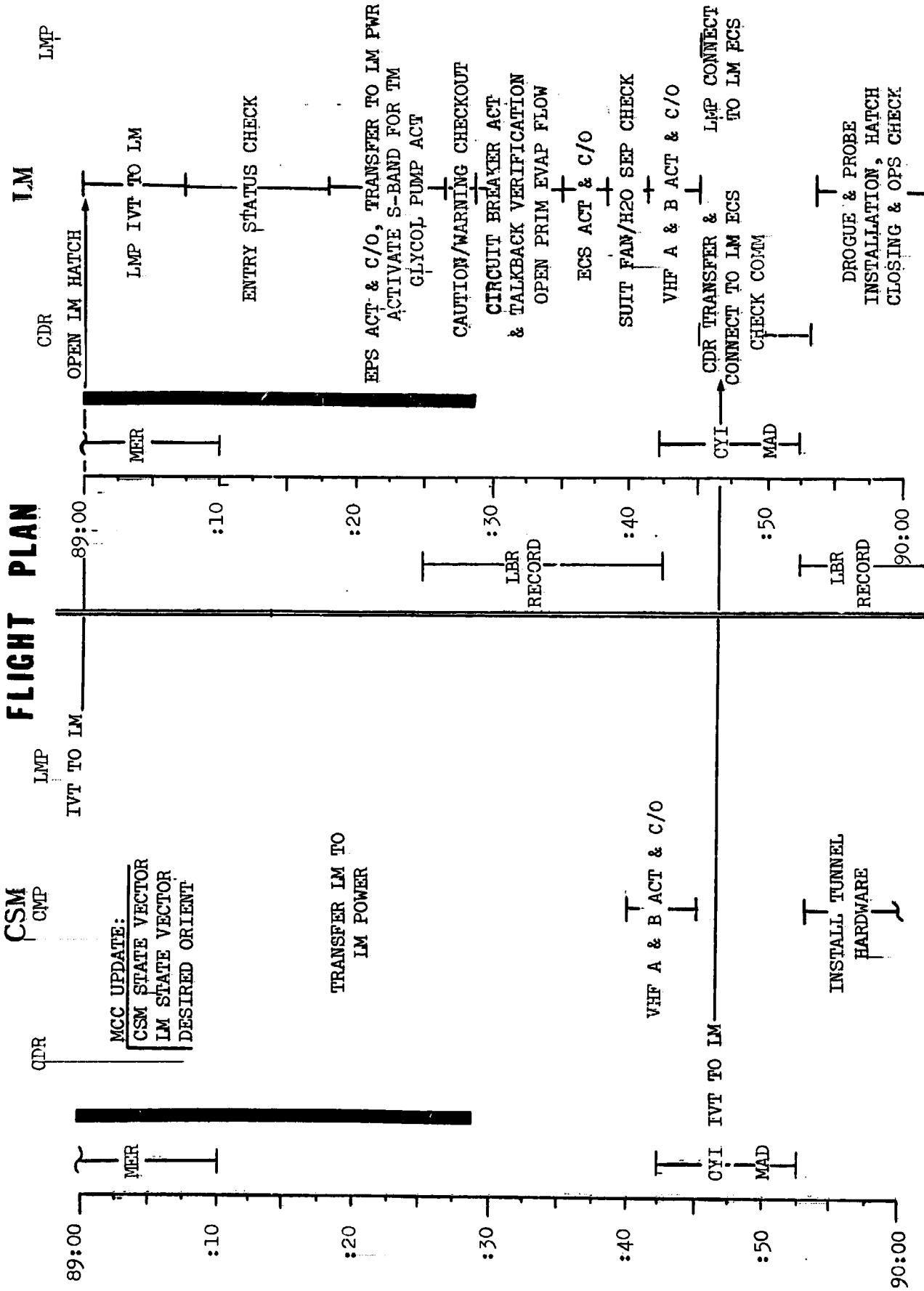

MISSION	EDITION	DATE	TIME	DAY/REV	PAGE
APOLLO 9	FINAL	FEBRUARY 3, 1969	89:00 - 90:00	5/56-57	3-58

# FLIGHT PLAN

CSM

CMP

- (1) DROGUE
- (2) PROBE
- (3) DISCONNECT UMBILICALS
- (4) FWD HATCH
- LM/CM AV VLV - OFF
- MOUNT DOCKING TARGET IN RH RNDZ WINDOW



P52  
IMU REALIGN (PREFERRED)

LM IMU COARSE ALIGN

REPORT G.E.T. TORQUED (FROM P52)  
LM/CMC CLOCK SYNC & LM T EPHM CHECK

GDC ALIGN V83 & INITIALIZE ORDEAL

EMS ACCEL TEST  
EMS TEST

ATT HOLD @ MIN DEADBAND FOR LM RCS COLD FIRE

CDR

LM

LMP

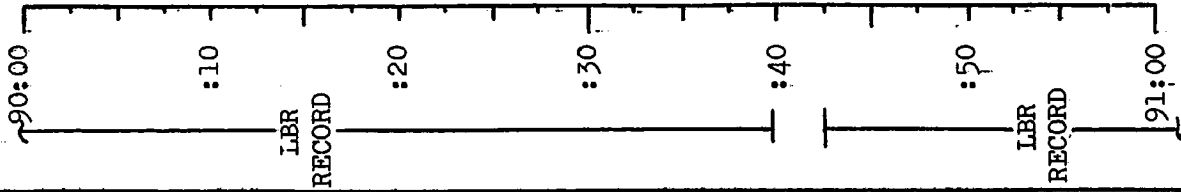

GLYCOL PUMP CHECK

ARS/PGA PRESSURE INTEGRITY CHECK

ASCENT BATTERY ACT & C/O

PGNCS TURN ON & SELF TEST

RATE GYRO CHECK

(WAIT FOR CSM ALIGNMENT)

IMU COARSE ALIGN

PASS GIMBAL ANGLES TO MCC

LGC CLOCK INITIALIZATION & T EPHM CHECK

DPS/RCS TEMP/PRESS CHECK & APS PRESSURIZATION

RCS COLD FIRE

MISSION	EDITION	DATE	TIME	DAY/REV	PAGE
APOLLO 9	FINAL	FEBRUARY 3, 1969	90:00 - 91:00	5/57	3-59

# FLIGHT PLAN

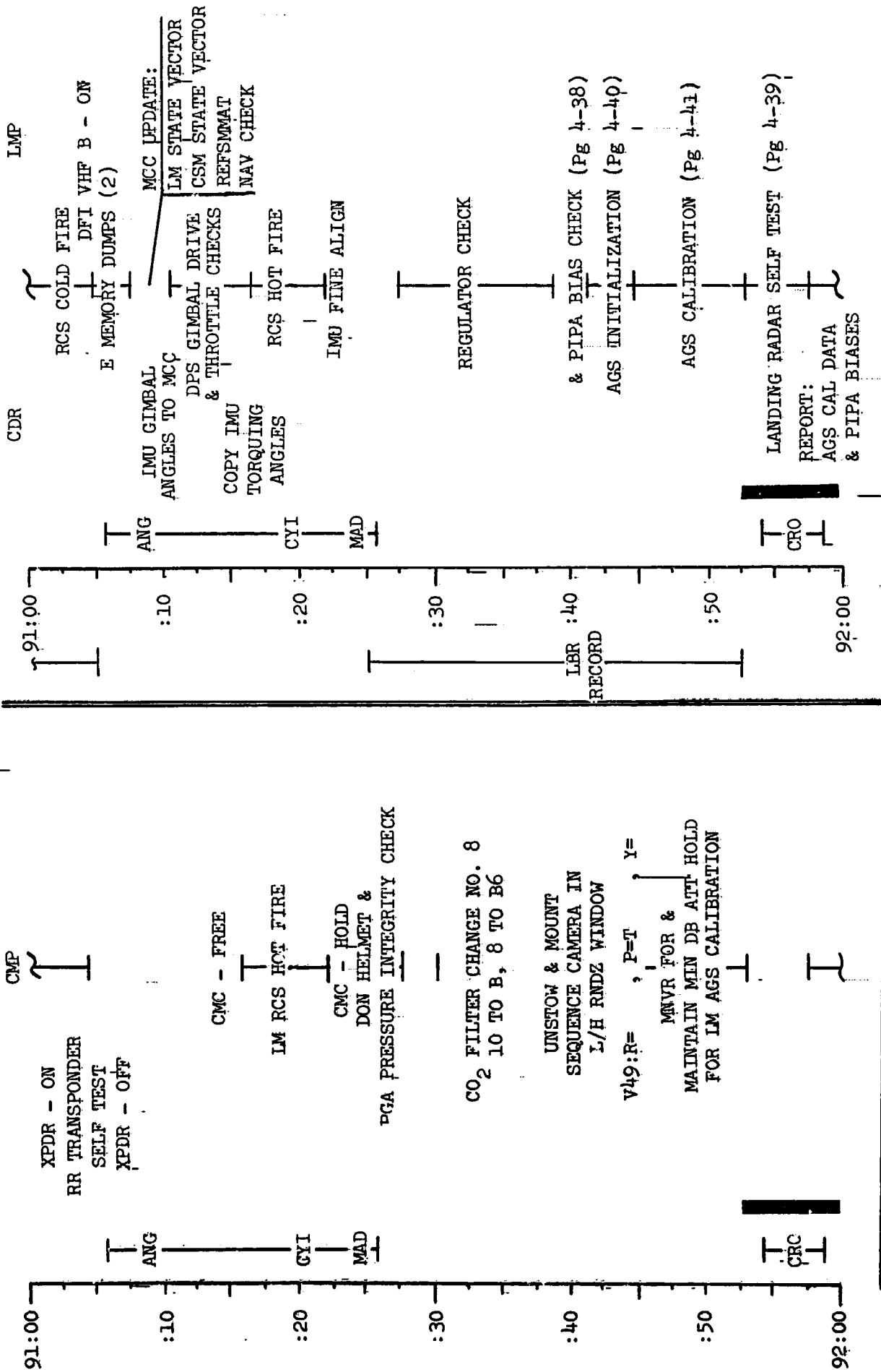

MISSION	EDITION	DATE	TIME	DAY/REV	PAGE
APOLLO 9	FINAL	FEBRUARY 3, 1969	91:00 - 92:00	5/57-58	3-60

# FLIGHT PLAN

CSM  
GMP

CDR

LMP

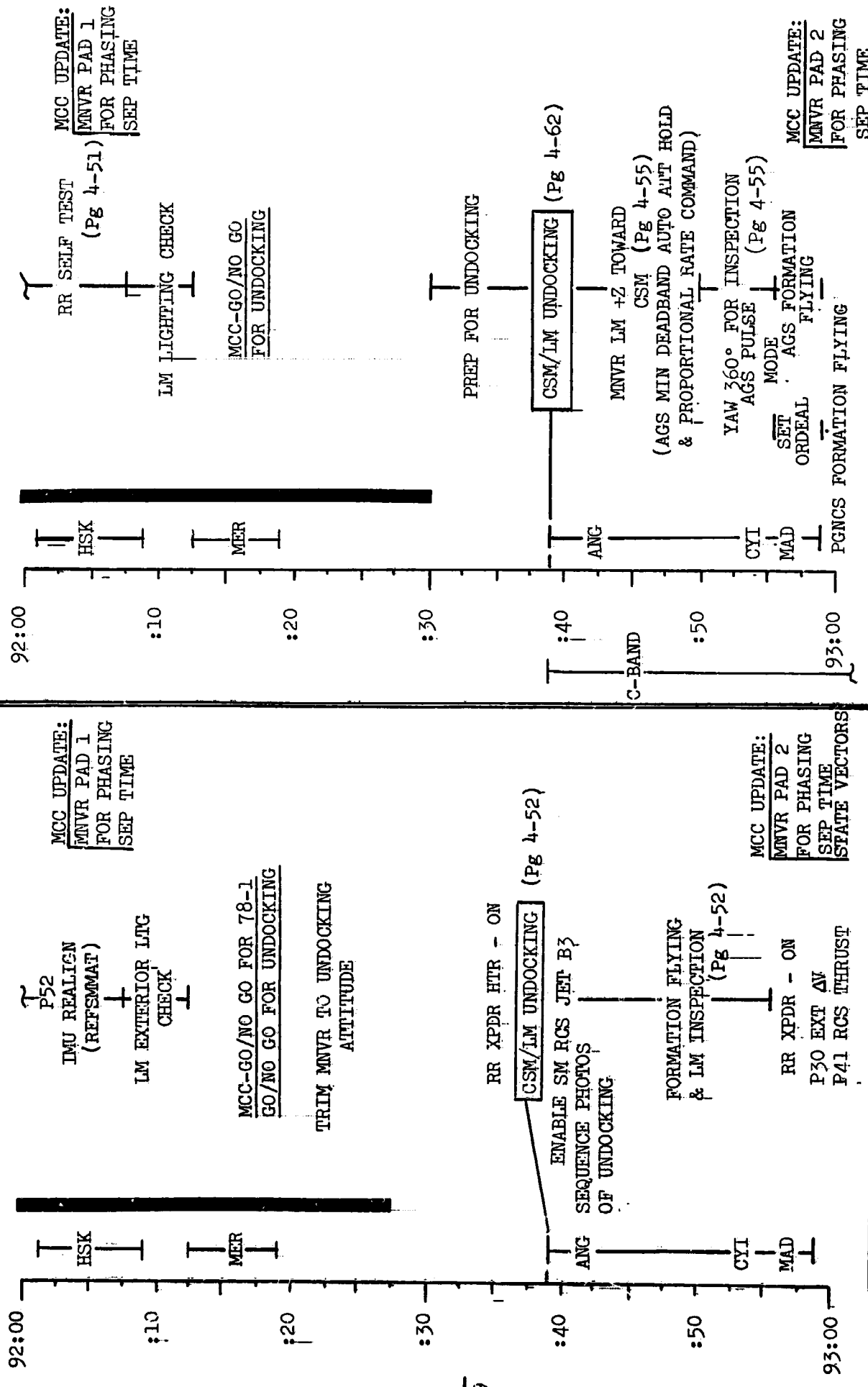

MISSION	EDITION	DATE	TIME	DAY/REV	PAGE
APOLLO 9	FINAL	FEBRUARY 3, 1969	92:00 - 93:00	5/58-59	3-61



CSM

CMP

# FLIGHT PLAN

CDR

LM

LMP

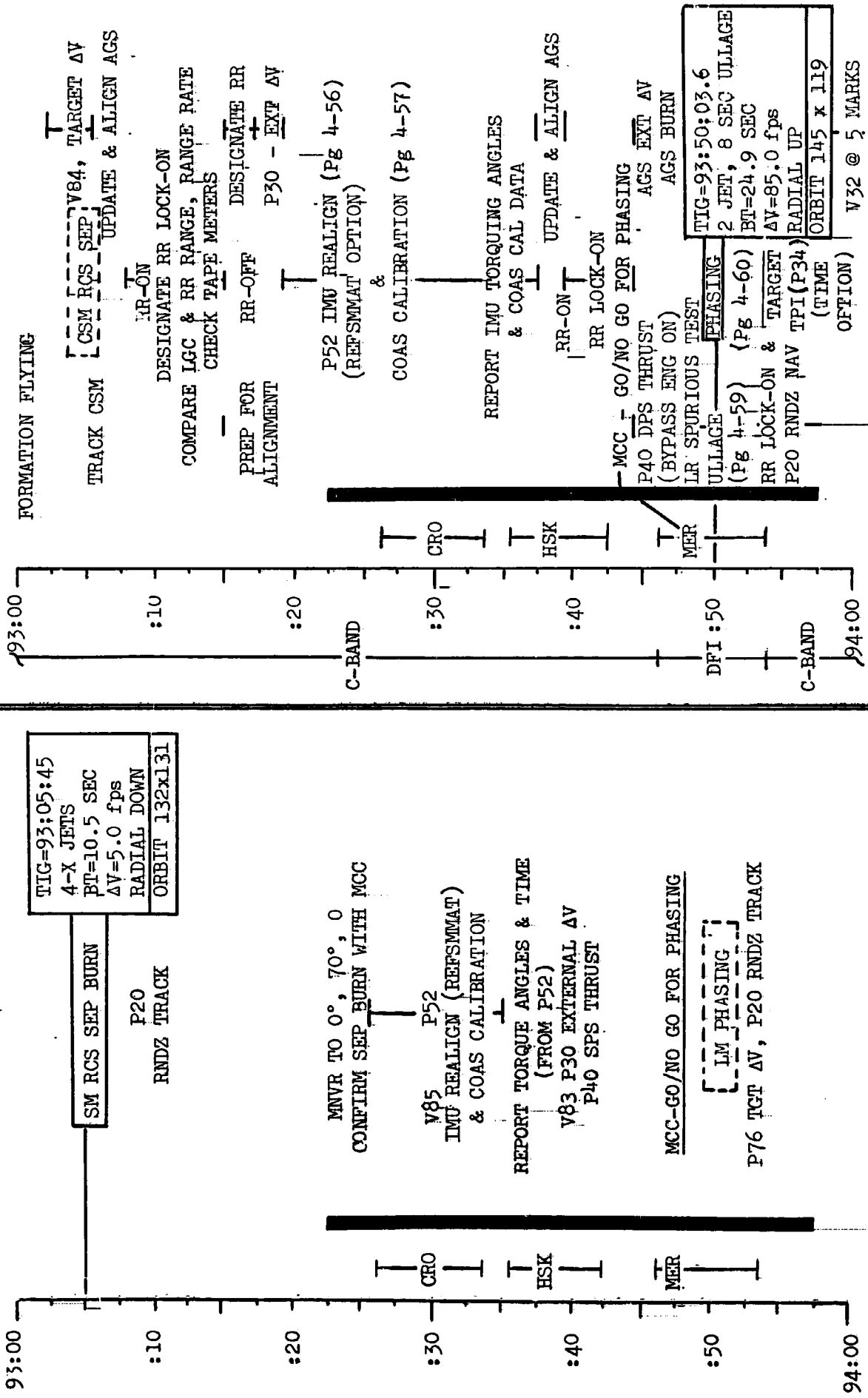

MISSION	EDITION	DATE	TIME	DAY/REV	PAGE
APOLLO 9	FINAL	FEBRUARY 3, 1969	93:00 - 94:00	5/59	3-62

**CSM**  
CMP

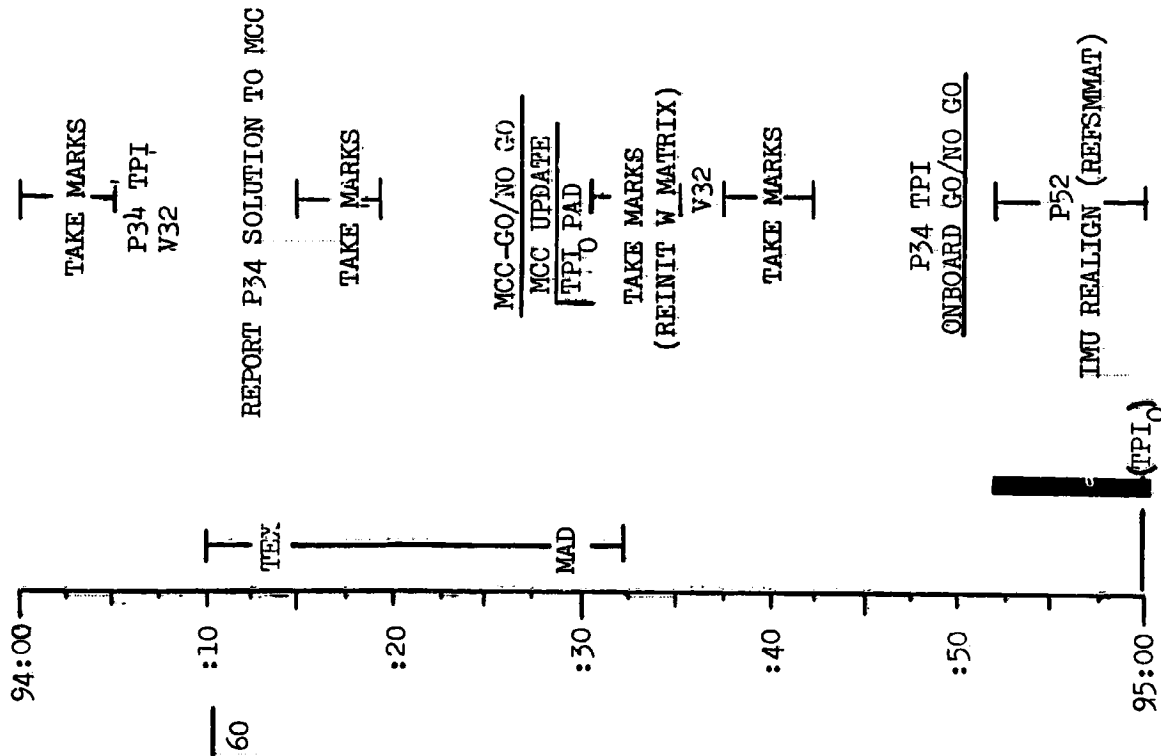

**FLIGHT PLAN**

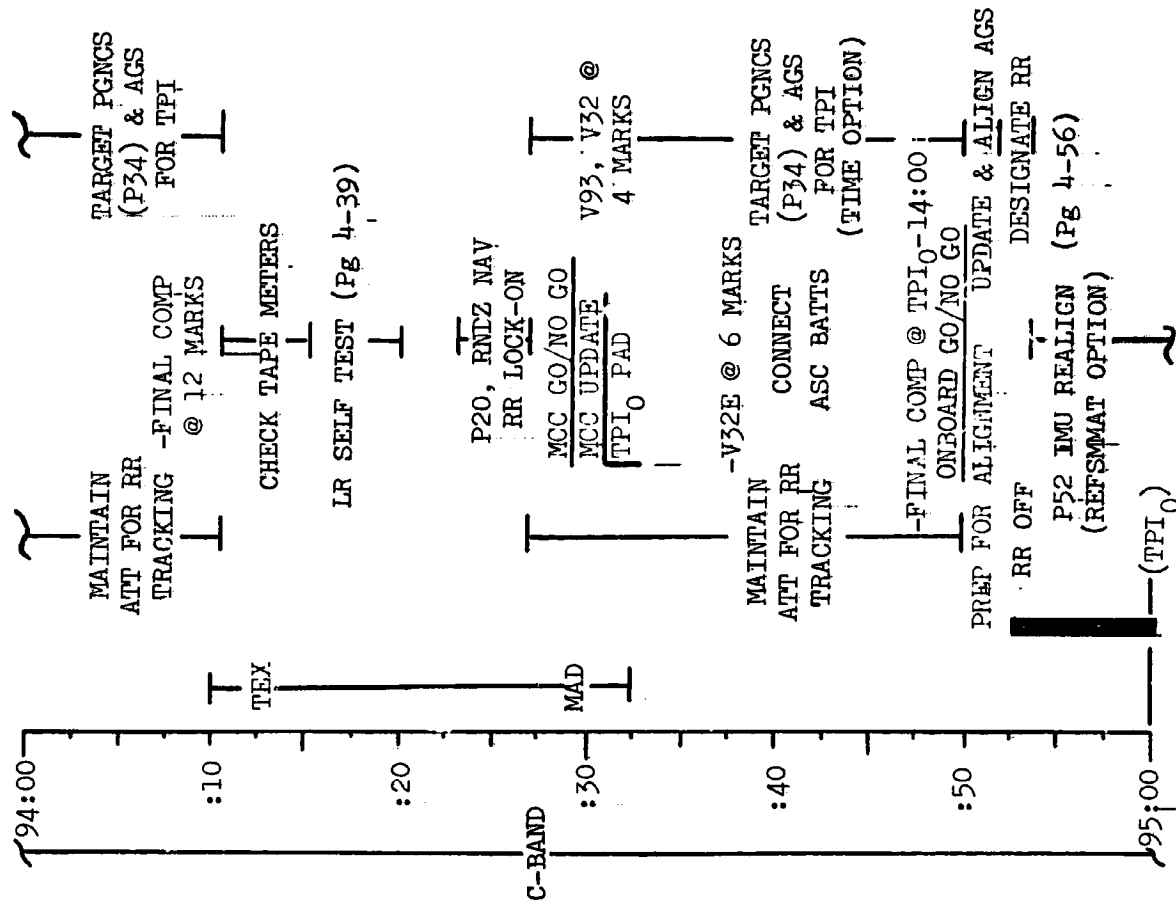

**IM**

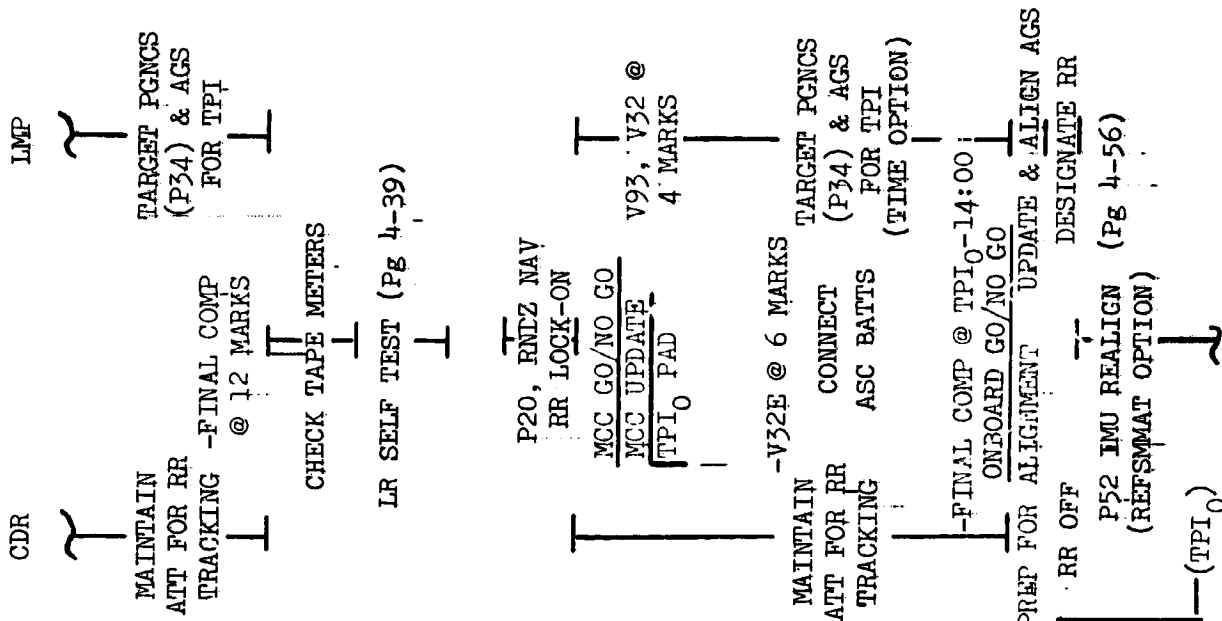

MISSION	EDITION	DATE	TIME	DAY/REV	PAGE
APOLLO 9	FINAL	FEBRUARY 3, 1969	94:00 - 95:00	5/59-60	3-63

# FLIGHT PLAN

CSM  
CMP

IM

LMP

CDR

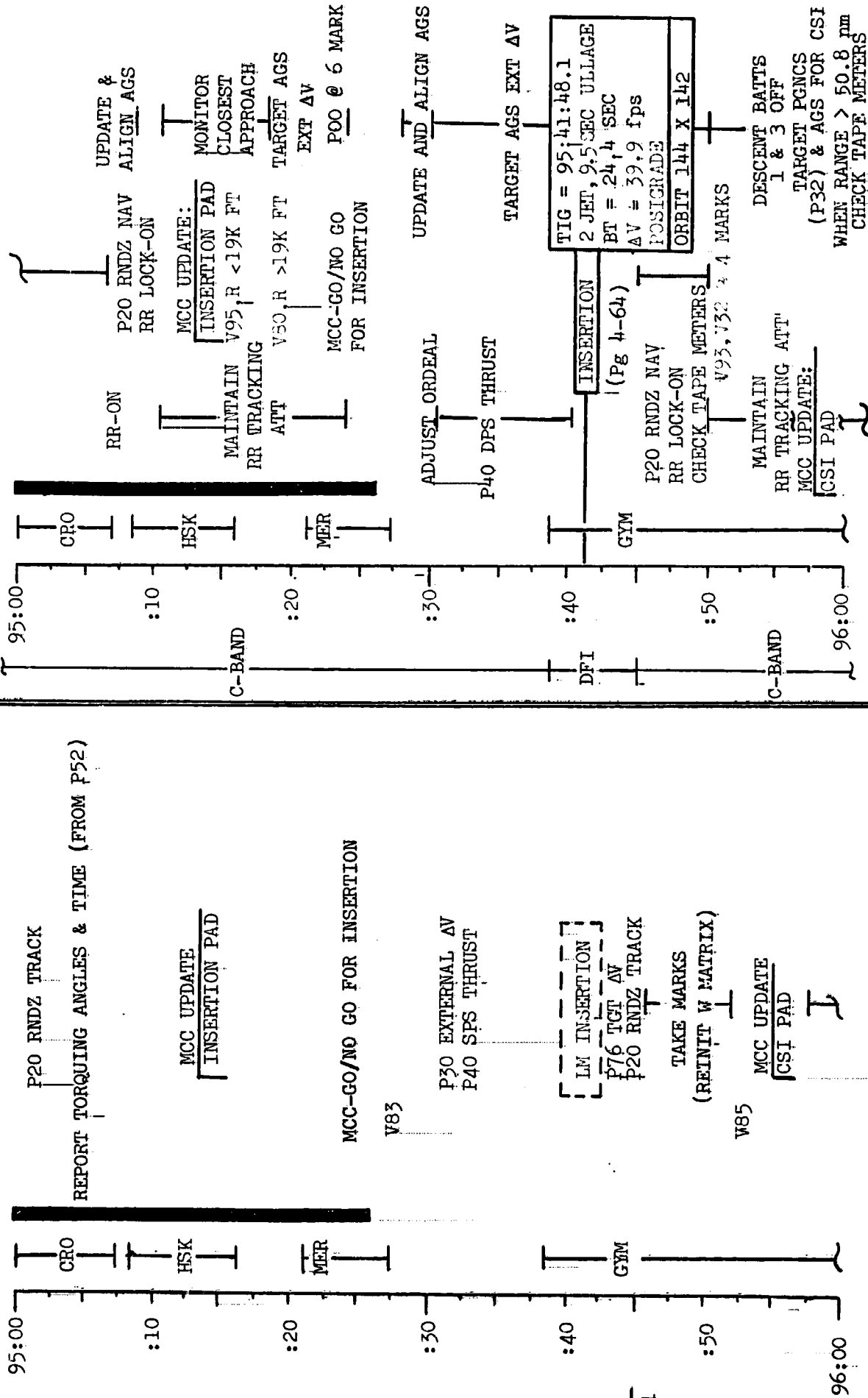

MISSION	EDITION	DATE	TIME	DAY/REV	PAGE
APOLLO 9	FINAL	FEBRUARY 3, 1969	95:00 - 96:00	5/60-61	3-64

# FLIGHT PLAN

CSM

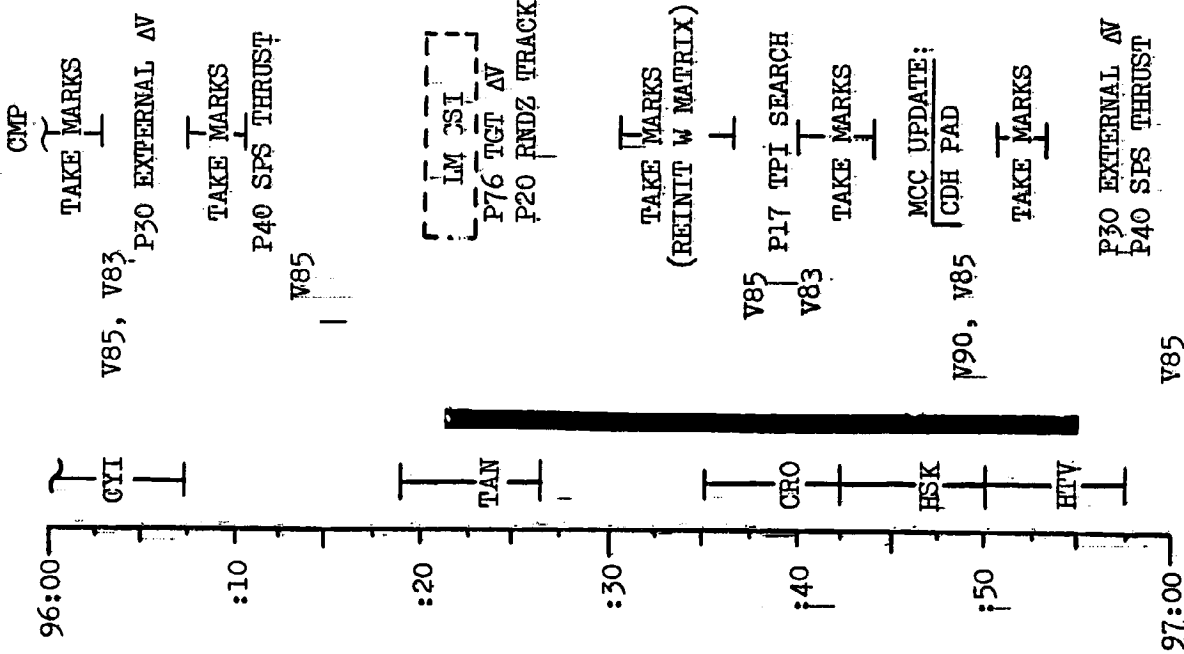

IM

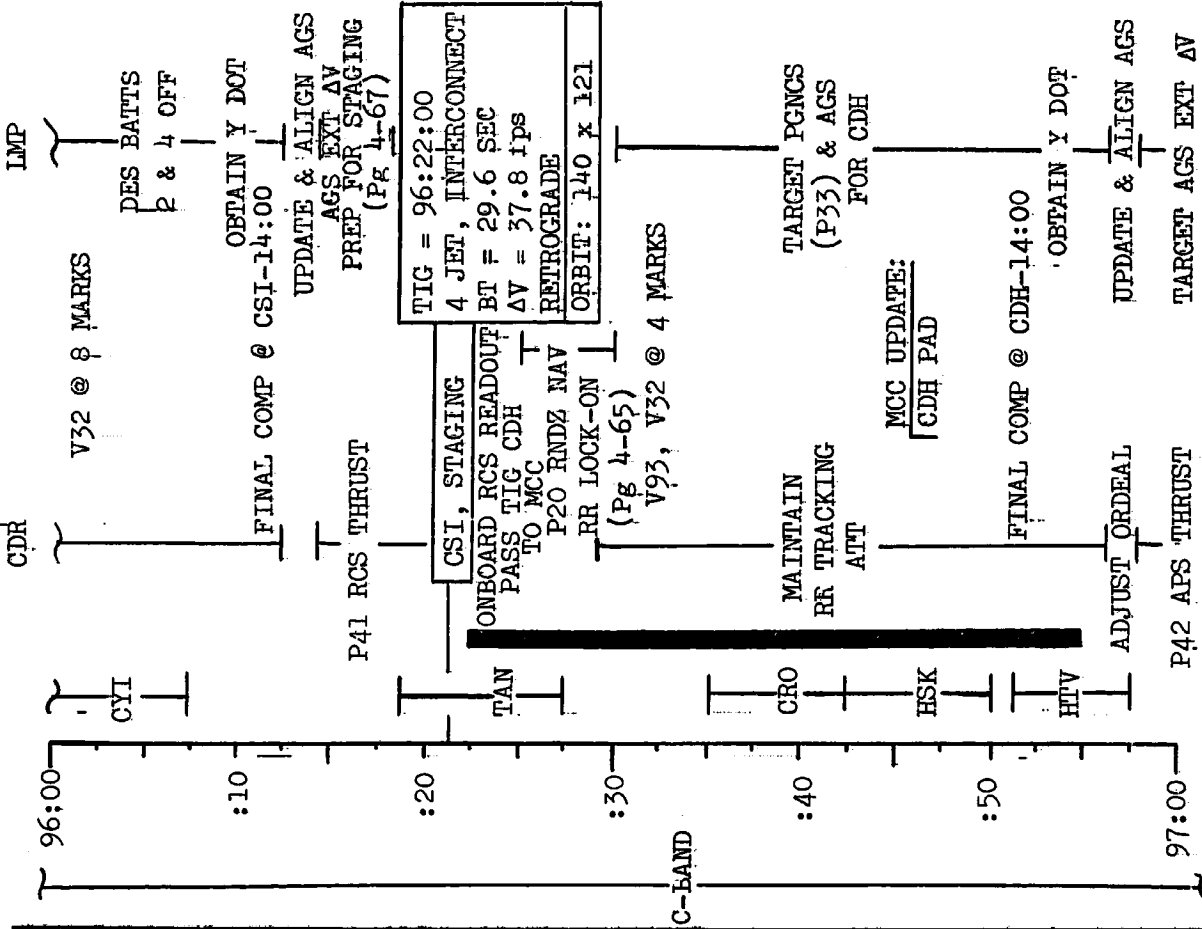

TIG = 96:22:00  
4 JET, INTERCONNECT  
BT = 29.6 SEC  
AV = 37.8 ips  
RETROGRADE  
ORBIT: 140 x 121

MISSION	EDITION	DATE	TIME	DAY/REV	PAGE
APOLLO 9	FINAL	FEBRUARY 3, 1969	96:00 - 97:00	5/61	3-65

CSM

FLIGHT PLAN

LM

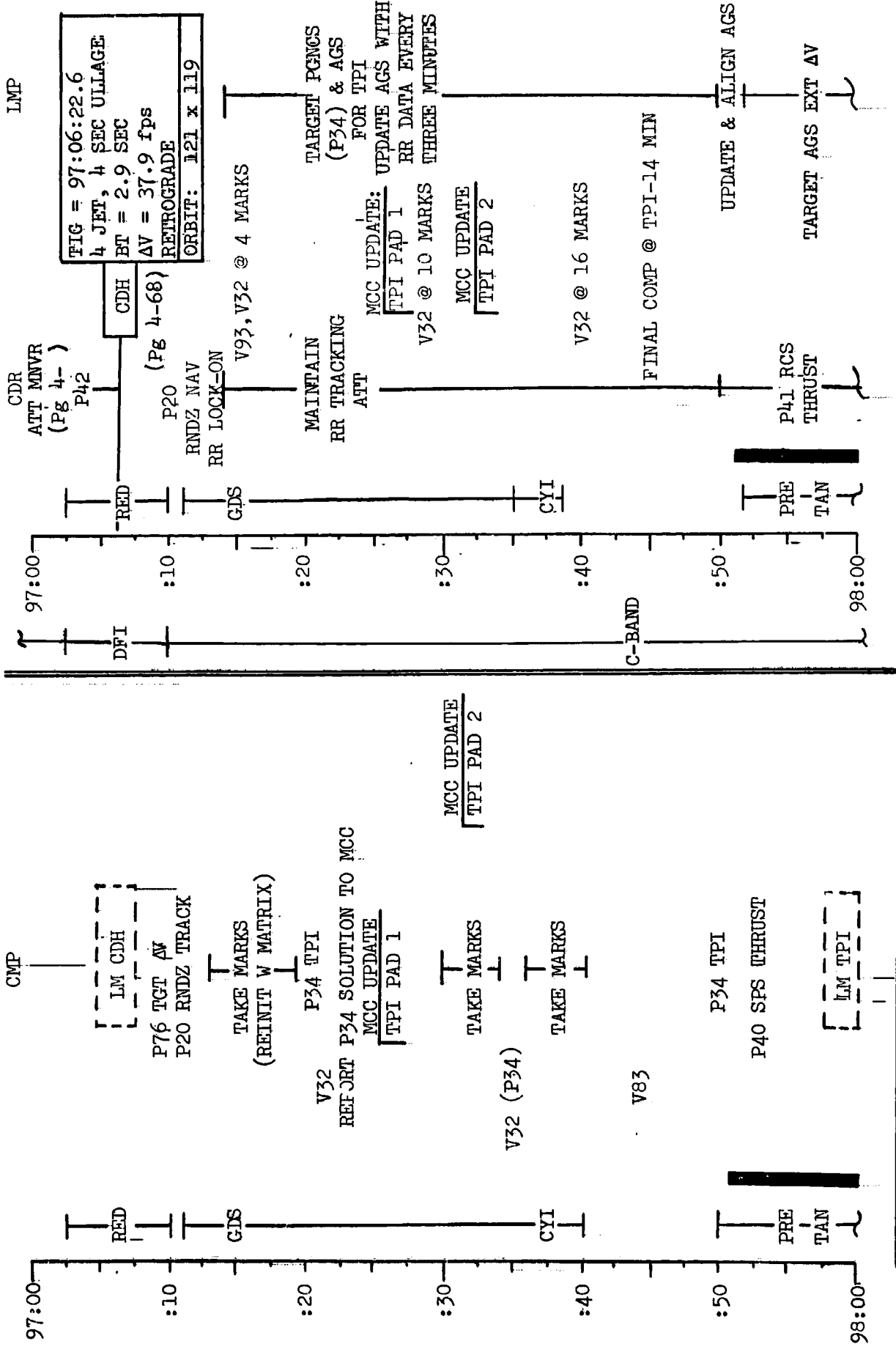

MISSION	EDITION	DATE	TIME	DAY/REV	PAGE
APOLLO 9	FINAL	FEBRUARY 3, 1969	97:00 - 98:00	5/61-62	3-66

# FLIGHT PLAN

CSM  
CMP

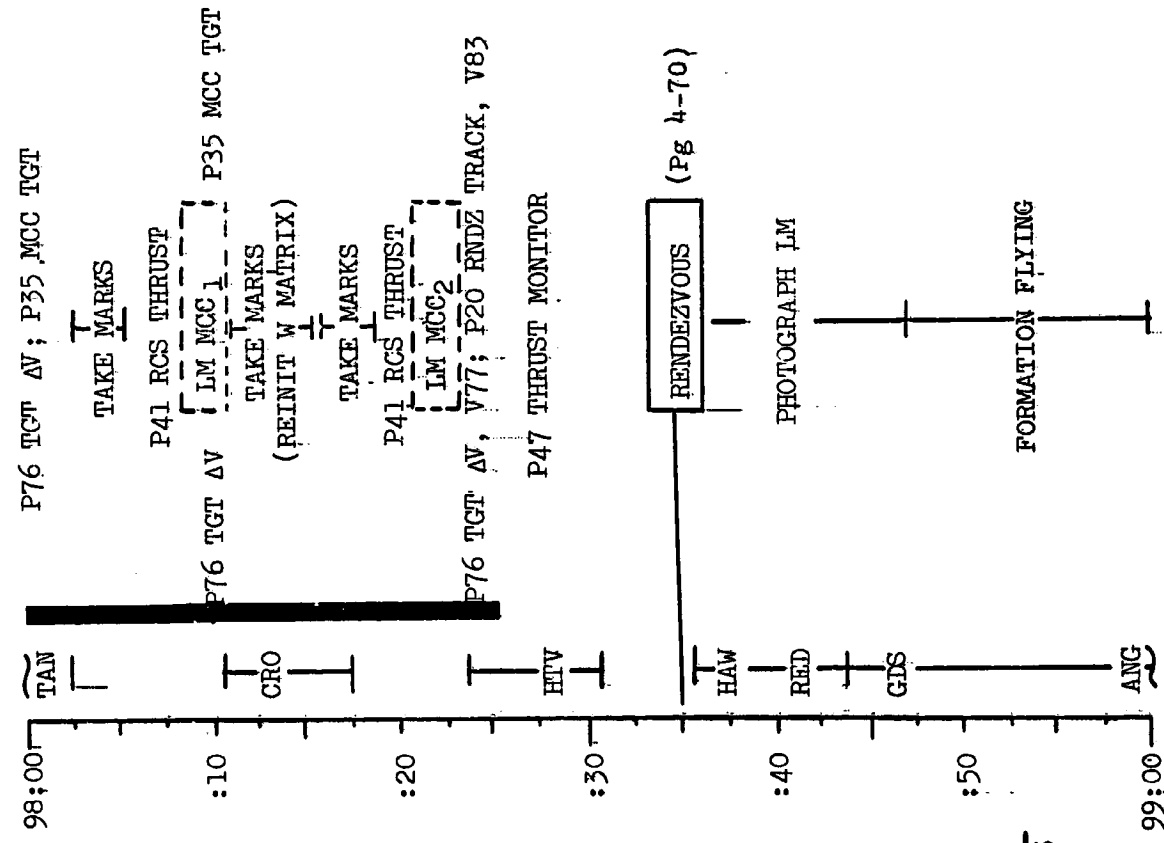

CDR  
LMP  
(Pg 4-69)

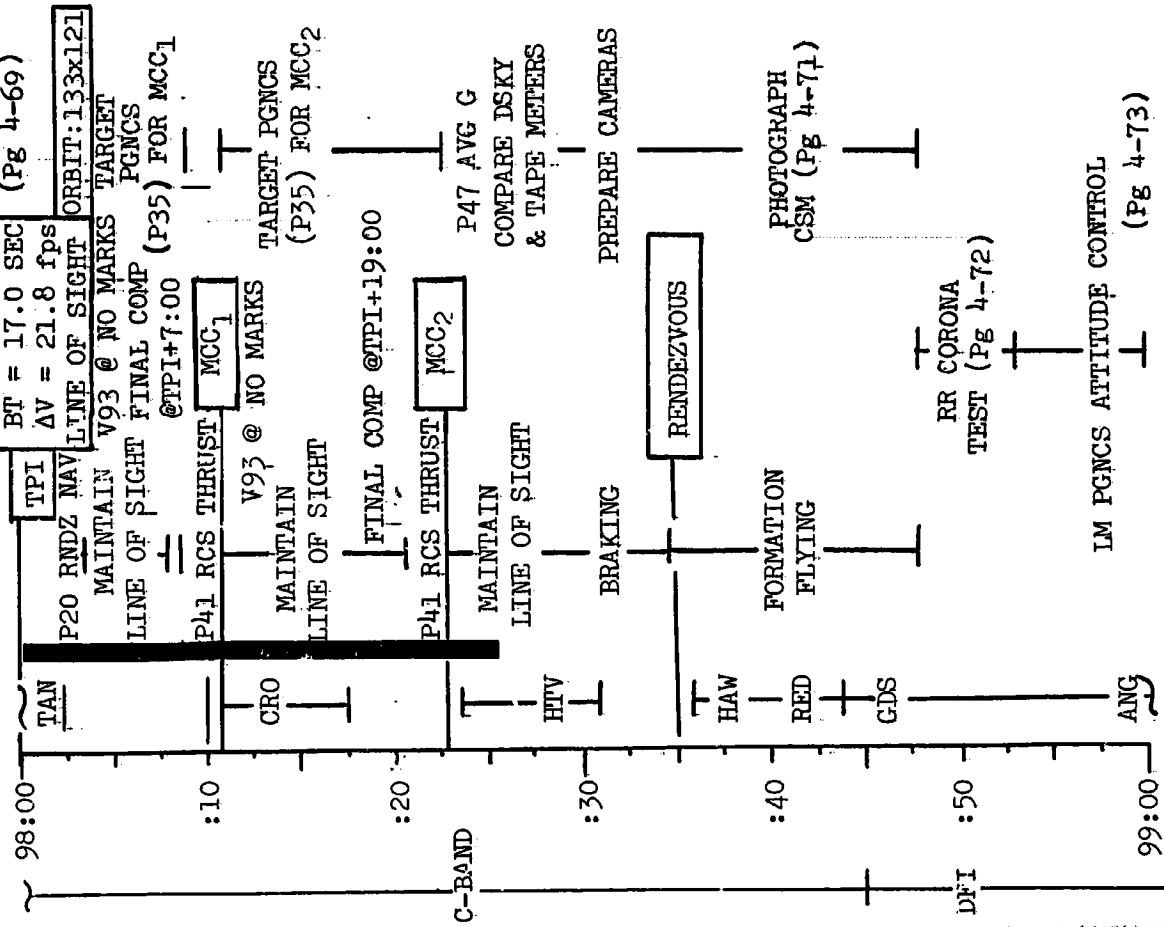

MISSION	EDITION	DATE	TIME	DAY/REV	PAGE
APOLLO 9	FINAL	FEBRUARY B, 1969	98:00 - 99:00	5/62-63	3-67

CSM

FLIGHT PLAN

IM

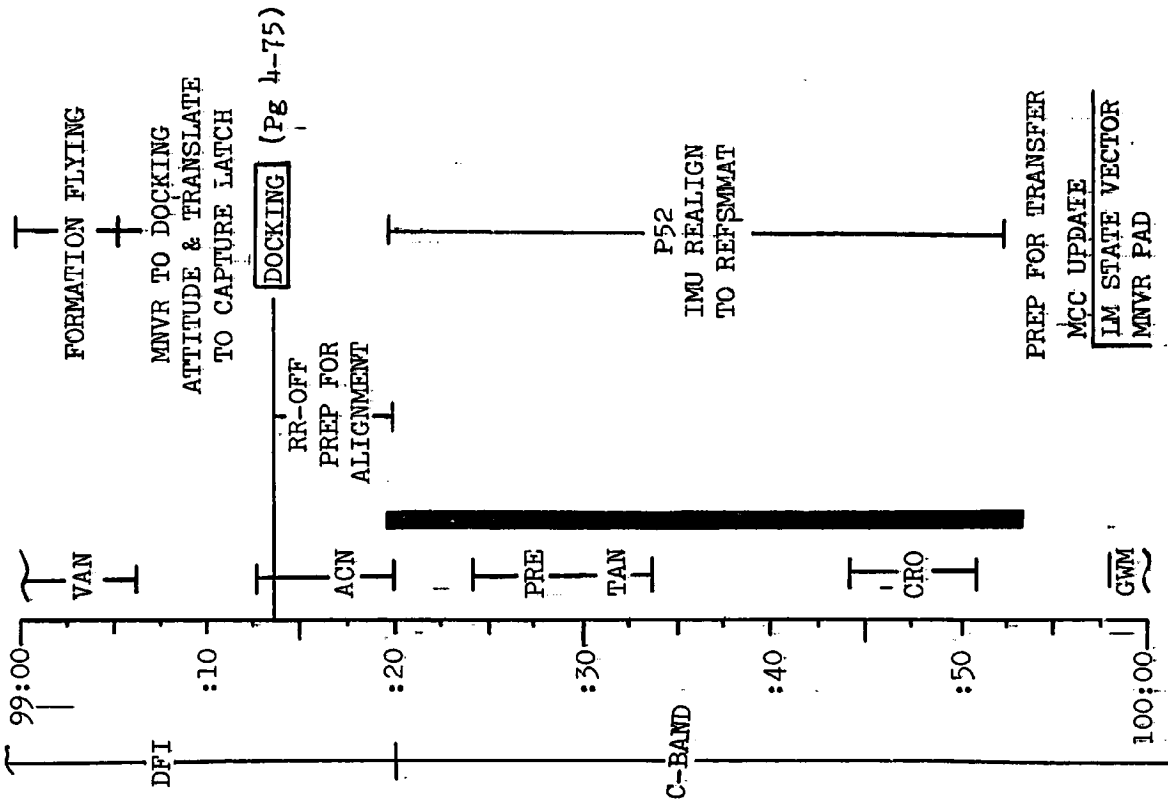
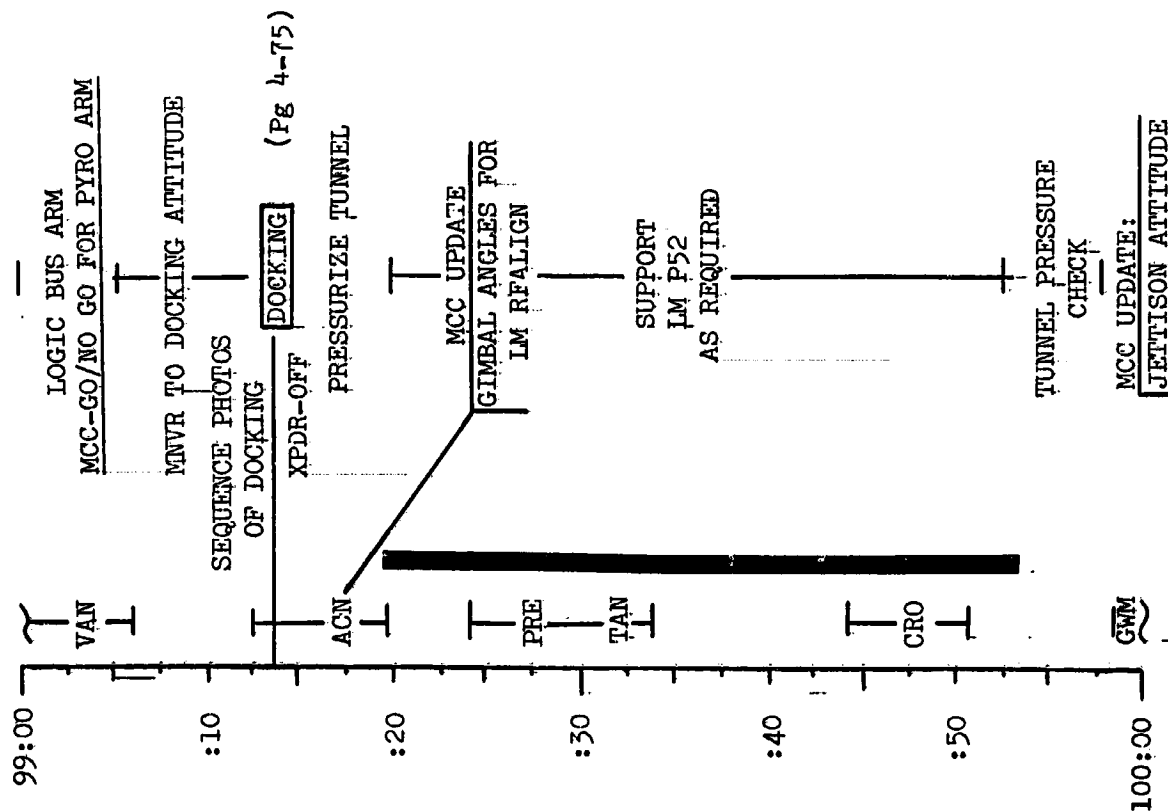

MISSION	EDITION	DATE	TIME	DAY/REV	PAGE
APOLLO 9	FINAL	FEBRUARY 3, 1969	99:00 - 100:00	5/63	3-68

# FLIGHT PLAN

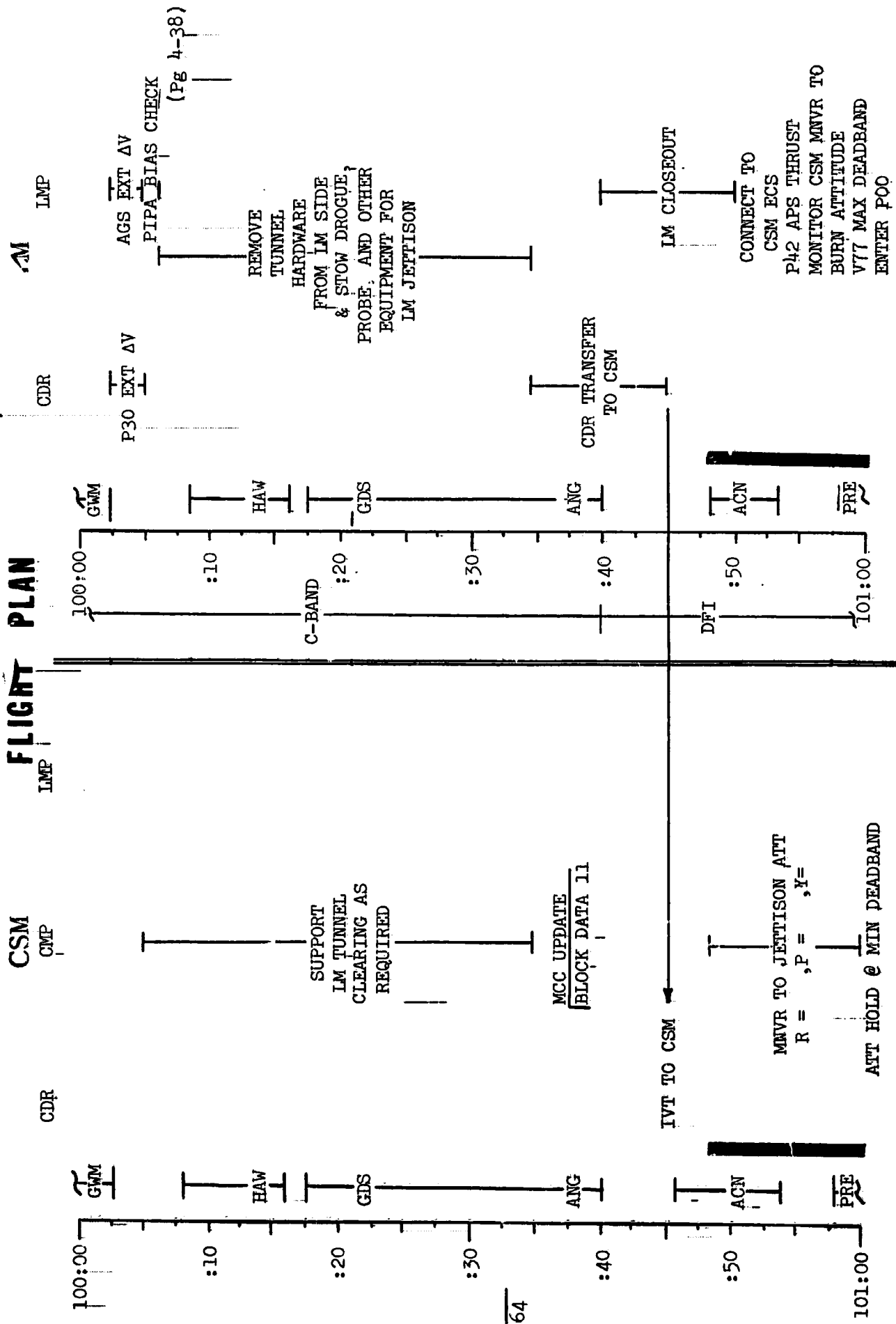

MISSION	EDITION	DATE	TIME	DAY/REV	PAGE
APOLLO 9	FINAL	FEBRUARY 3, 1969	100:00 - 101:00	5 / 63-64	3-69



# FLIGHT PLAN

# LM

# CSM

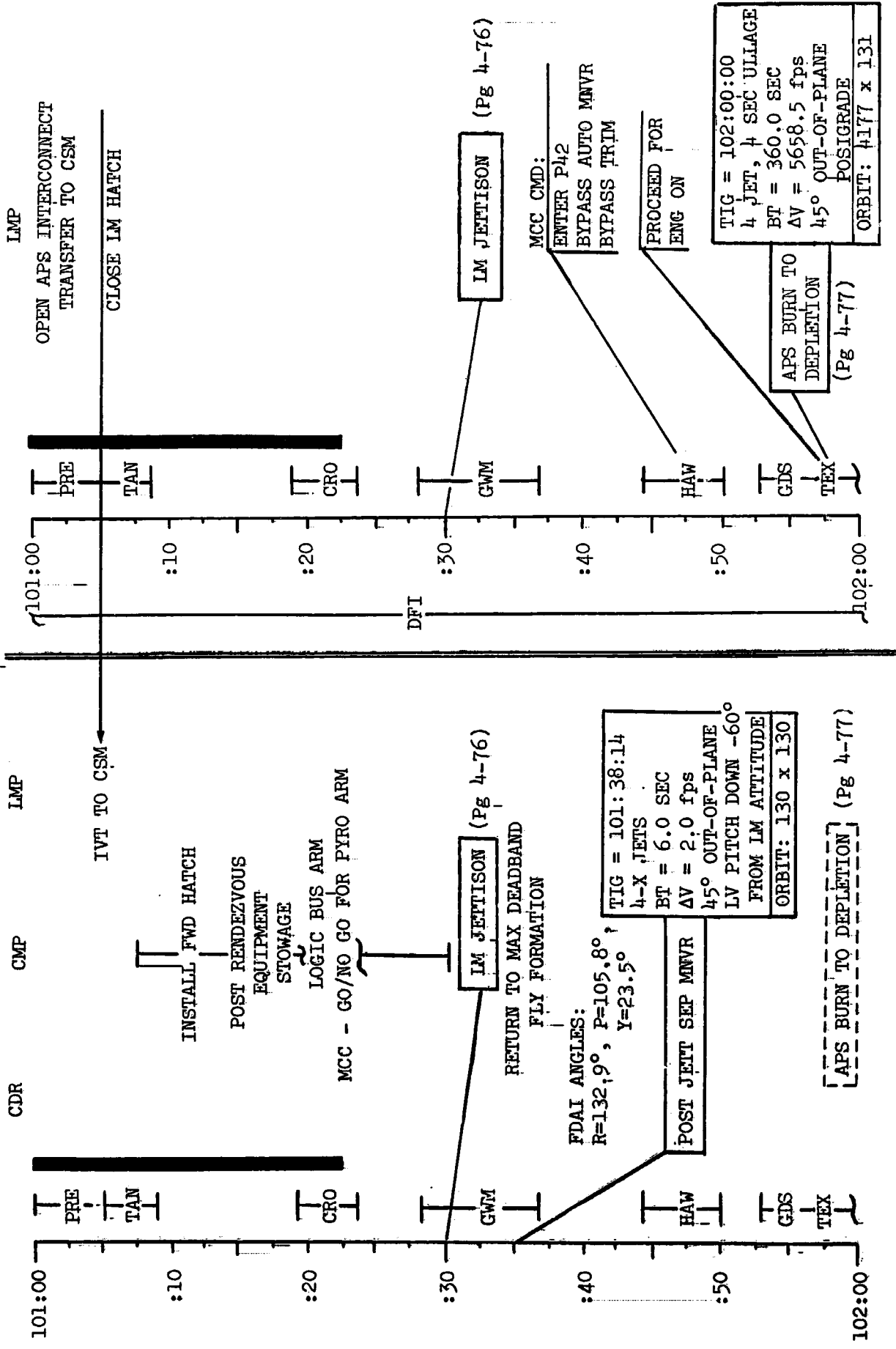

MISSION	EDITION	DATE	TIME	DAY/REV	PAGE
APOLLO 9	FINAL	FEBRUARY 3, 1969	101:00 - 102:00	5/64	3-70

# FLIGHT PLAN

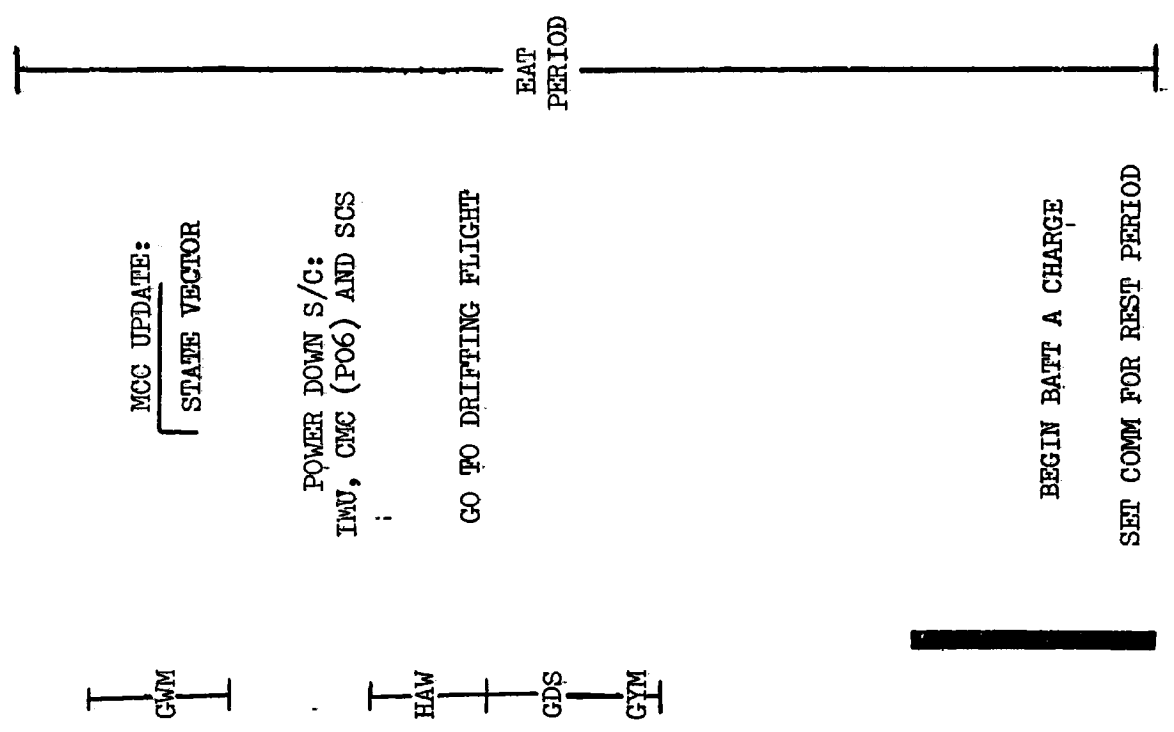
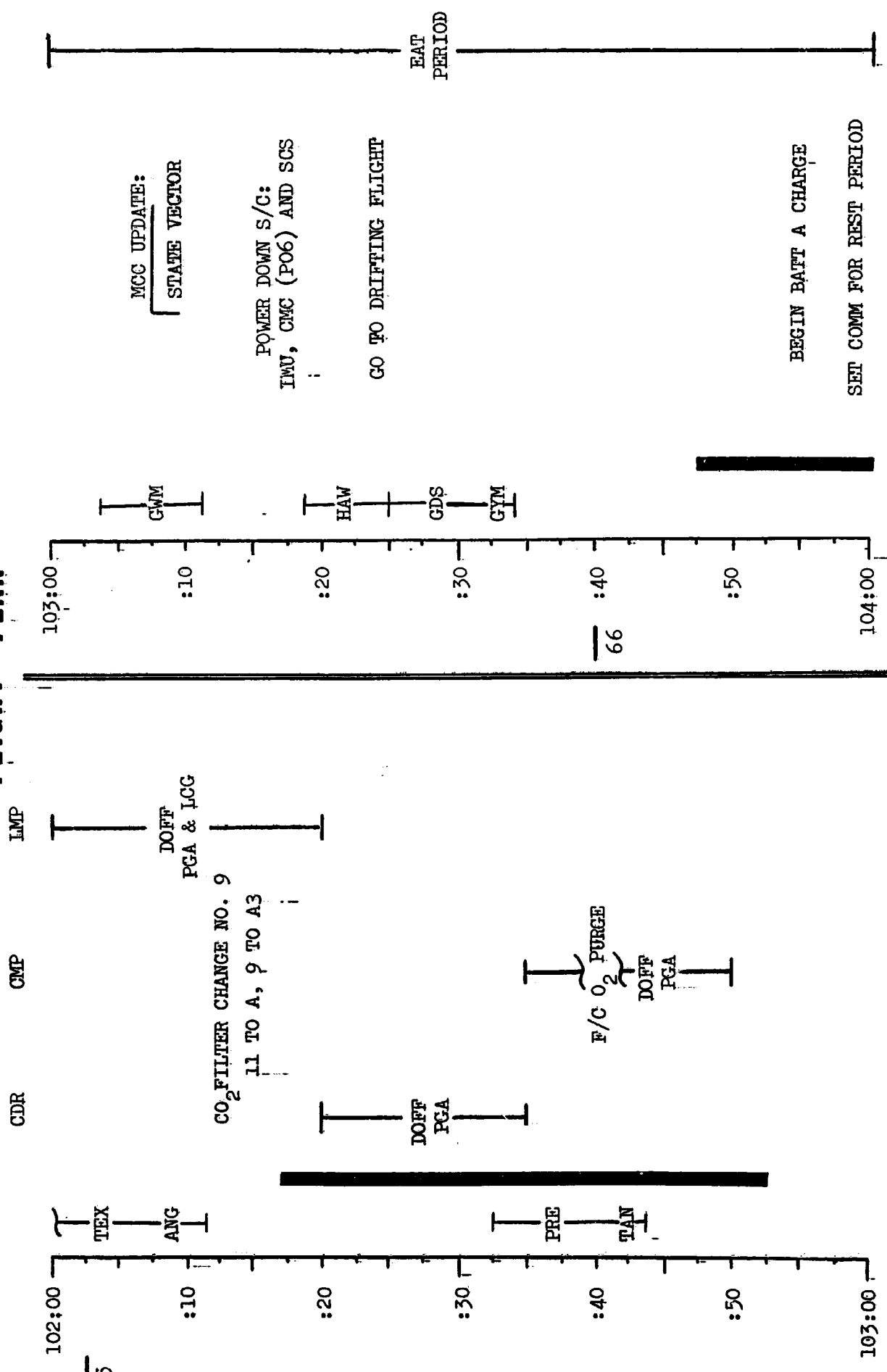

MISSION	EDITION	DATE	TIME	DAY/REV	PAGE
APOLLO 9	FINAL	FEBRUARY 3, 1969	102:00 - 104:00	5/64-66	3-71

# FLIGHT PLAN

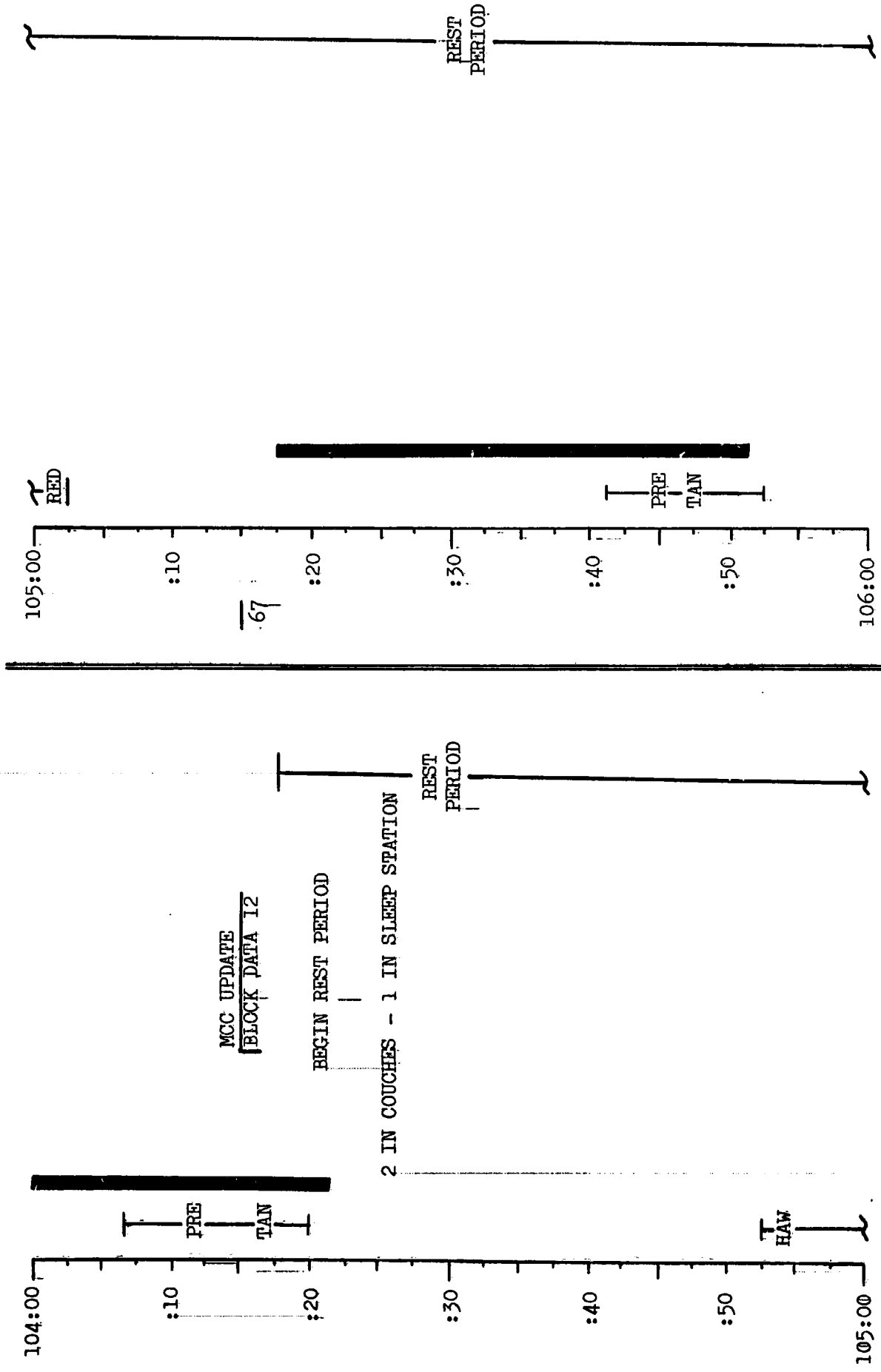

MISSION	EDITION	DATE	TIME	DAY/REV	PAGE
APOLLO 9	FINAL	FEBRUARY 3, 1969	104:00 - 106:00	5/66-67	3-72

# FLIGHT PLAN

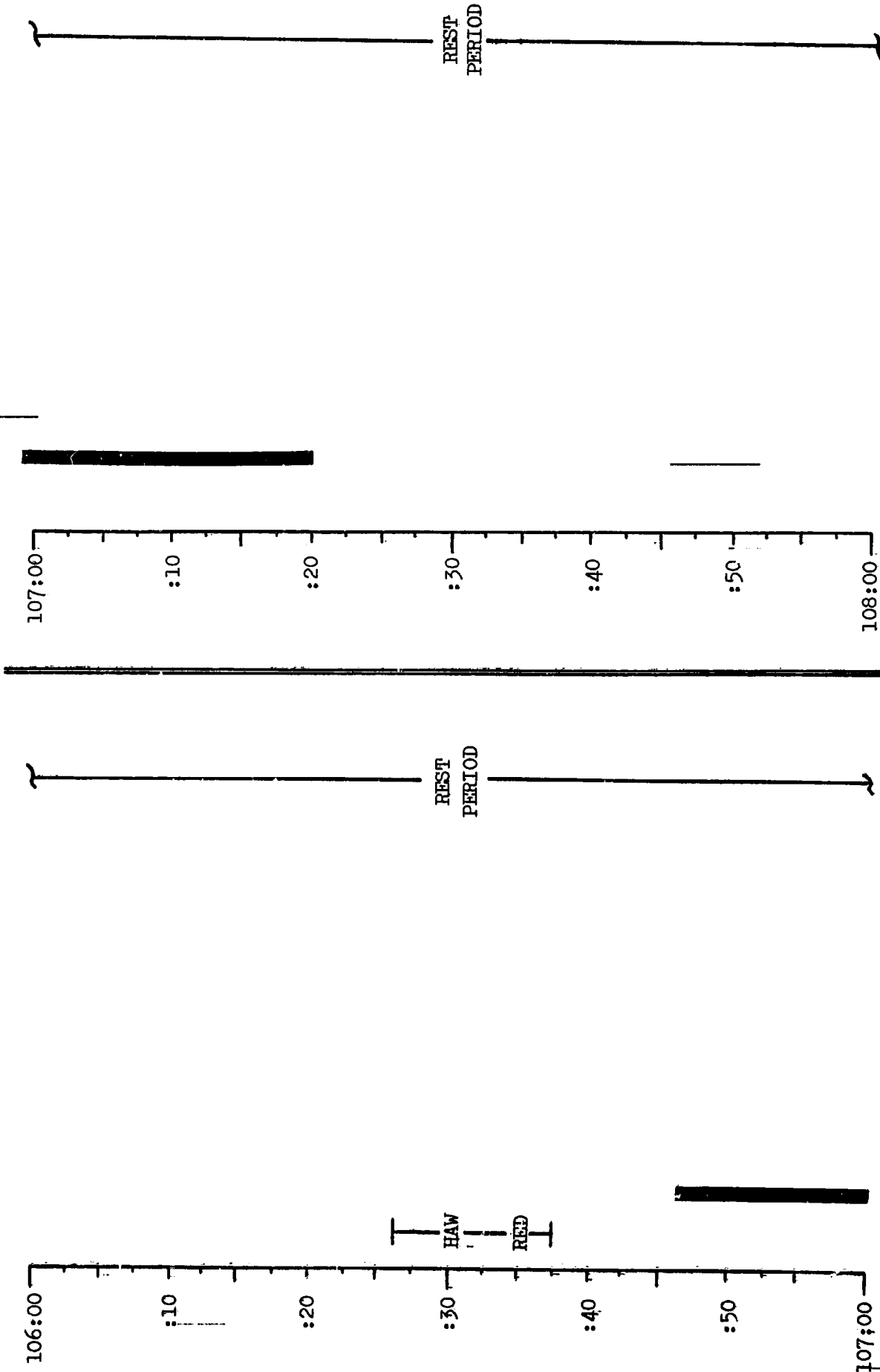

MISSION	EDITION	DATE	TIME	DAY/REV	PAGE
APOLLO 9	FINAL	FEBRUARY 3, 1969	106:00 - 108:00	5/67-68	3-73

# FLIGHT PLAN

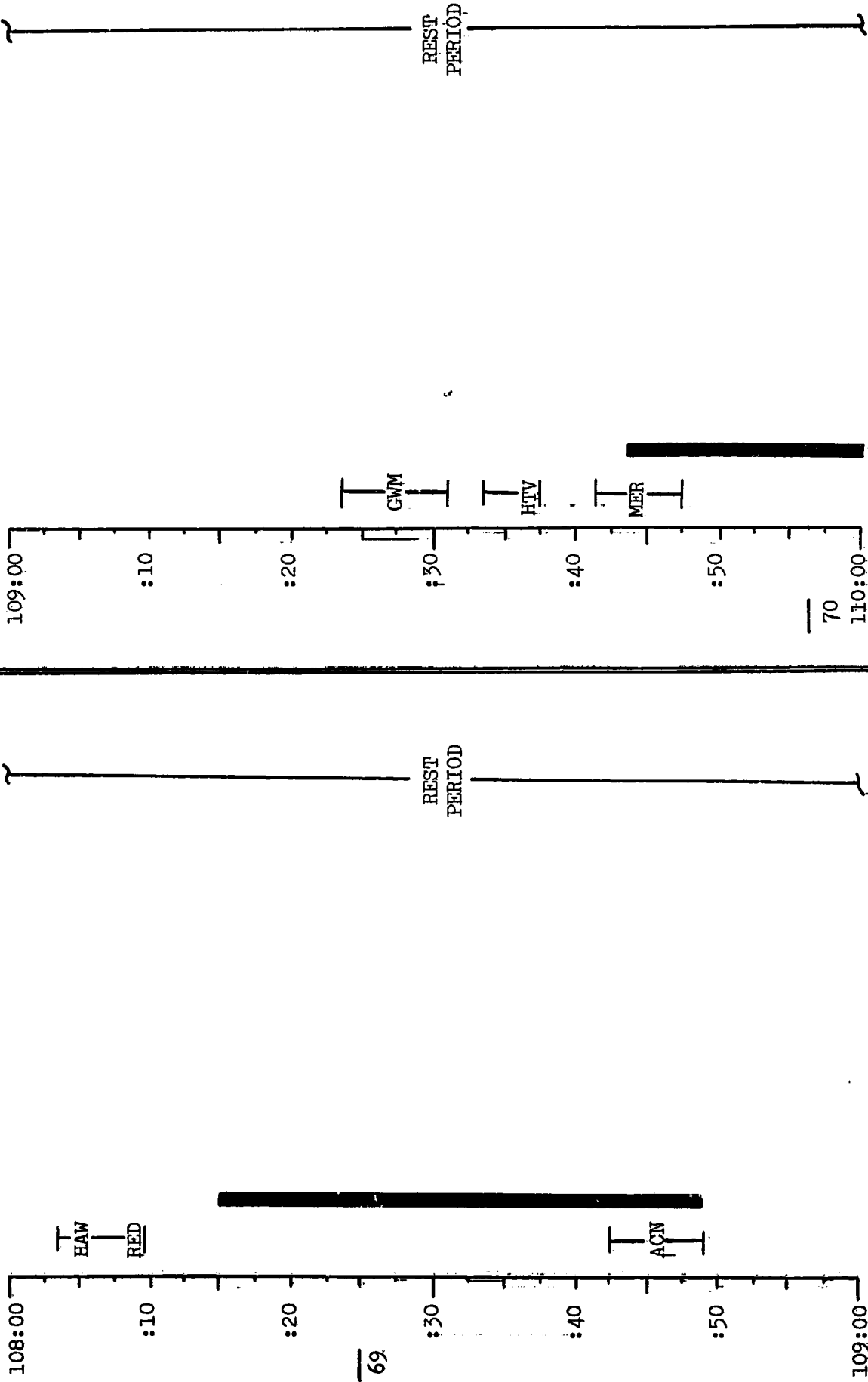

MISSION	EDITION	DATE	TIME	DAY/REV	PAGE
APOLLO 9	FINAL	FEBRUARY 3, 1969	108:00-110:00	5/68-70	3-74

# FLIGHT PLAN

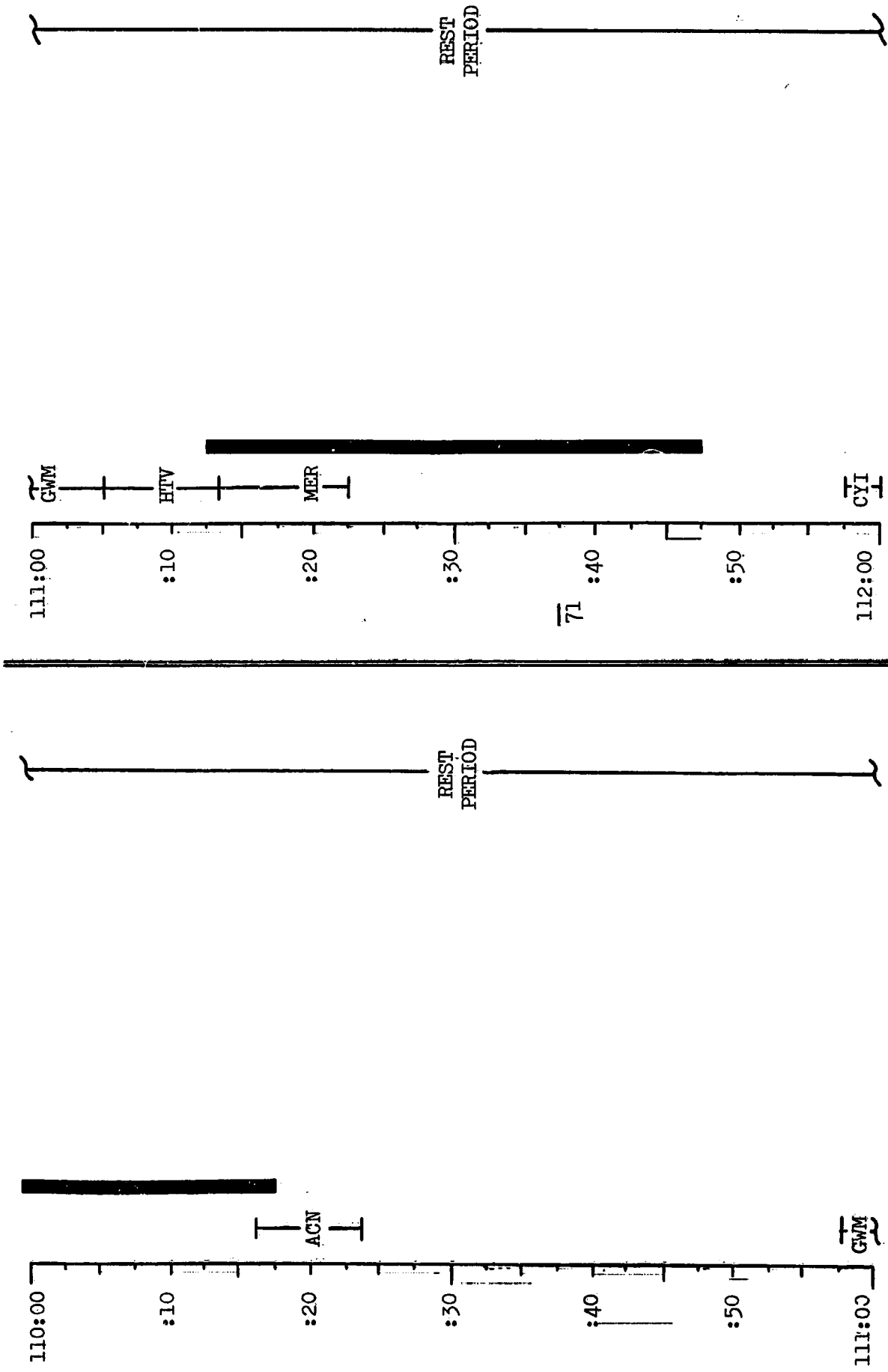

MISSION	EDITION	DATE	TIME	DAY/REV	PAGE
APOLLO 9	FINAL	FEBRUARY 3, 1969	110:00 - 112:00	5/70-71	3-75

# FLIGHT PLAN

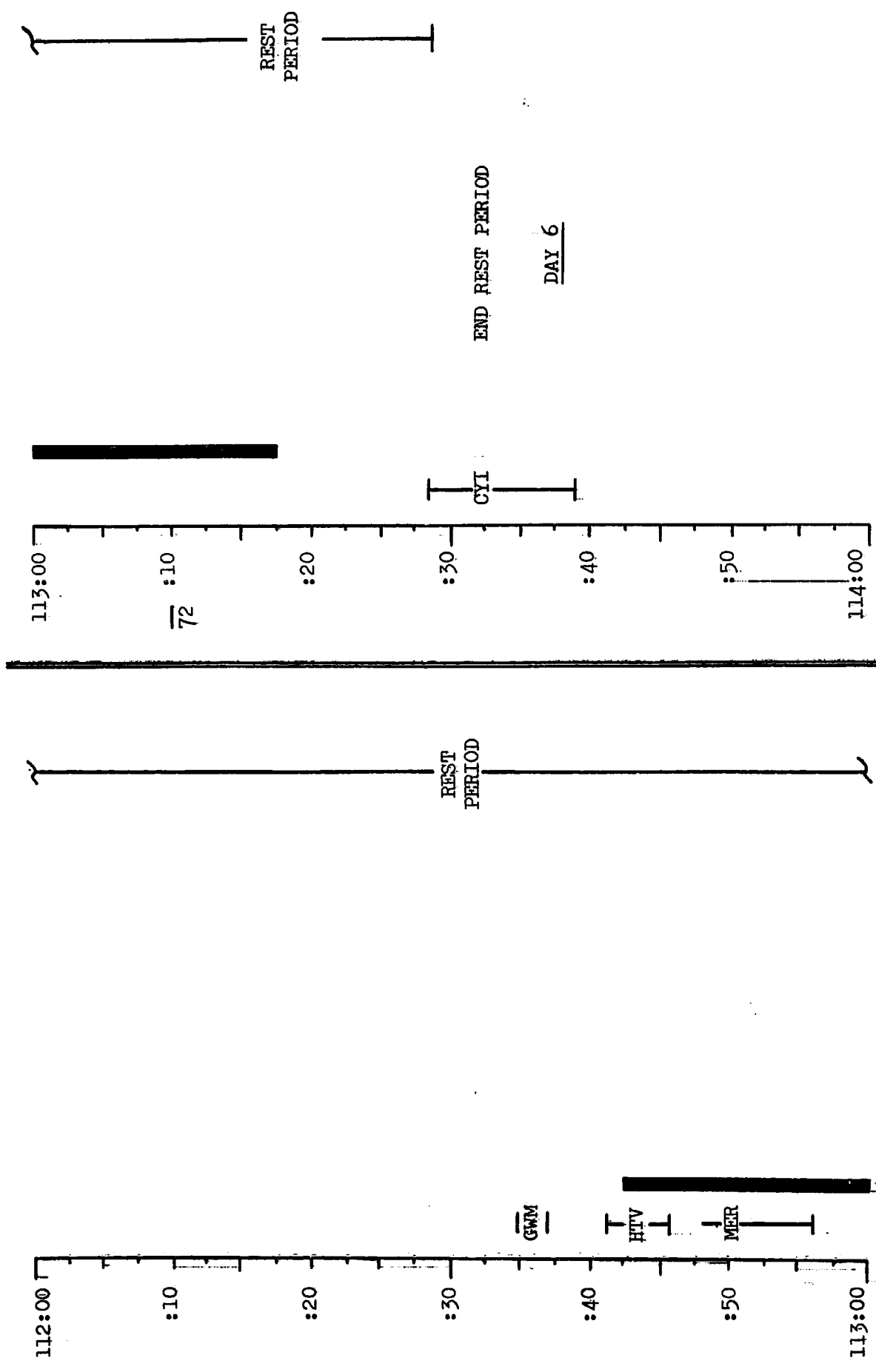

DAY 6

MISSION	EDITION	DATE	TIME	DAY/REV	PAGE
APOLLO 9	FINAL	FEBRUARY 3, 1969	112:00 - 114:00	5-6/71-72	3-76

# FLIGHT PLAN

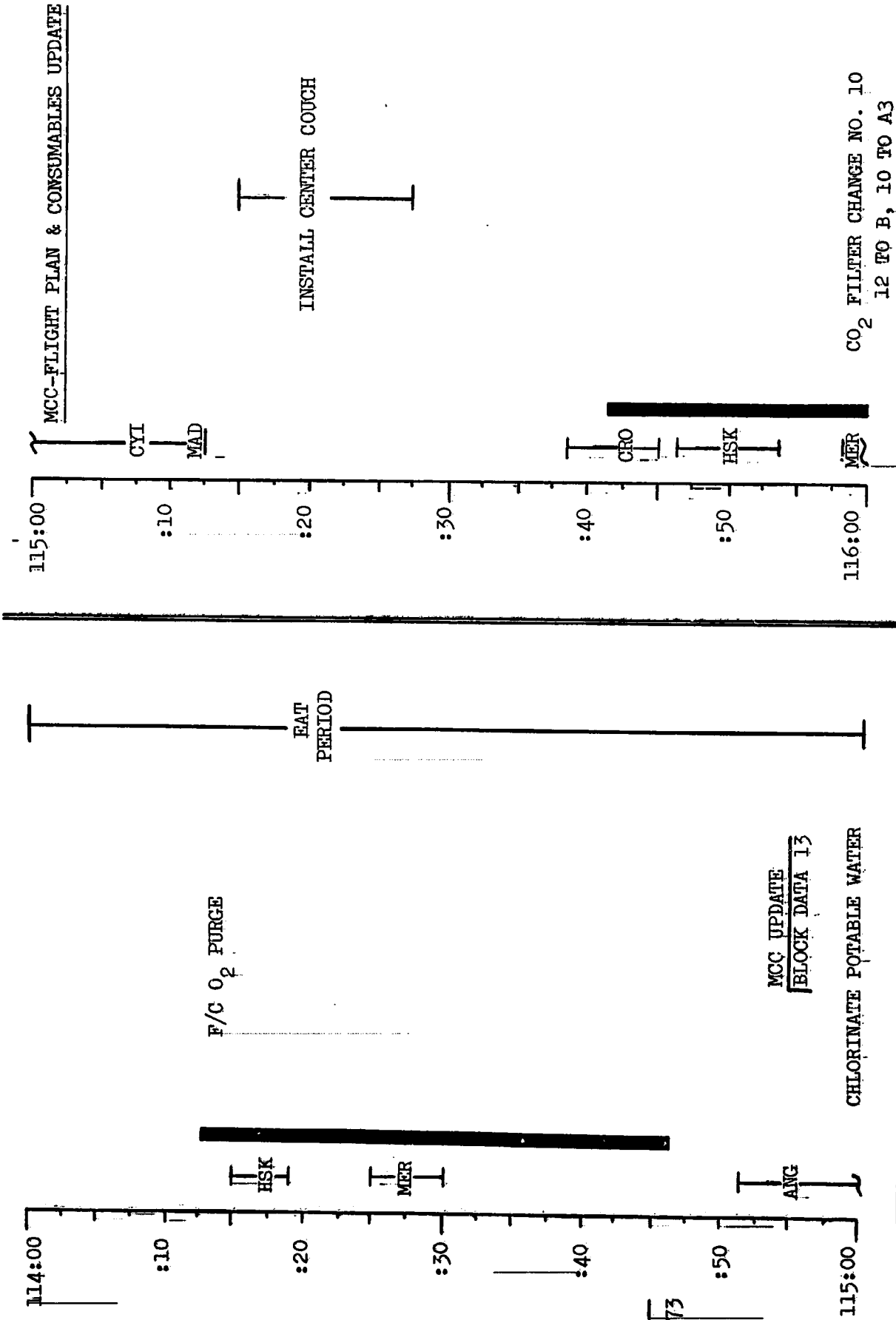

MISSION	EDITION	DATE	TIME	DAY/REV	PAGE
APOLLO 9	FINAL	FEBRUARY 3, 1969	114:00 - 116:00	6/72-73	3-77



# FLIGHT PLAN

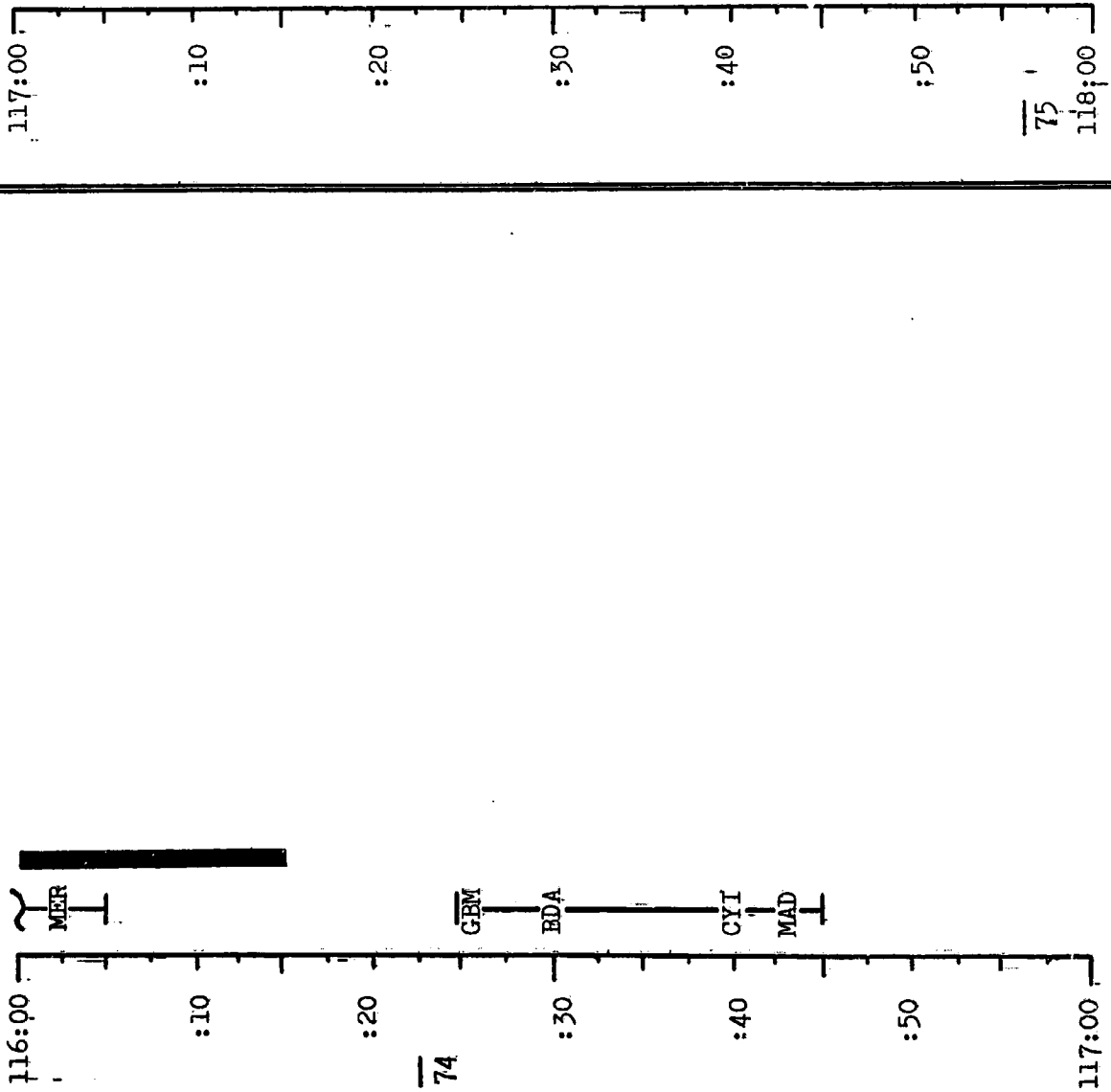

S/C POWER UP:  
IMU, CMC, AND SCS

MISSION	EDITION	DATE	TIME	DAY/REV	PAGE
APOLLO 9	FINAL	FEBRUARY 3, 1969	116:00 - 118:00	6/73-75	3-78

# FLIGHT PLAN

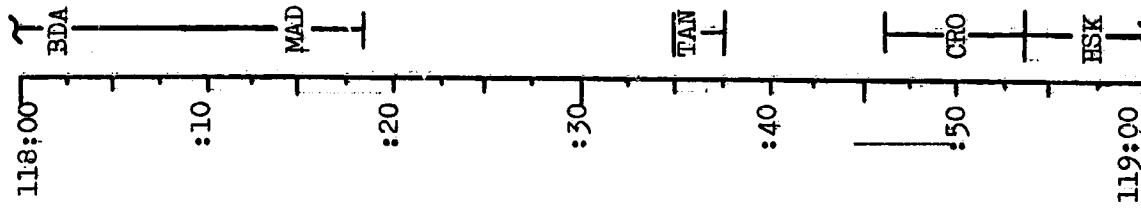

CMP ENTER LEB

DAMP RATES

P51  
IMU ORIENTATION

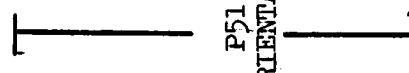

MCC-GO/NO GO FOR 93-1

MCC UPDATE  
STATE VECTOR  
TCF LOAD  
MWVR PAD

P30 EXTERNAL AV  
P40 SPS THRUST

MISSION	EDITION	DATE	TIME	DAY/REV	PAGE
APOLLO 9	FINAL	FEBRUARY 3, 1969	118:00 - 120:00	6/75-76	3-79

# FLIGHT PLAN

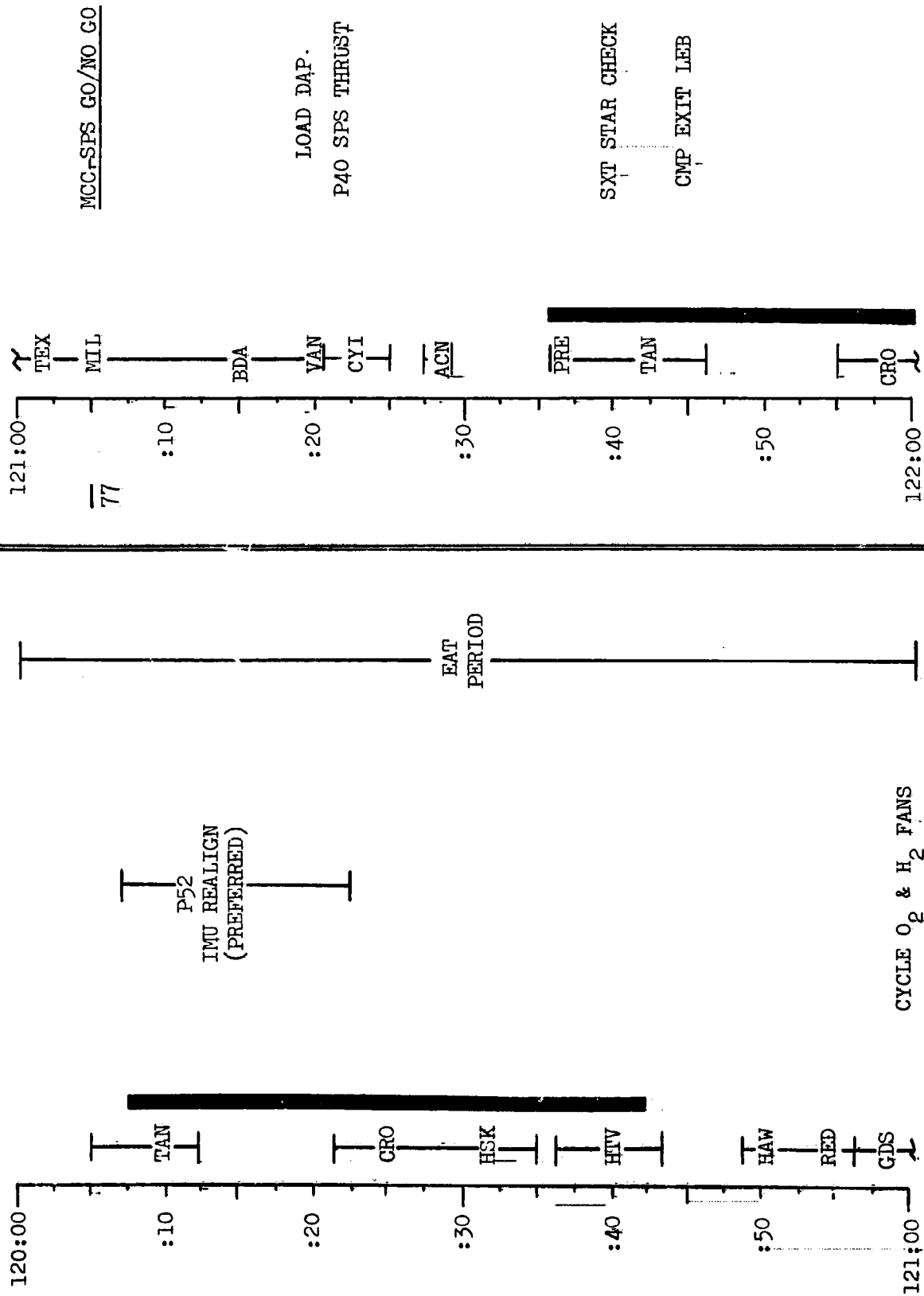

MISSION	EDITION	DATE	TIME	DAY/REV	PAGE
APOLLO 9	FINAL	FEBRUARY 3, 1969	120:00 - 122:00	6/76-77	3-80

# FLIGHT PLAN

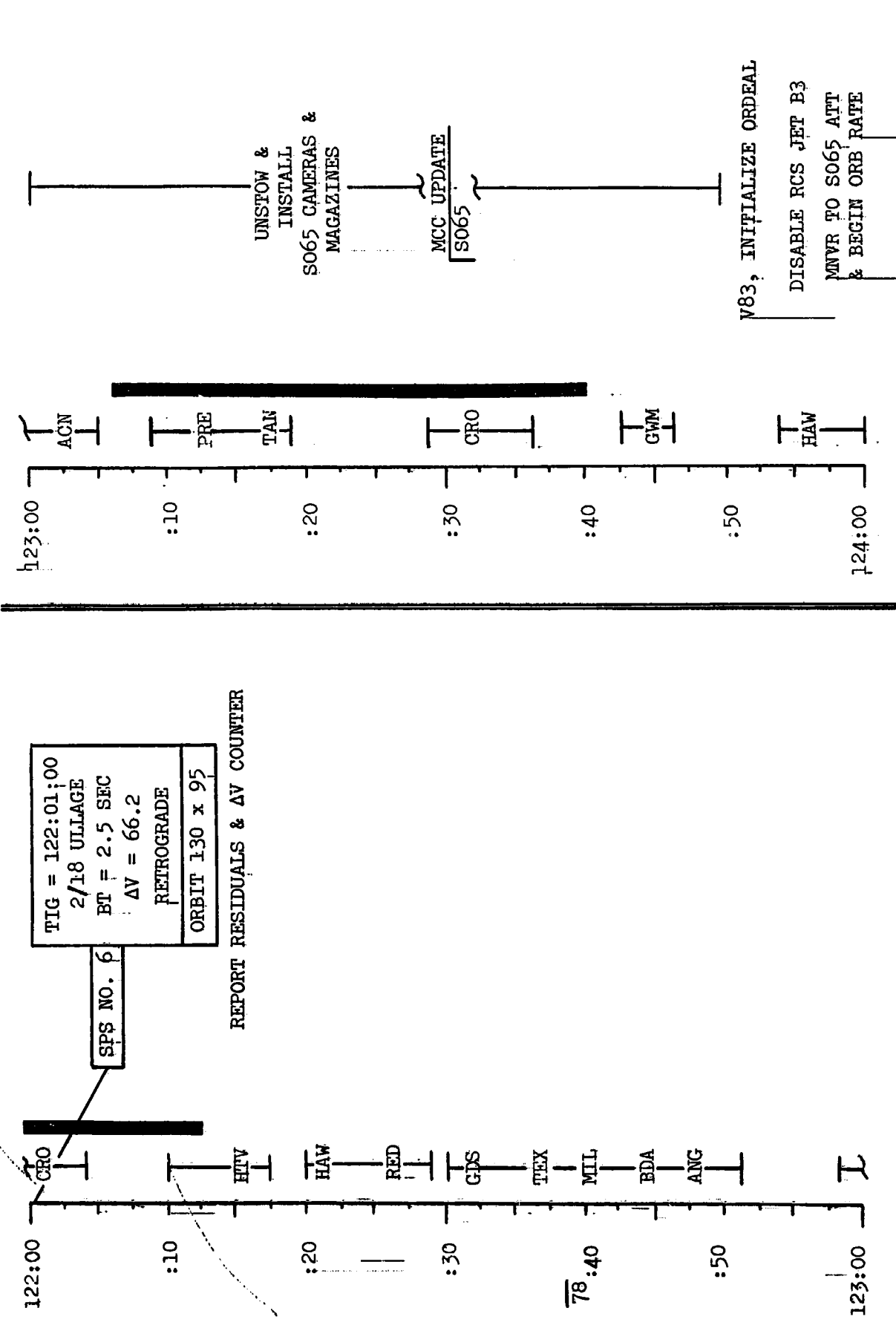

FIG = 122:01:00  
 2/18 ULLAGE  
 BT = 2.5 SEC  
 ΔV = 66.2  
 RETROGRADE  
 ORBIT 130 x 95

SPS NO. 6

UNSTOW &  
 INSTALL  
 S065 CAMERAS &  
 MAGAZINES

MCC UPDATE  
 S065

W83, INITIALIZE ORDEAL

DISABLE RCS JET B3

MNR TO S065 ATT  
 & BEGIN ORB RATE

MISSION	EDITION	DATE	TIME	DAY/REV	PAGE
APOLLO 9	FINAL	FEBRUARY 3, 1969	122:00 - 124:00	6/77-78	3-81

# FLIGHT PLAN

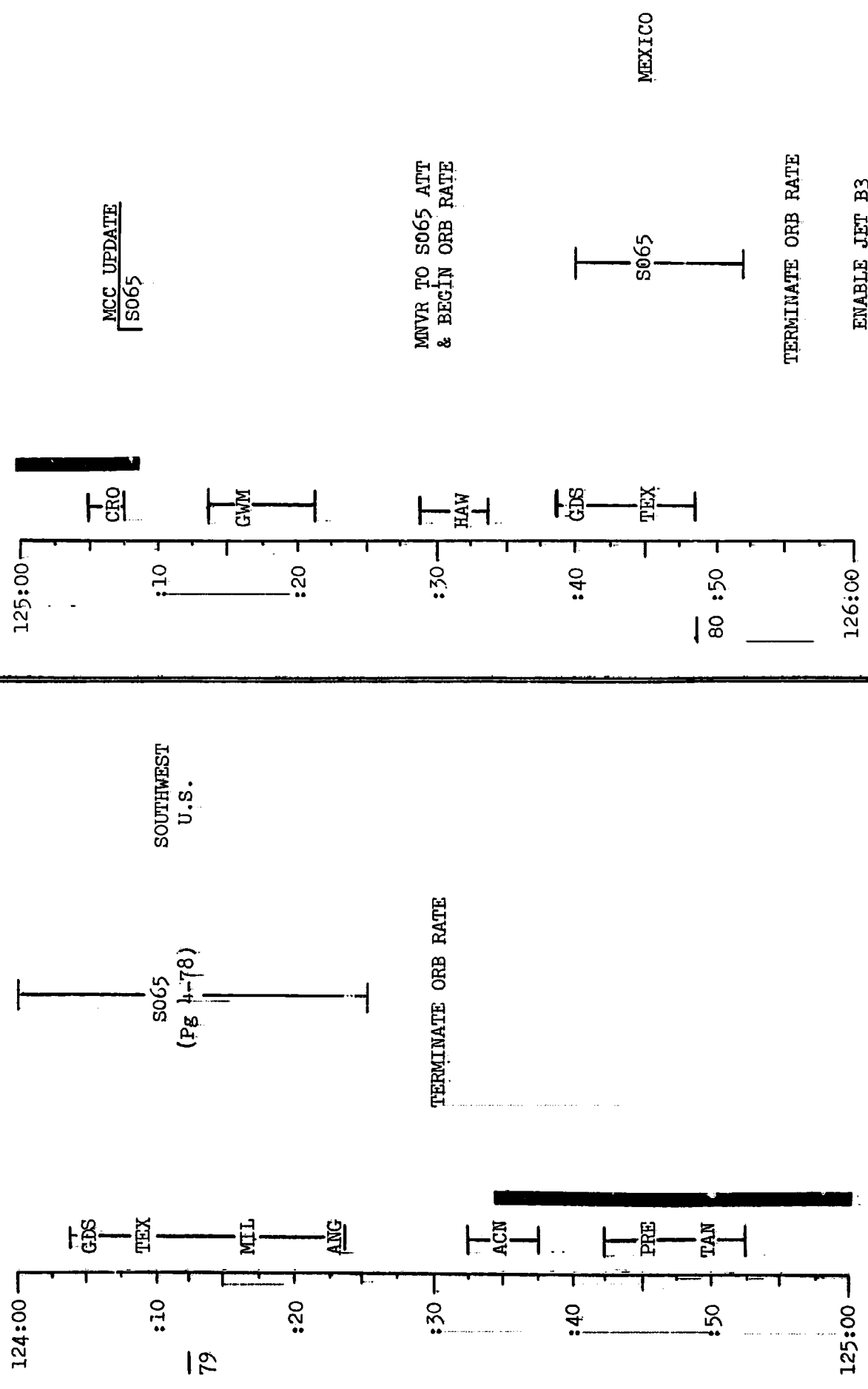

MISSION	EDITION	DATE	TIME	DAY/REV	PAGE
APOLLO 9	FINAL	FEBRUARY 3, 1969	124:00 - 126:00	6/78-80	3-82

# FLIGHT PLAN

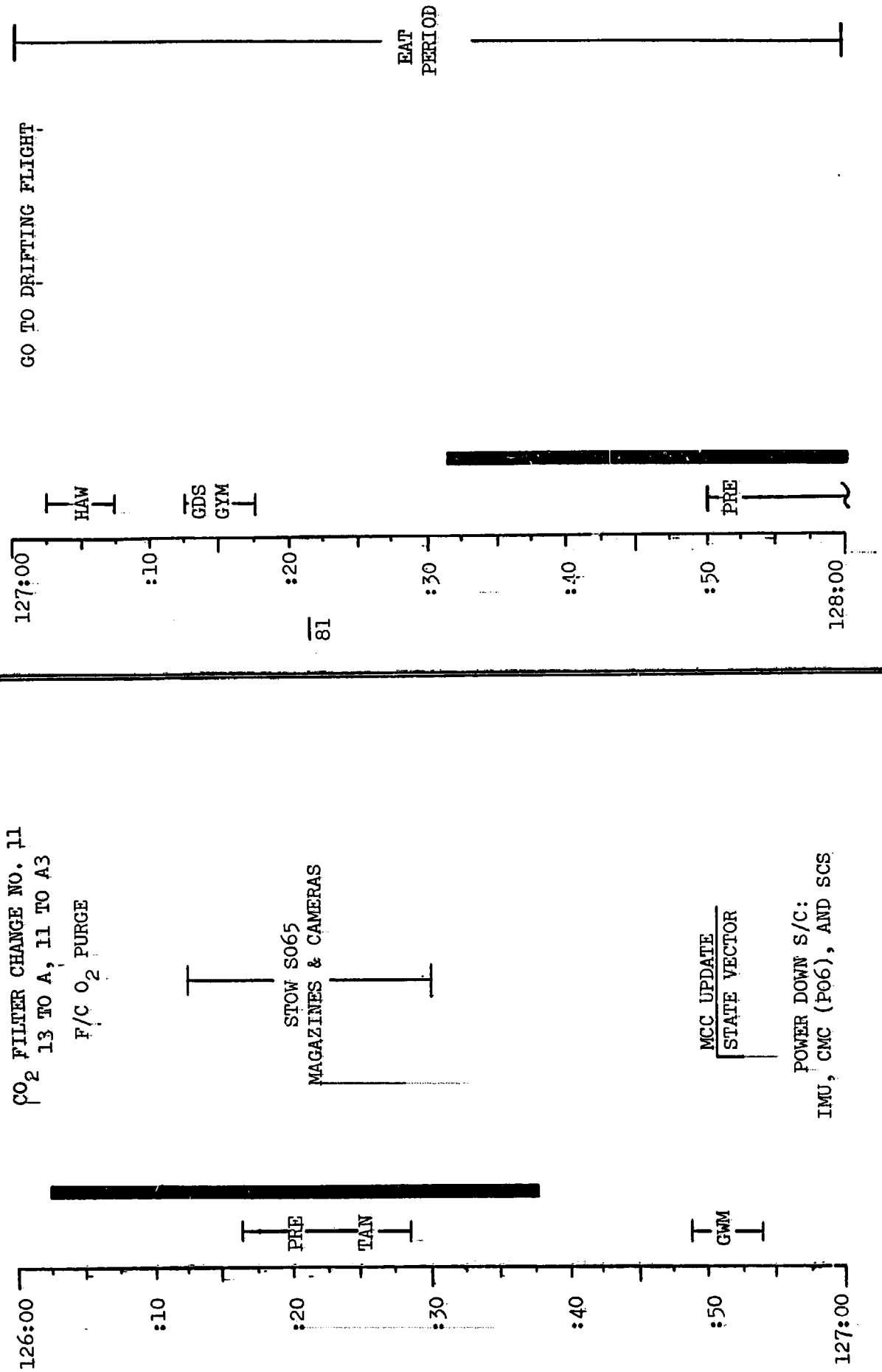

MISSION	EDITION	DATE	TIME	DAY/REV	PAGE
APOLLO 9	FINAL	FEBRUARY 3, 1969	126:00 - 128:00	6/80-81	3-83

# FLIGHT PLAN

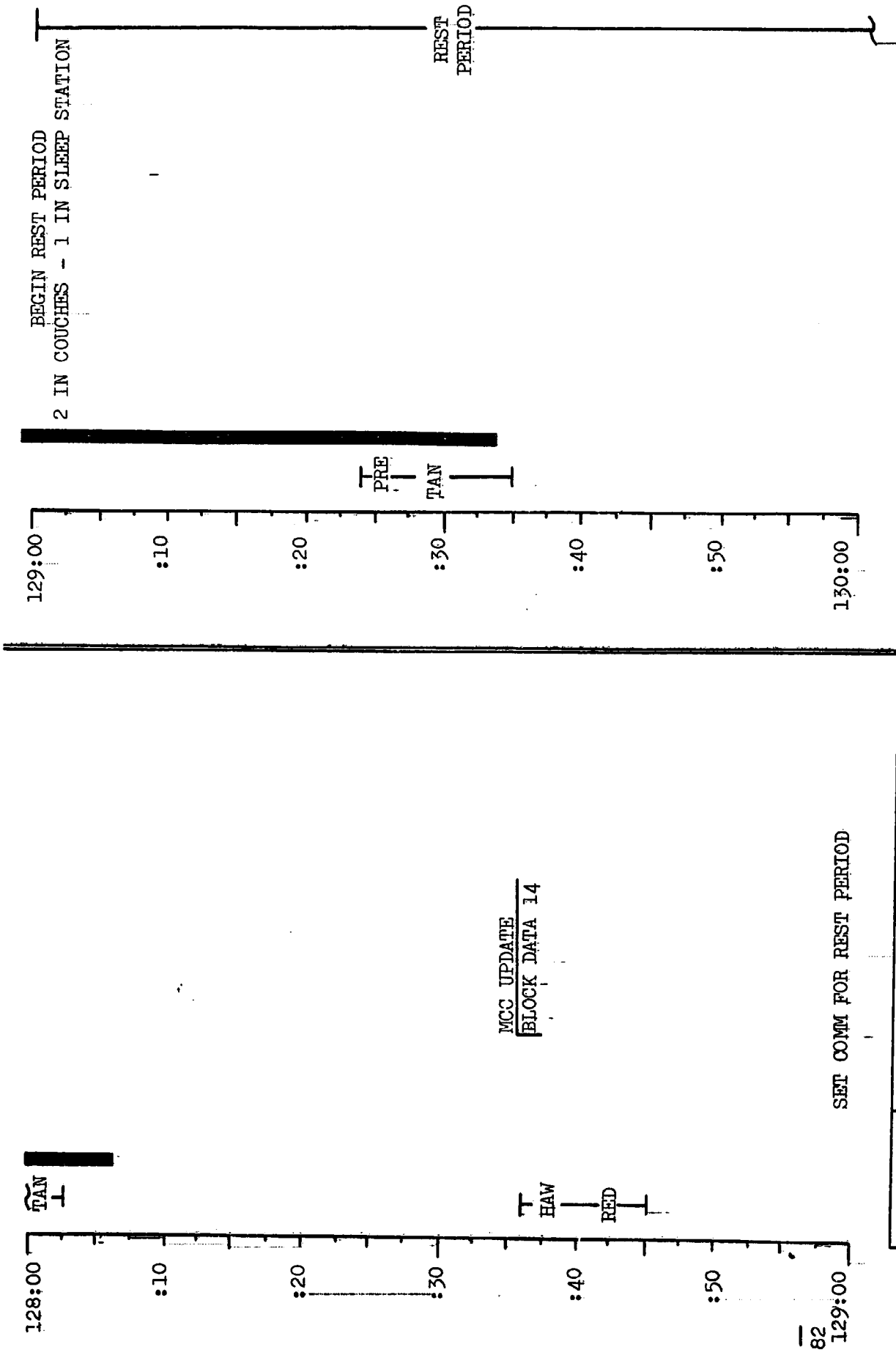

MISSION	EDITION	DATE	TIME	DAY/REV	PAGE
APOLLO 9	FINAL	FEBRUARY 3, 1969	128:00 - 130:00	6/81-82	3-84

# FLIGHT PLAN

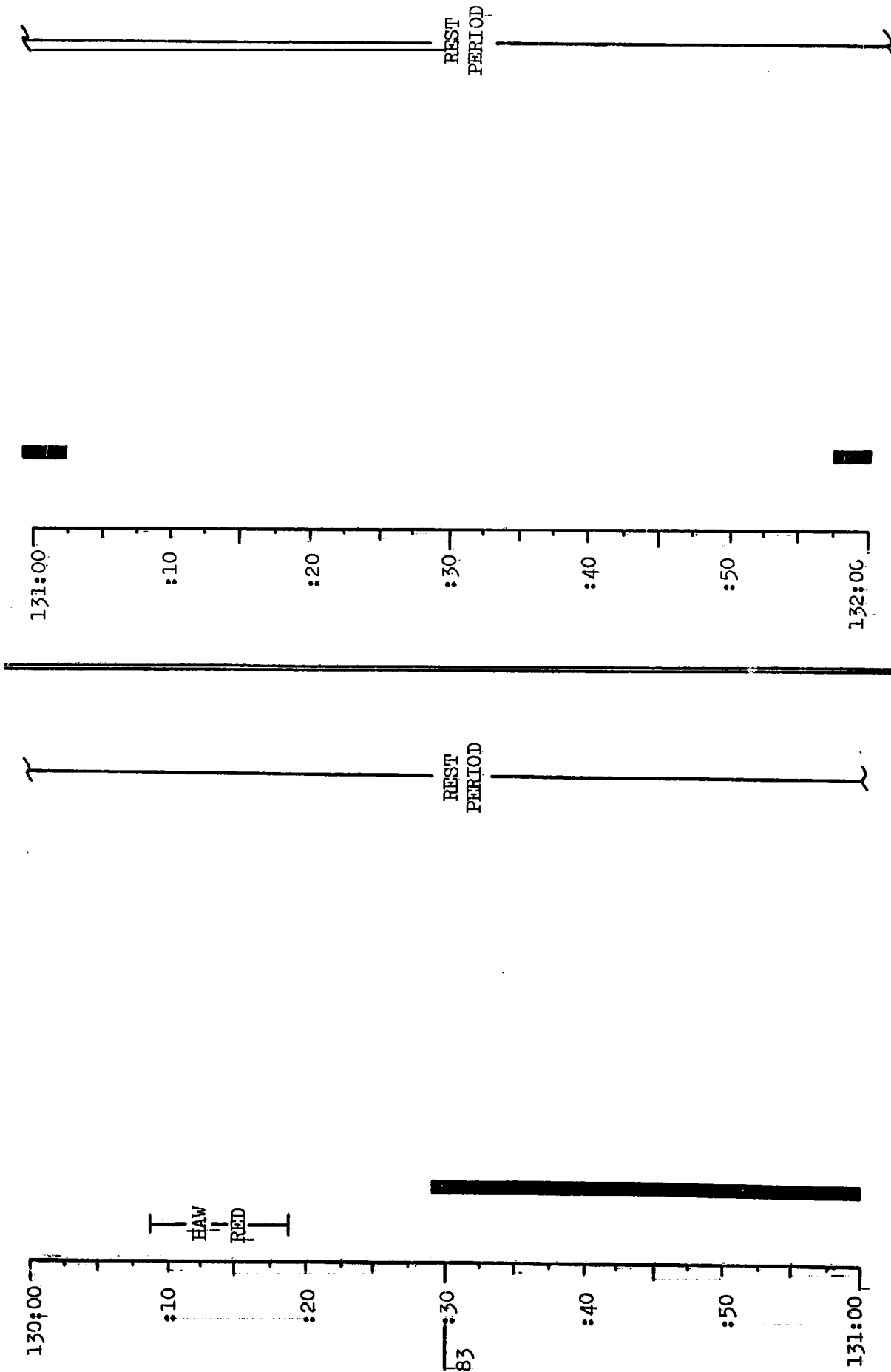

MISSION	EDITION	DATE	TIME	DAY/REV	PAGE
APOLLO 9	FINAL	FEBRUARY 3, 1969	130:00 - 132:00	6/82-83	3-85



# FLIGHT PLAN

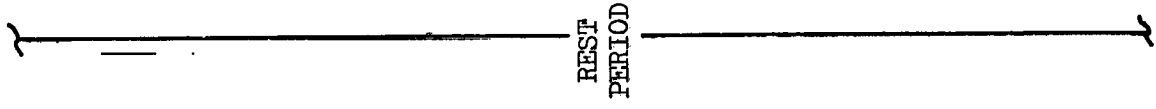
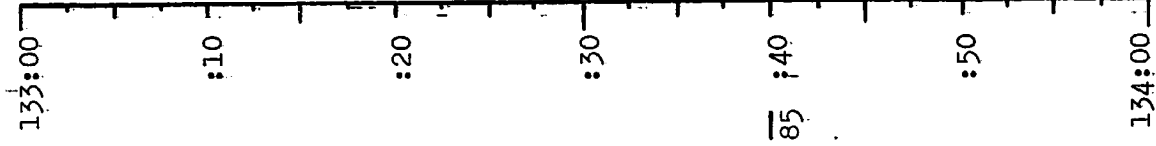
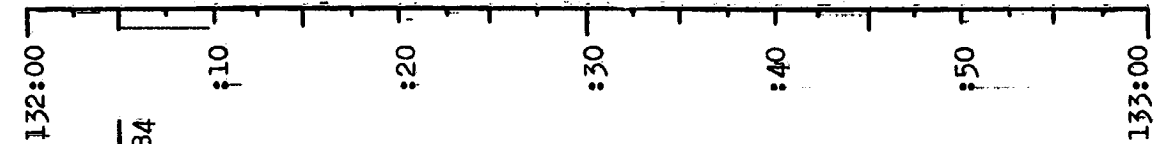

MISSION	EDITION	DATE	TIME	DAY/REV	PAGE
APOLLO 9	FINAL	FEBRUARY 3, 1969	132:00 - 134:00	6/83-85	3-86

# FLIGHT PLAN

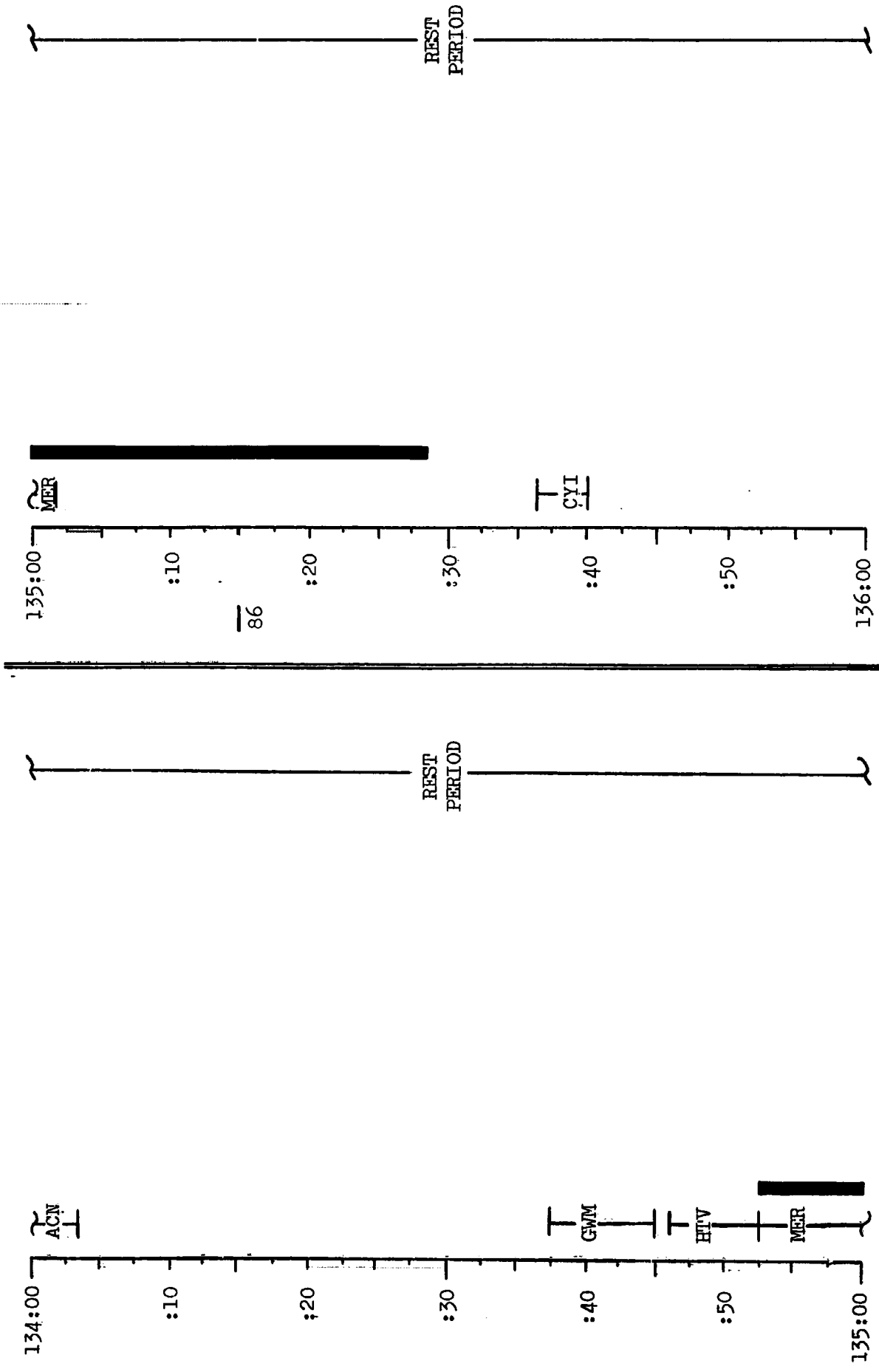

MISSION	EDITION	DATE	TIME	DAY/REV	PAGE
APOLLO 9	FINAL	FEBRUARY 8, 1969	134:00 - 136:00	6/85-86	3-87

# FLIGHT PLAN

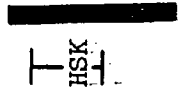
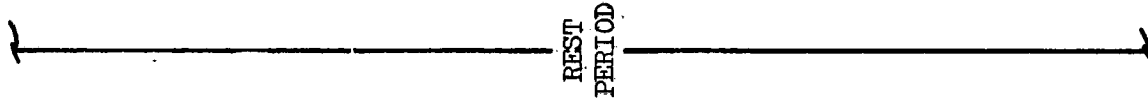
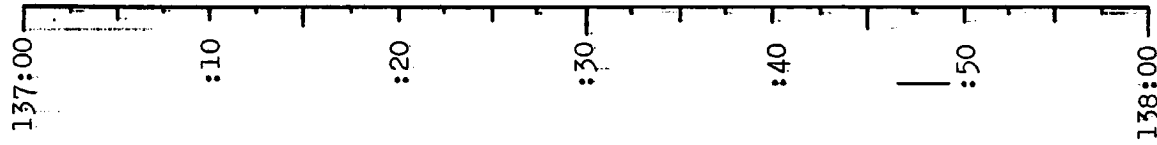
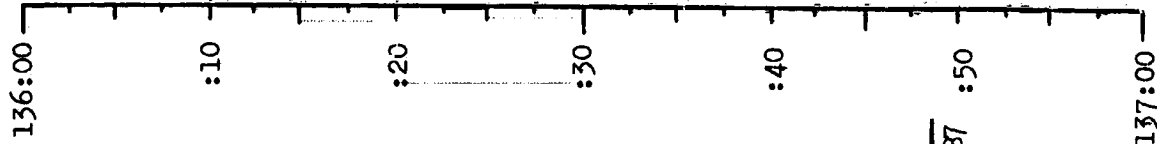

MISSION	EDITION	DATE	TIME	DAY/REV	PAGE
APOLLO 9	FINAL	FEBRUARY 3, 1969	136:00 - 138:00	6/86-87	3-88

# FLIGHT PLAN

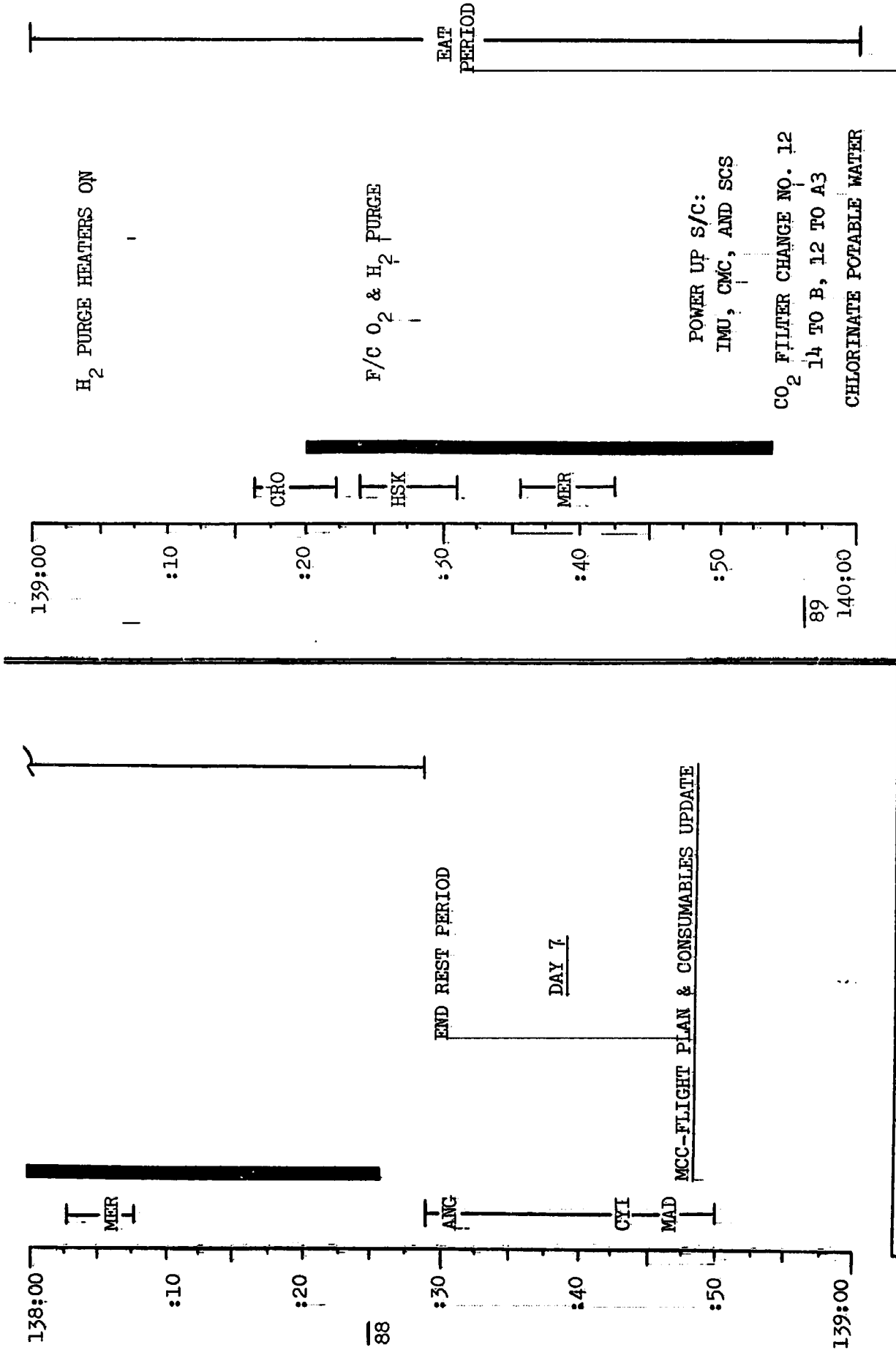

MISSION	EDITION	DATE	TIME	DAY/REV	PAGE
APOLLO 9	FINAL	FEBRUARY 3, 1969	138:00 - 140:00	6-7/87-89	3-89

# FLIGHT PLAN

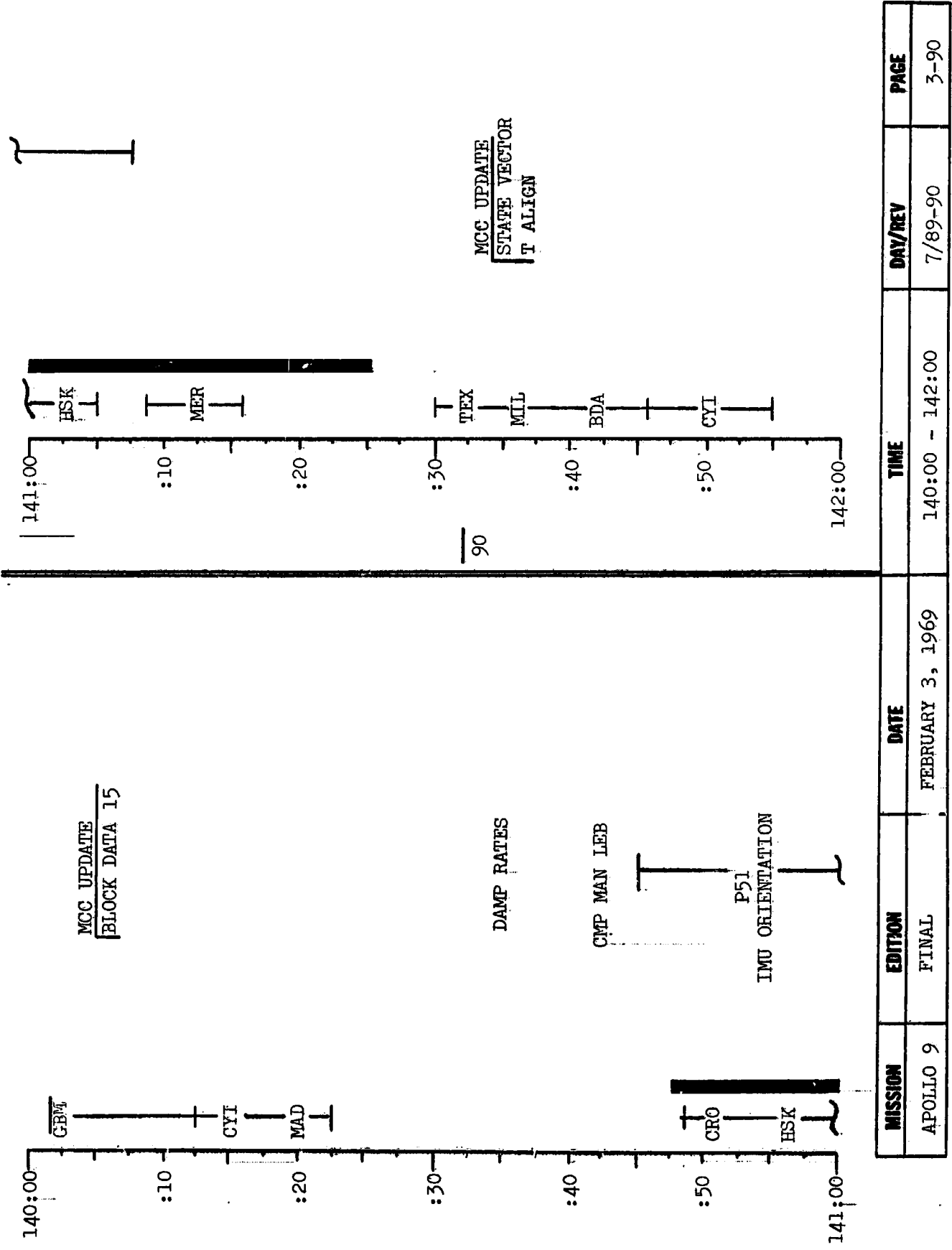

MISSION	EDITION	DATE	TIME	DAY/REV	PAGE
APOLLO 9	FINAL	FEBRUARY 3, 1969	140:00 - 142:00	7/89-90	3-90

# FLIGHT PLAN

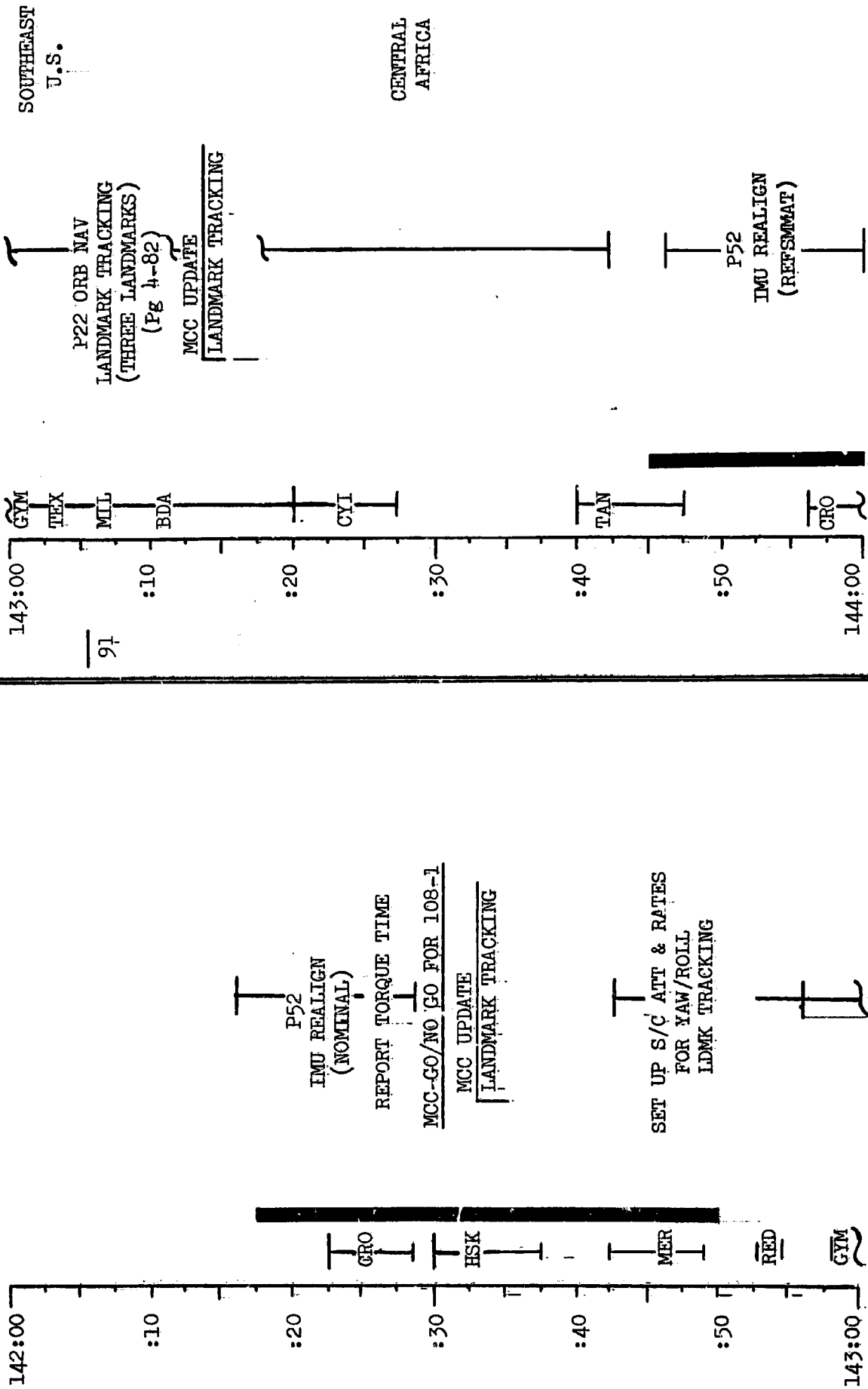

MISSION	EDITION	DATE	TIME	DAY/REV	PAGE
APOLLO 9	FINAL	FEBRUARY 3, 1969	142:00 - 144:00	7/90-91	3-91

# FLIGHT PLAN

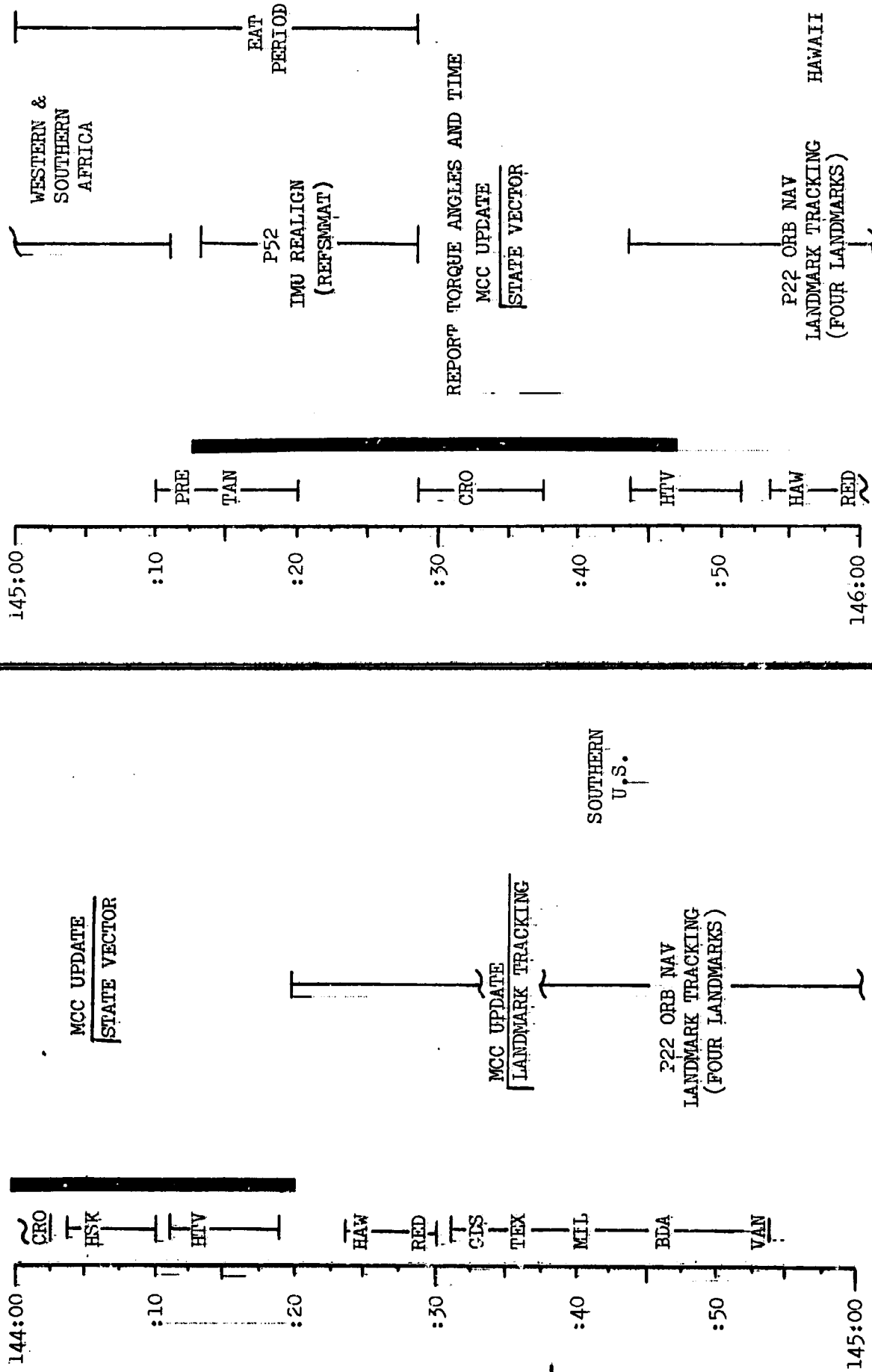

MISSION	EDITION	DATE	TIME	DAY/REV	PAGE
APOLLO 9	FINAL	FEBRUARY 3, 1969	144:00 - 146:00	7/91-92	3-92

# FLIGHT PLAN

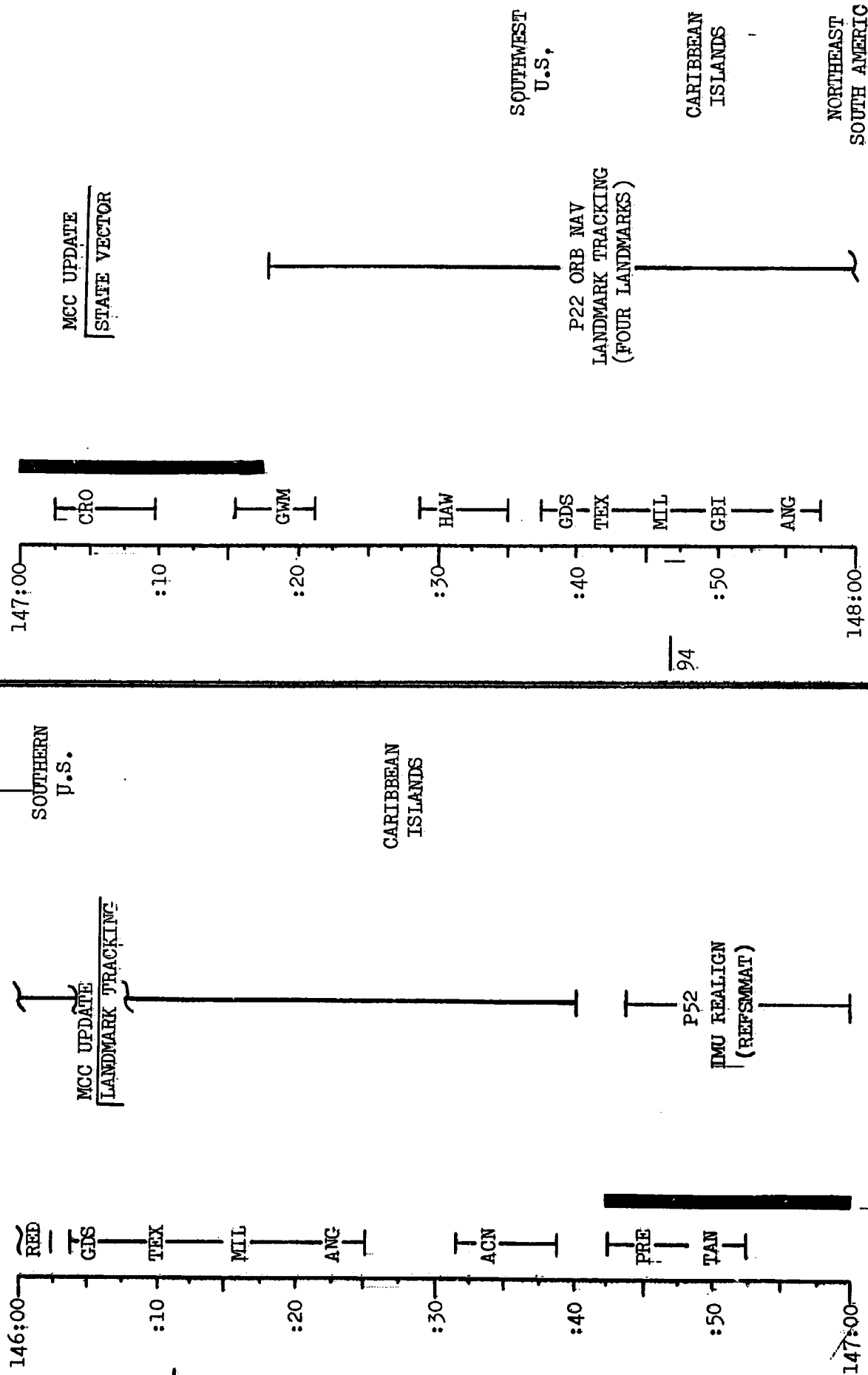

MISSION	EDITION	DATE	TIME	DAY/REV	PAGE
APOLLO 9	FINAL	FEBRUARY 3, 1969	146:00 - 148:00	7/92-94	3-93



# FLIGHT PLAN

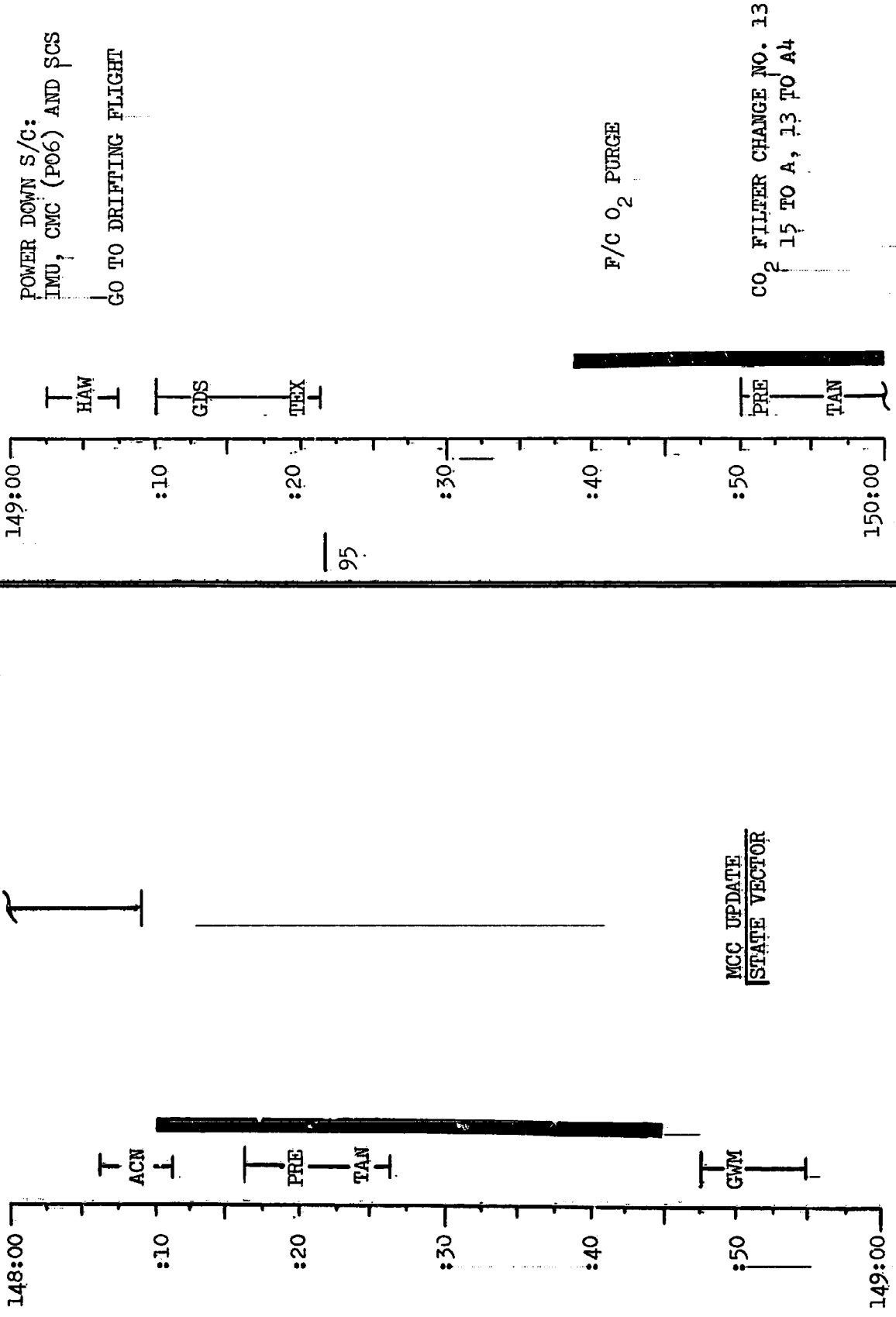

95

MCC UPDATE  
STATE VECTOR

MISSION	EDITION	DATE	TIME	DAY/REV	PAGE
APOLLO 9	FINAL	FEBRUARY 3, 1969	148:00 - 150:00	7/94-95	3-94

# FLIGHT PLAN

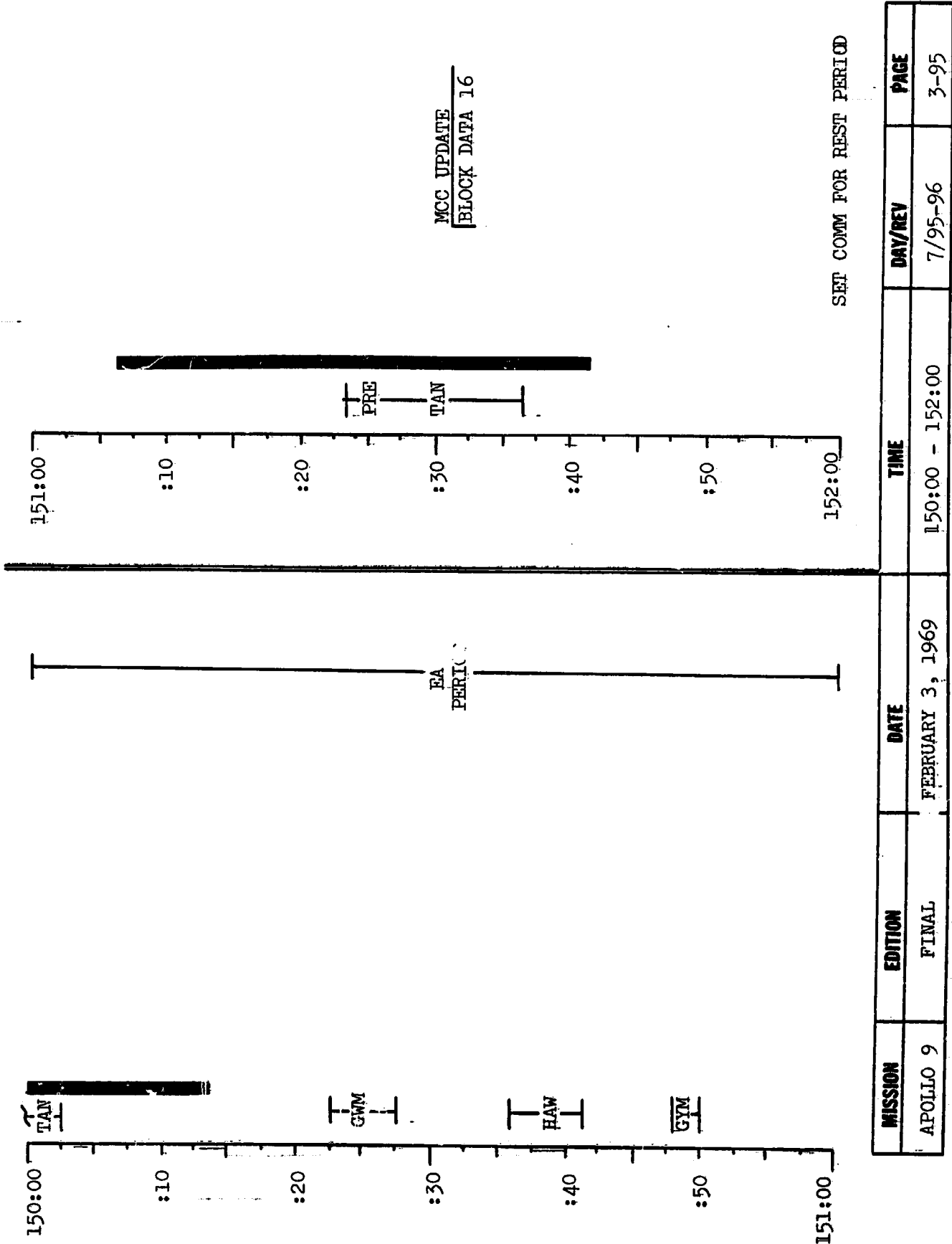

MCC UPDATE  
BLOCK DATA 16

SET COMM FOR REST PERIOD

MISSION	EDITION	DATE	TIME	DAY/REV	PAGE
APOLLO 9	FINAL	FEBRUARY 3, 1969	150:00 - 152:00	7/95-96	3-95

# FLIGHT PLAN

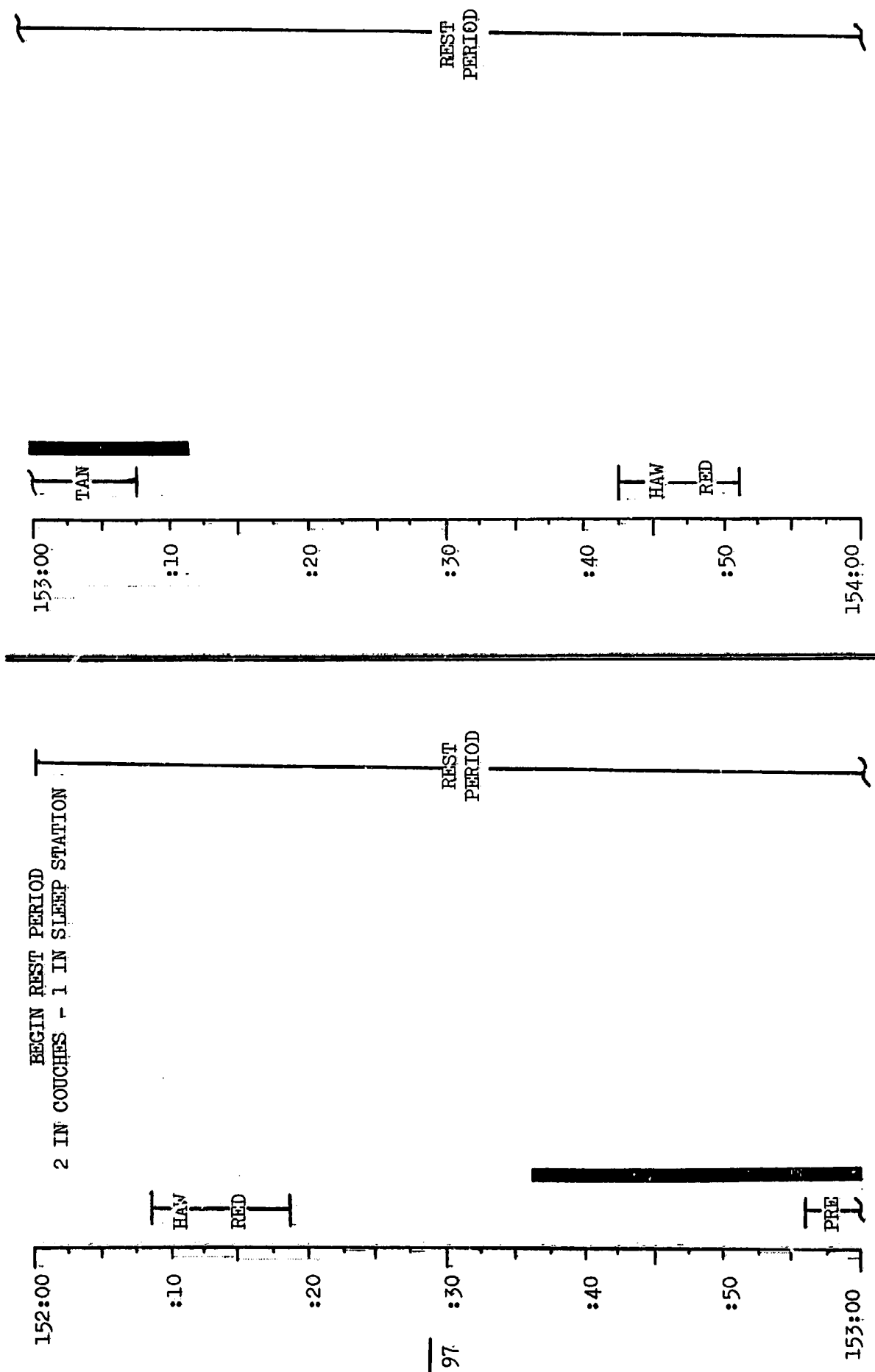

97

MISSION	EDITION	DATE	TIME	DAY/REV	PAGE
APOLLO 9	FINAL	FEBRUARY 3, 1969	152:00 - 154:00	7/96-97	3-96

# FLIGHT PLAN

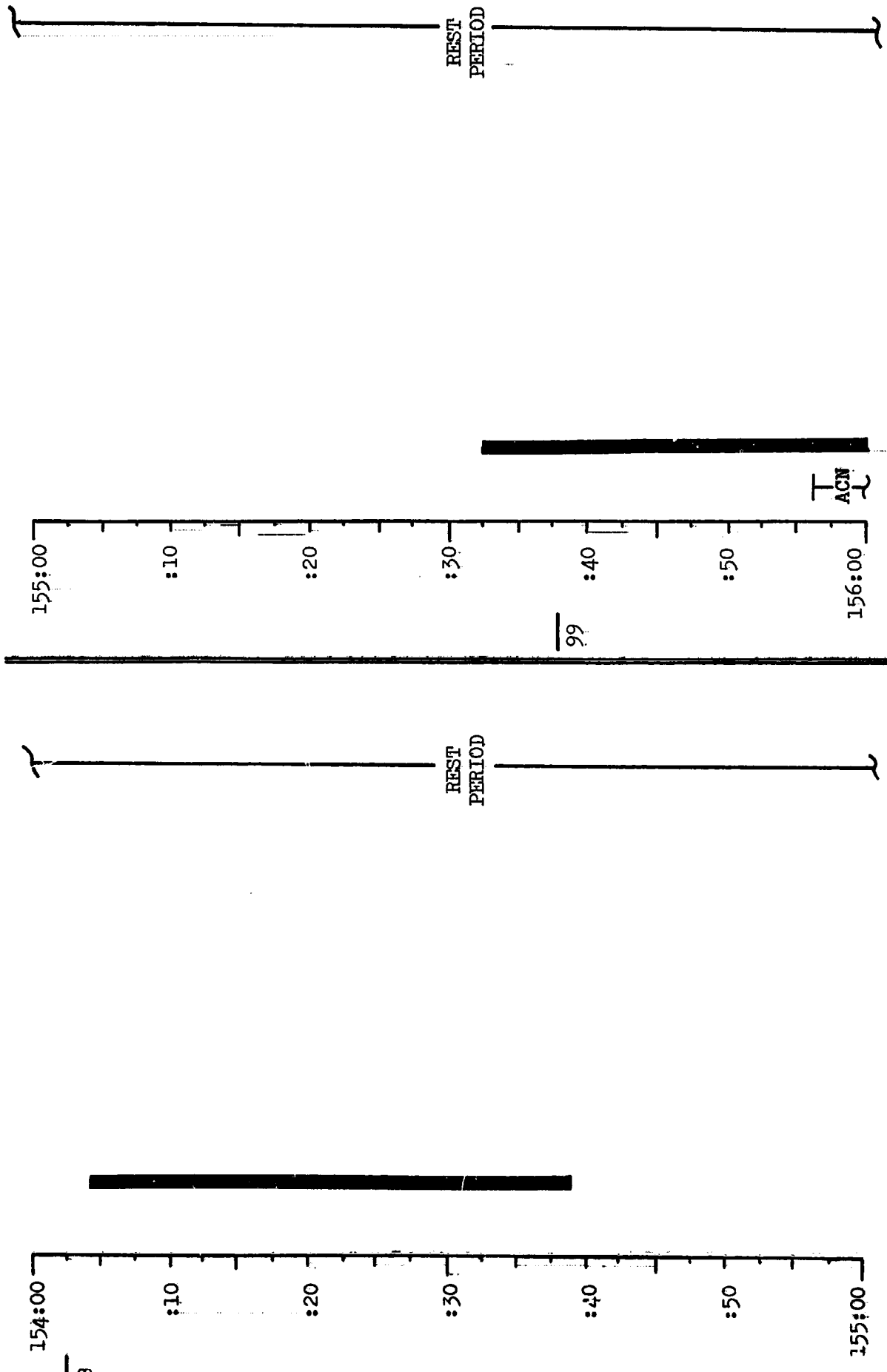

MISSION	EDITION	DATE	TIME	DAY/REV	PAGE
APOLLO 9	FINAL	FEBRUARY 3, 1969	154:00 - 156:00	7/98-99	3-97

# FLIGHT PLAN

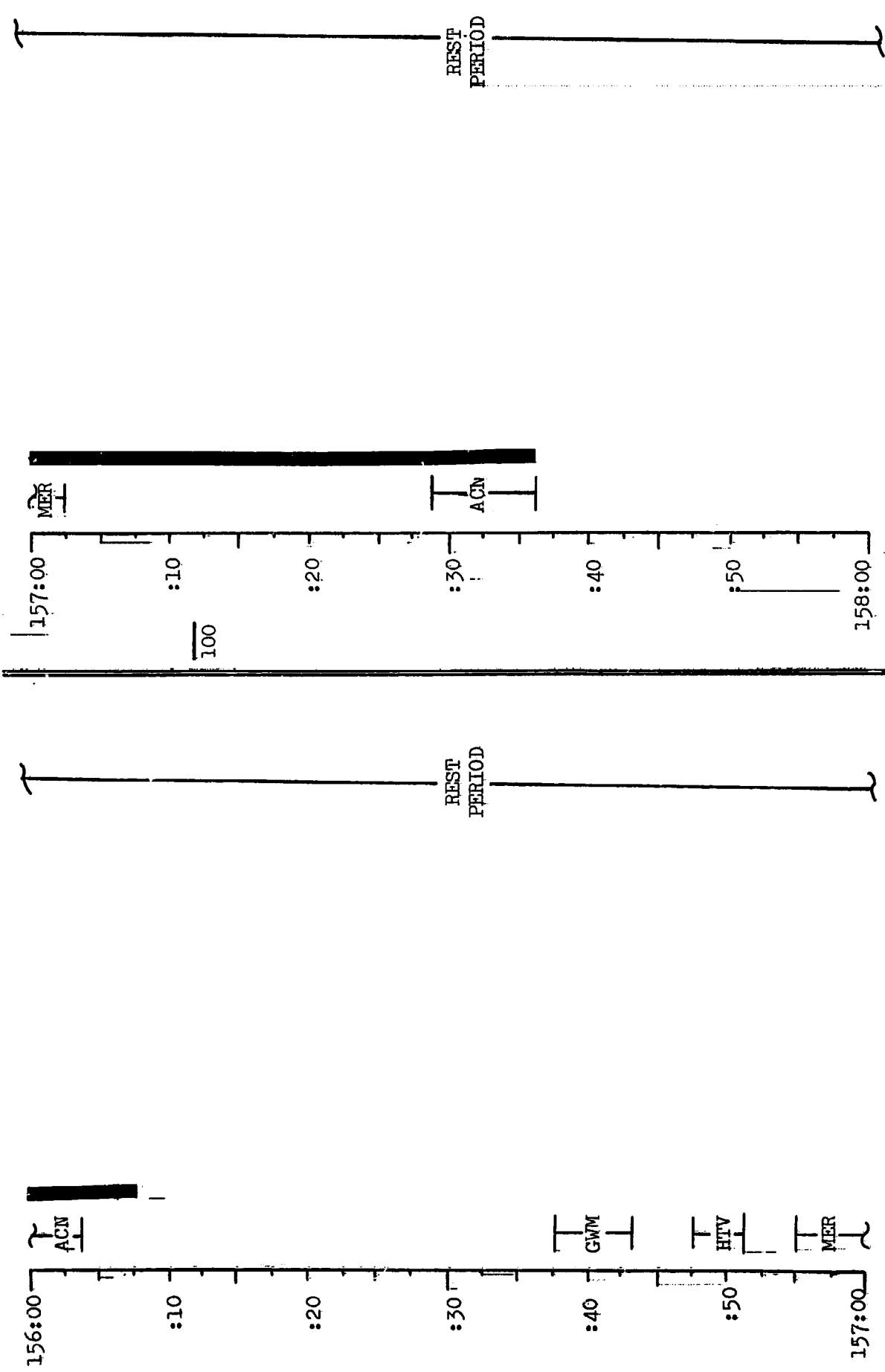

MISSION	EDITION	DATE	TIME	DAY/REV	PAGE
APOLLO 9	FINAL	FEBRUARY 3, 1969	156:00 - 158:00	7/99-1.00	3-98

# FLIGHT PLAN

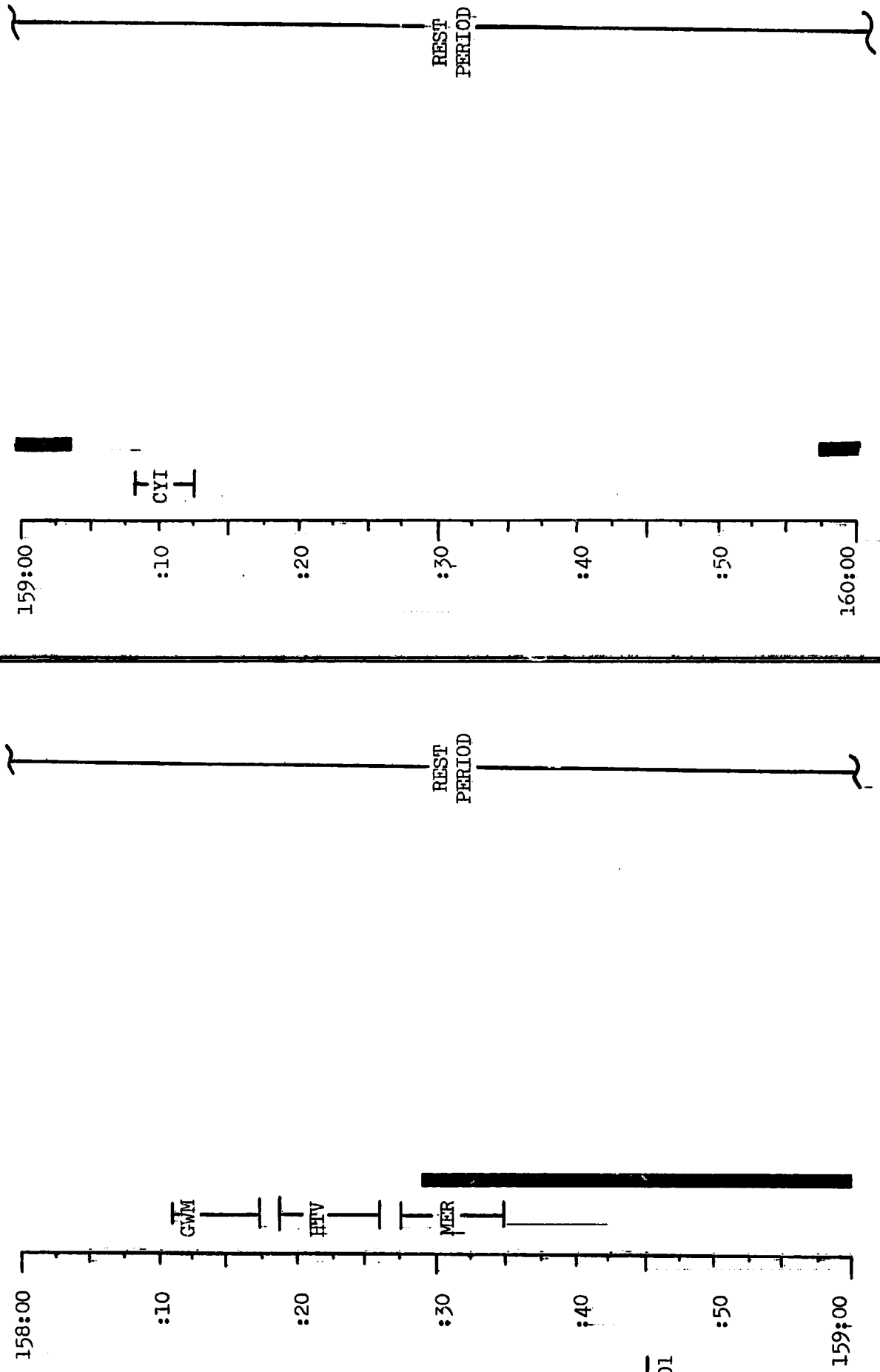

MISSION	EDITION	DATE	TIME	DAY/REV	PAGE
APOLLO 9	FINAL	FEBRUARY 3, 1969	158:00 - 160:00	7/100-101	3-99

# FLIGHT PLAN

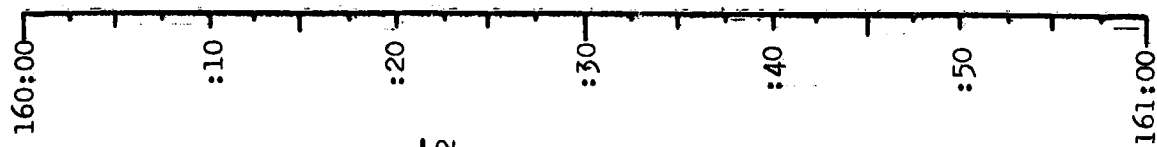

102

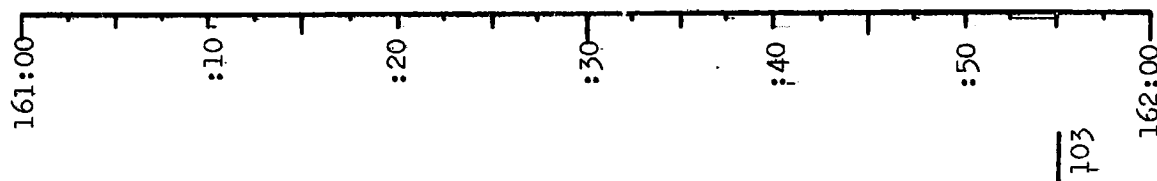

103

MISSION	EDITION	DATE	TIME	DAY/REV	PAGE
APOLLO 9	FINAL	FEBRUARY 3, 1969	160:00 - 162:00	7/101-103	3-100

# FLIGHT PLAN

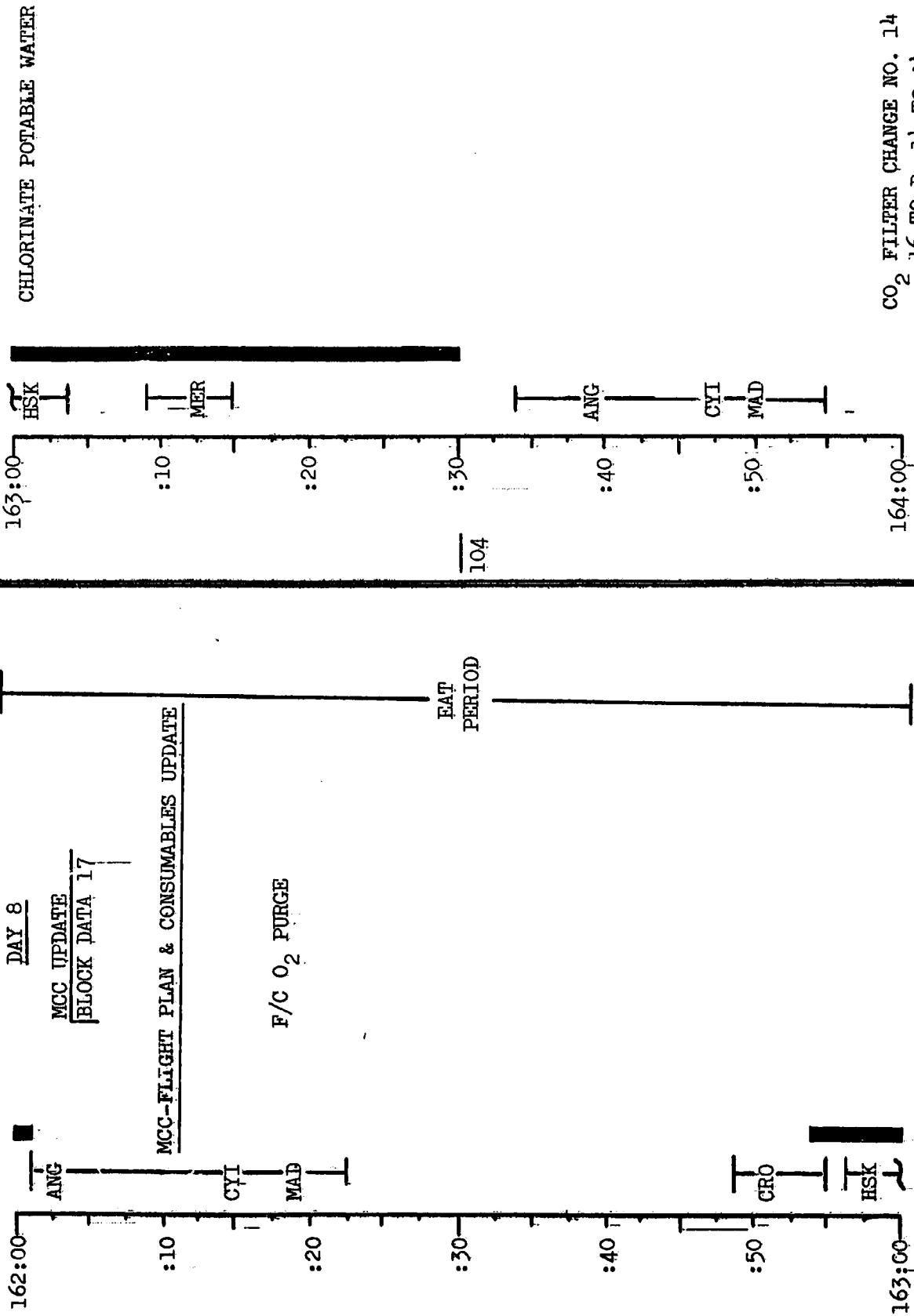

CO<sub>2</sub> FILTER CHANGE NO. 14  
IC TO B, 14 TO A4



# FLIGHT PLAN

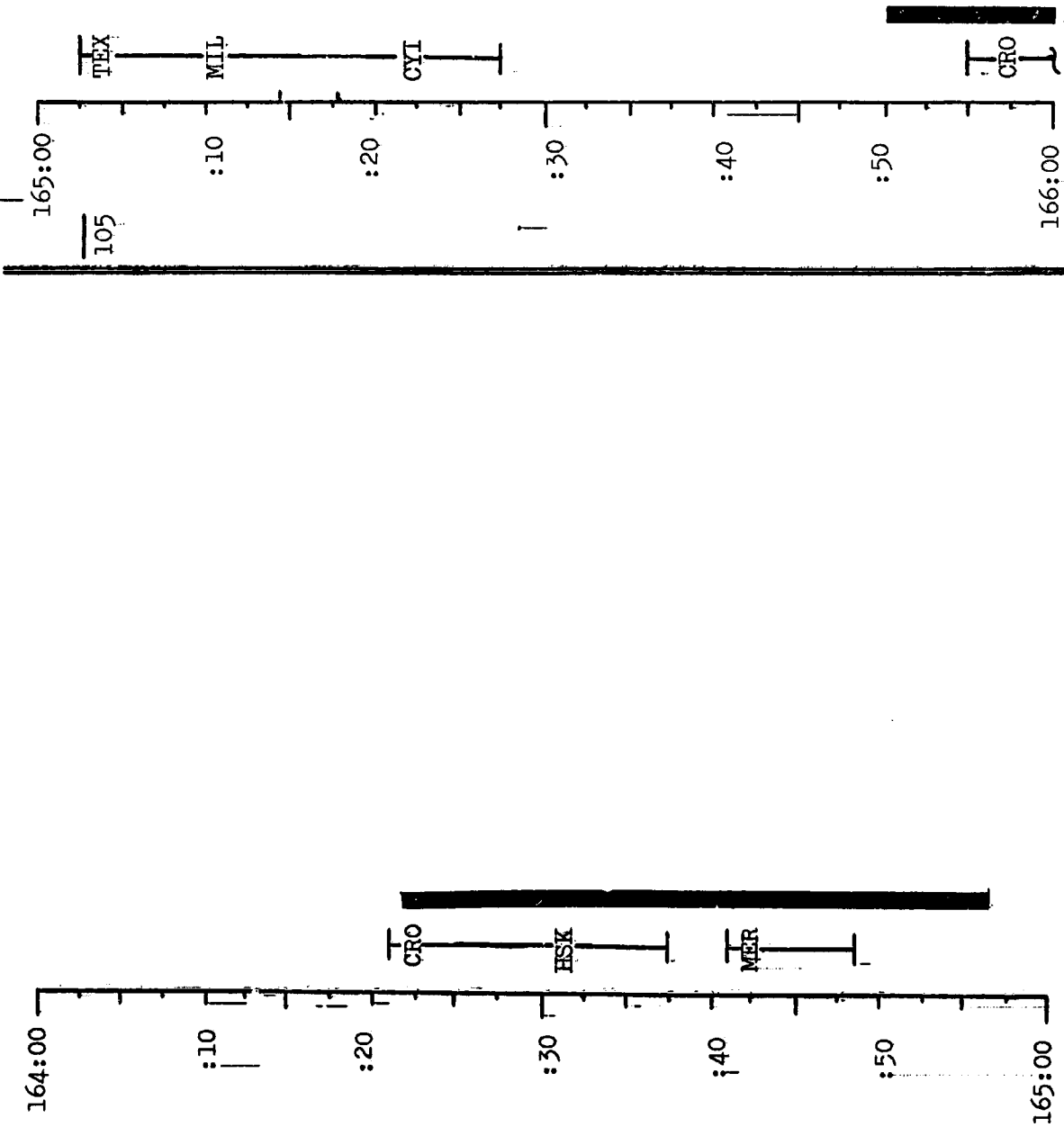

MISSION	EDITION	DATE	TIME	DAY/REV	PAGE
APOLLO 9	FINAL	FEBRUARY 3, 1969	164:00 - 166:00	8/104-105	3-102

# FLIGHT PLAN

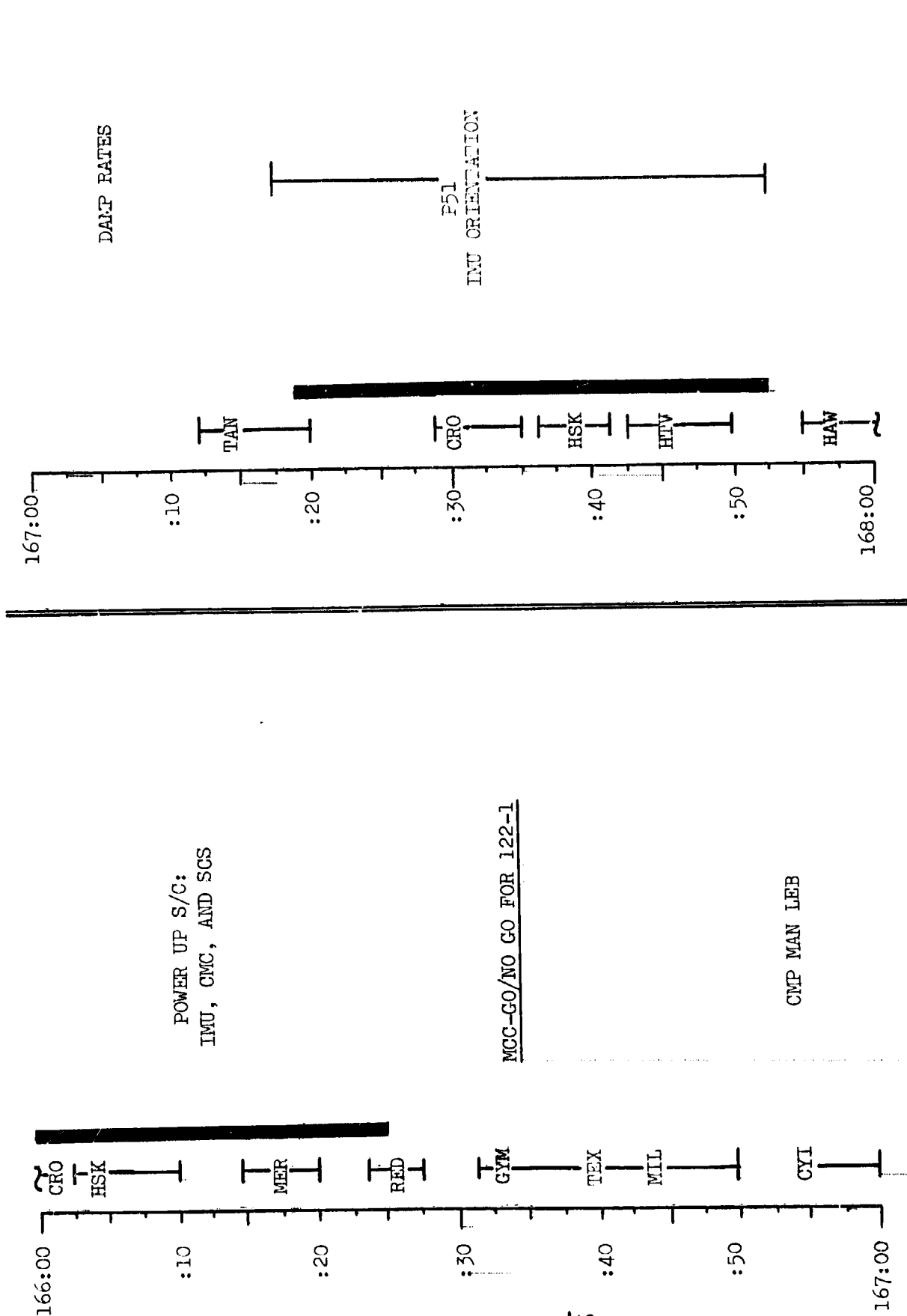

MISSION	EDITION	DATE	TIME	DAY/REV	PAGE
APOLLO 9	FINAL	FEBRUARY 3, 1969	166:00 - 168:00	8/105-106	3-103

# FLIGHT PLAN

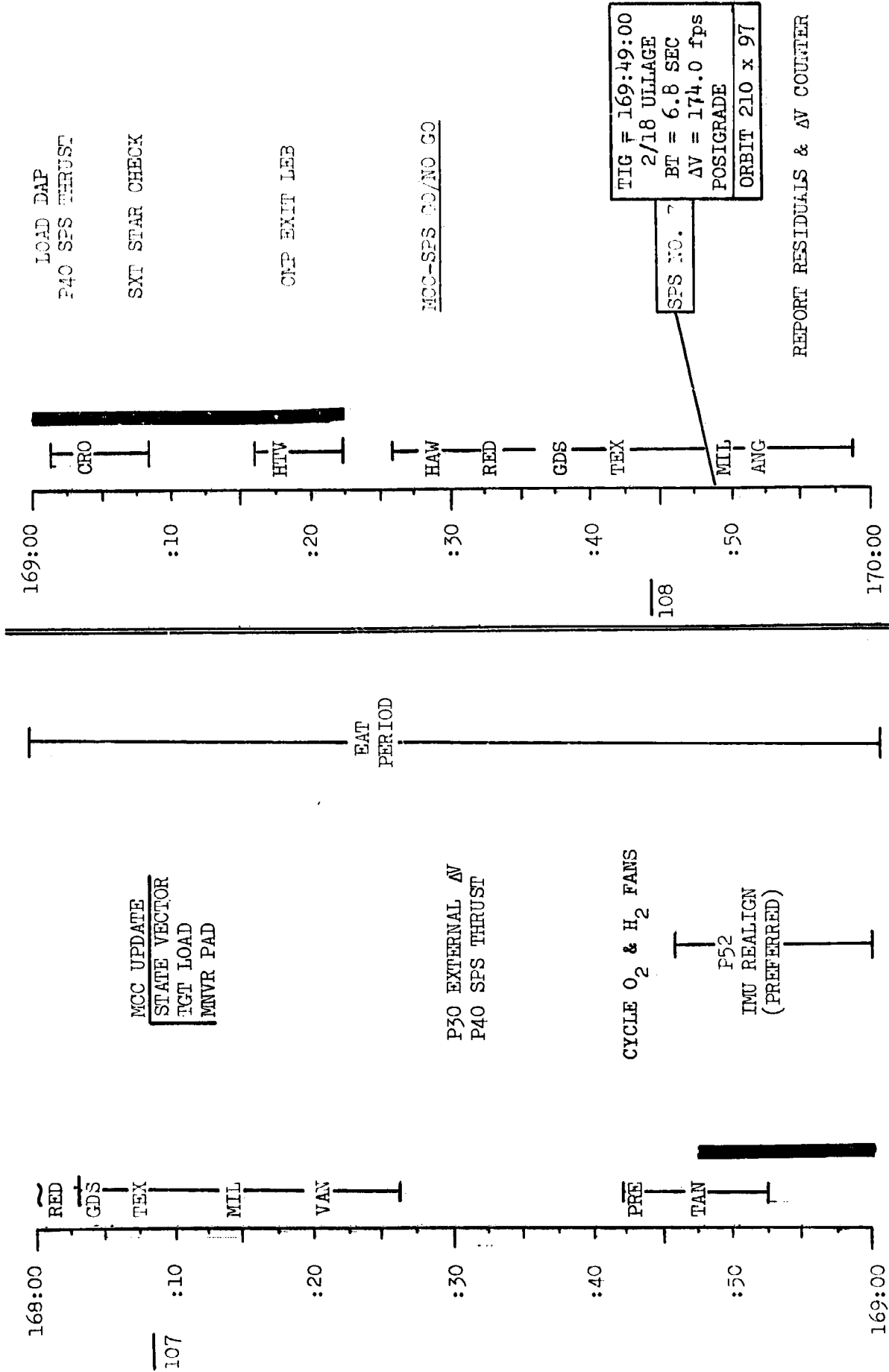

MISSION	EDITION	DATE	TIME	DAY/REV	PAGE
APOLLO 9	FINAL	FEBRUARY 3, 1969	168:00 - 170:00	8/106-106	3-104

# FLIGHT PLAN

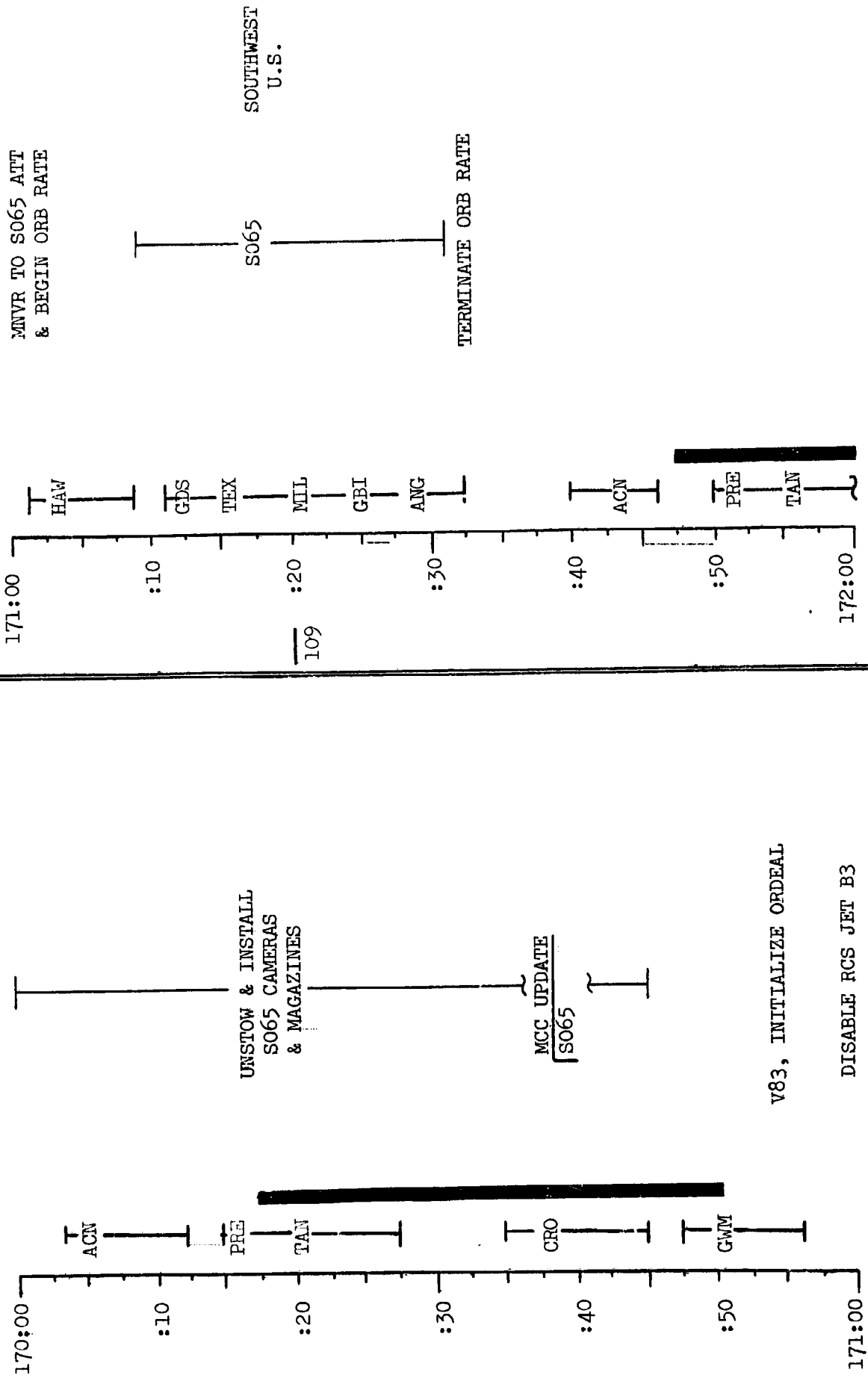

MISSION	EDITION	DATE	TIME	DAY/REV	PAGE
APOLLO 9	FINAL	FEBRUARY 3, 1969	170:00 - 172:00	8/108-109	3-105

# FLIGHT PLAN

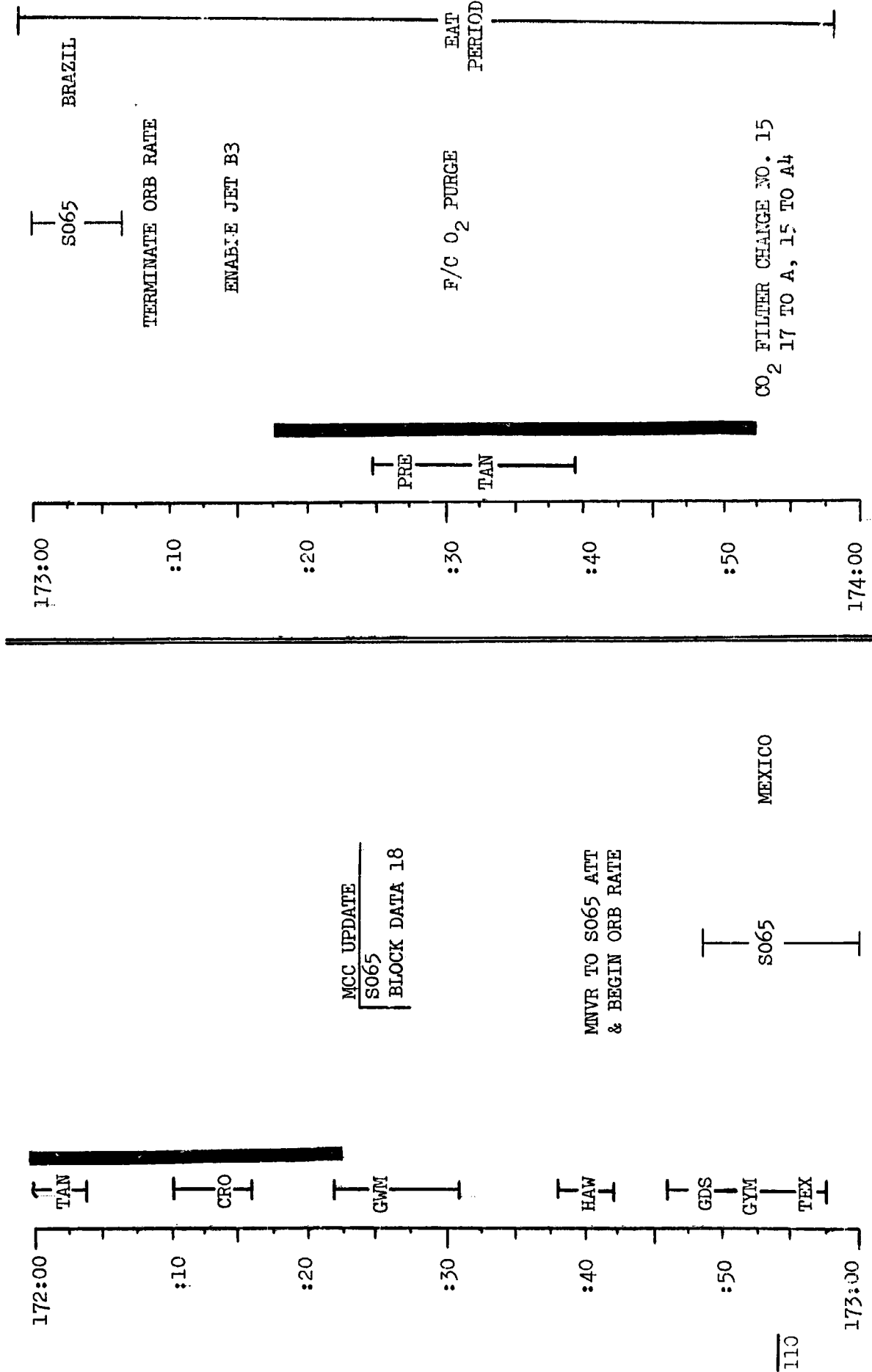

MISSION	EDITION	DATE	TIME	DAY/REV	PAGE
APOLLO 9	FINAL	FEBRUARY 3, 1969	172:00 - 174:00	8/109-110	3-106

# FLIGHT PLAN

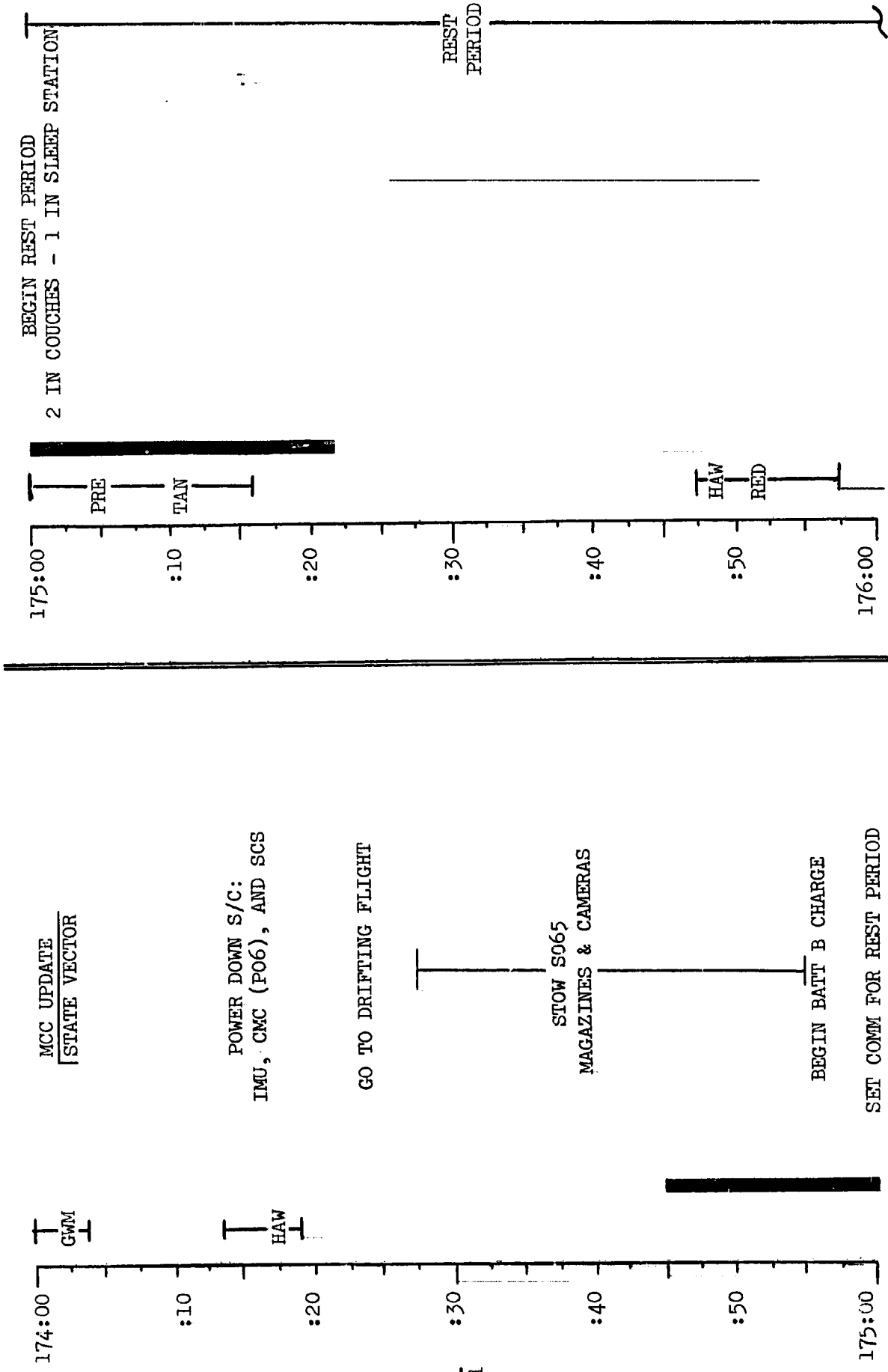

MISSION	EDITION	DATE	TIME	DAY/REV	PAGE
APOLLO 9	FINAL	FEBRUARY 3, 1969	174:00 - 176:00	8/110-111	3-107

# FLIGHT PLAN

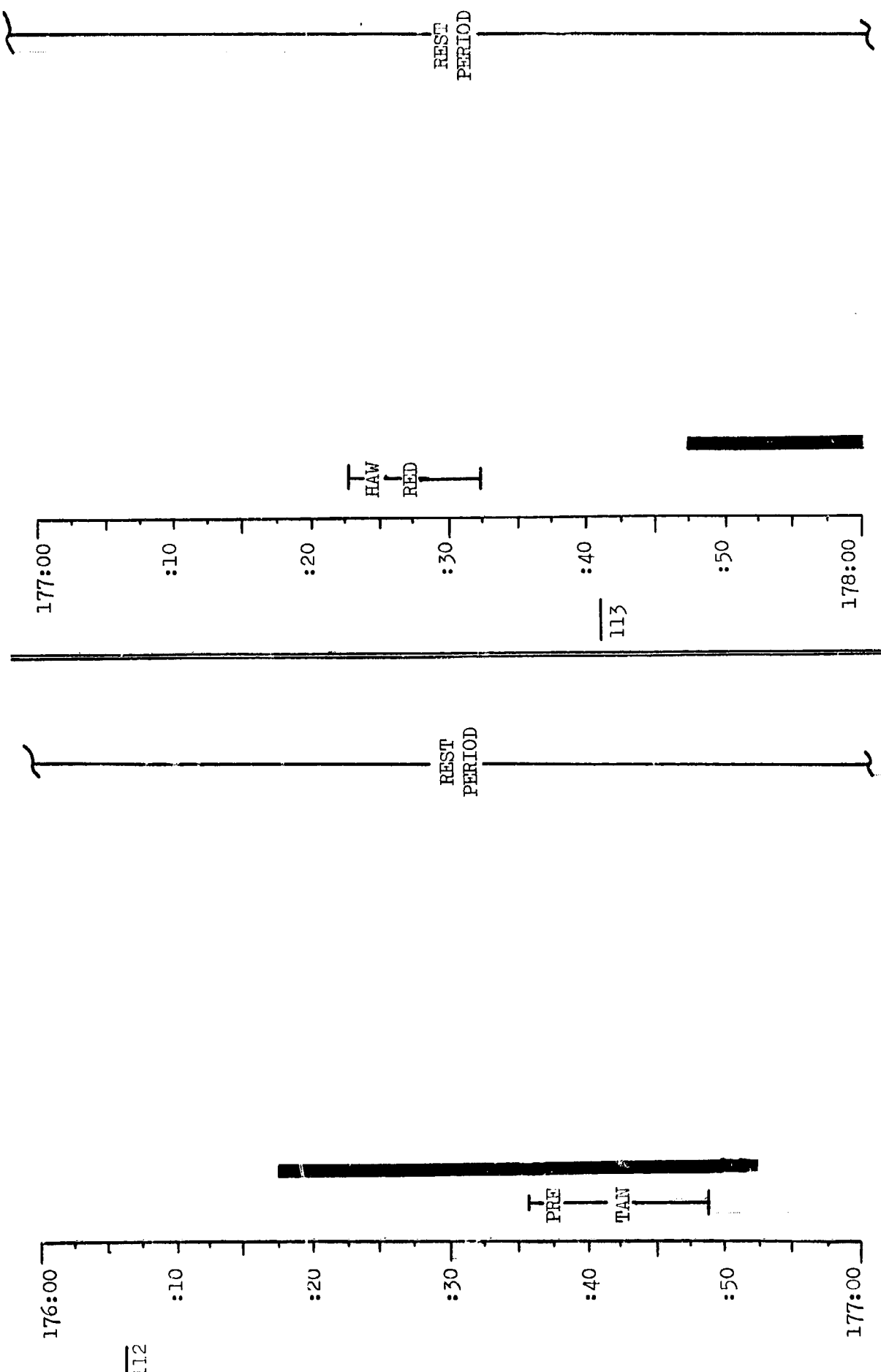

MISSION	EDITION	DATE	TIME	DAY/REV	PAGE
APOLLO 9	FINAL	FEBRUARY 3, 1969	176:00 - 178:00	8/111-113	3-108

# FLIGHT PLAN

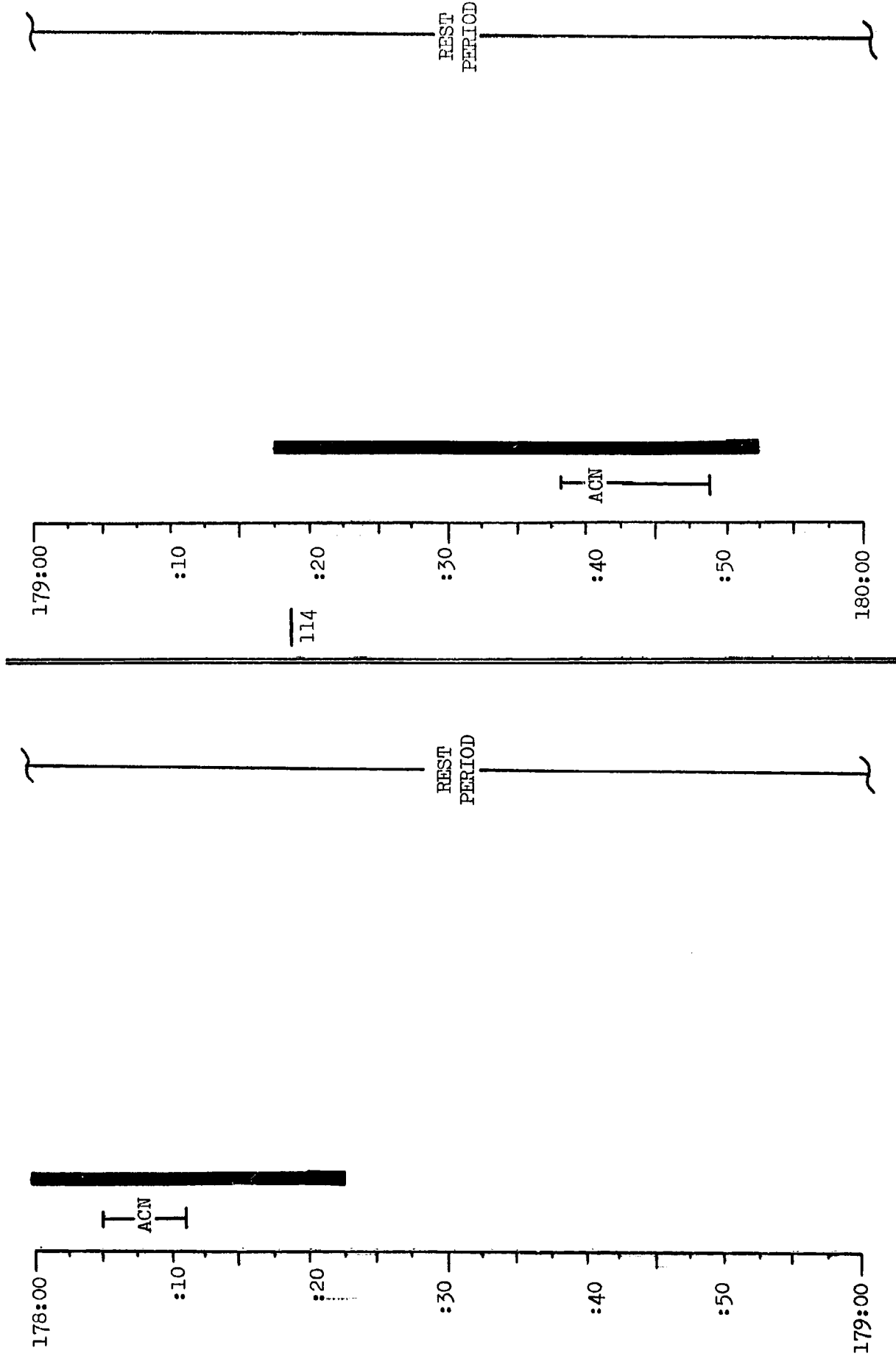

MISSION	EDITION	DATE	TIME	DAY/REV	PAGE
APOLLO 9	FINAL	FEBRUARY 3, 1969	178:00 - 180:00	8/115-114	3-109



# FLIGHT PLAN

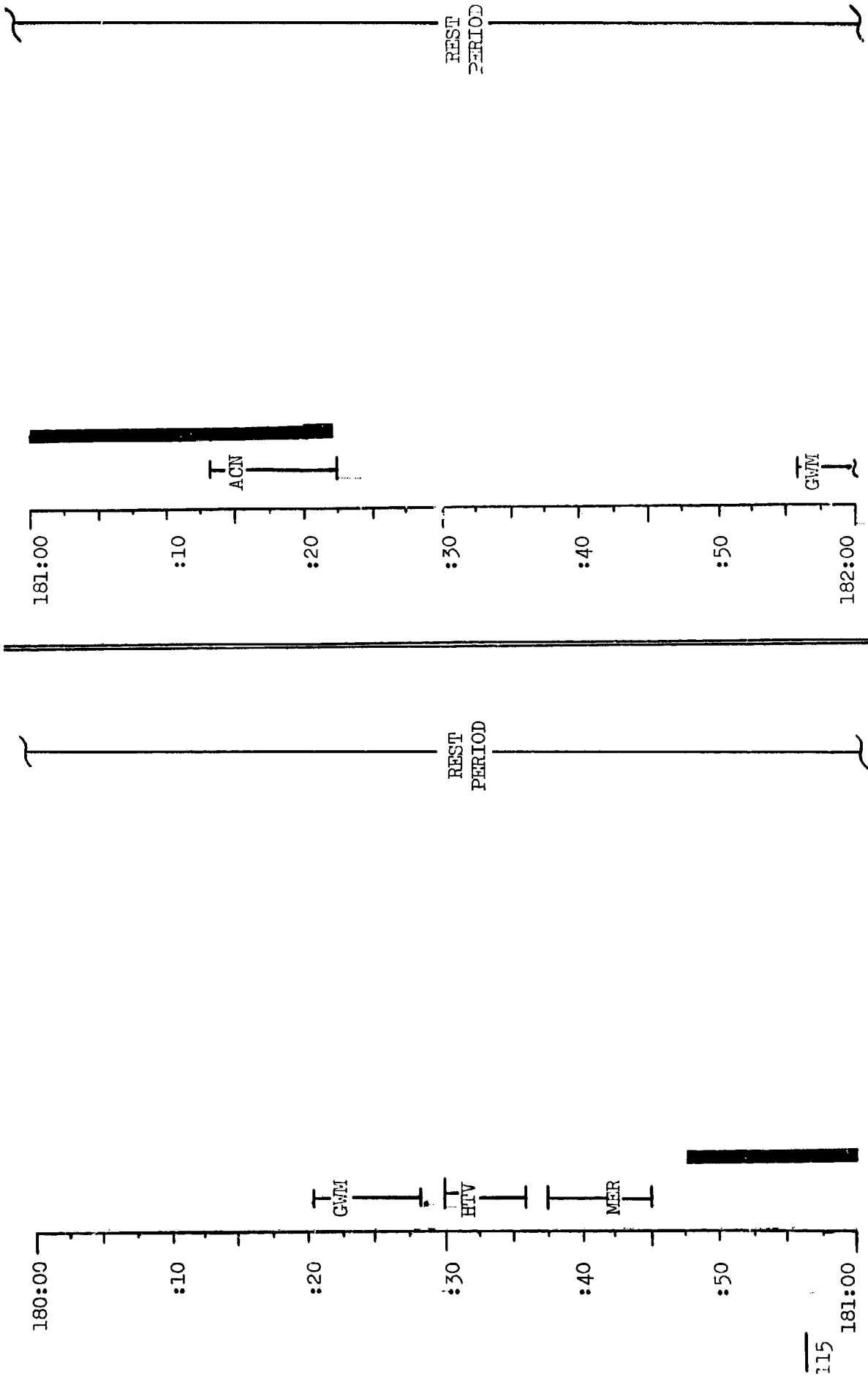

MISSION	EDITION	DATE	TIME	PAY/REV	PAGE
APOLLO 9	FINAL	FEBRUARY 3, 1969	180:00 - 182:00	8/114-115	3-110

# FLIGHT PLAN

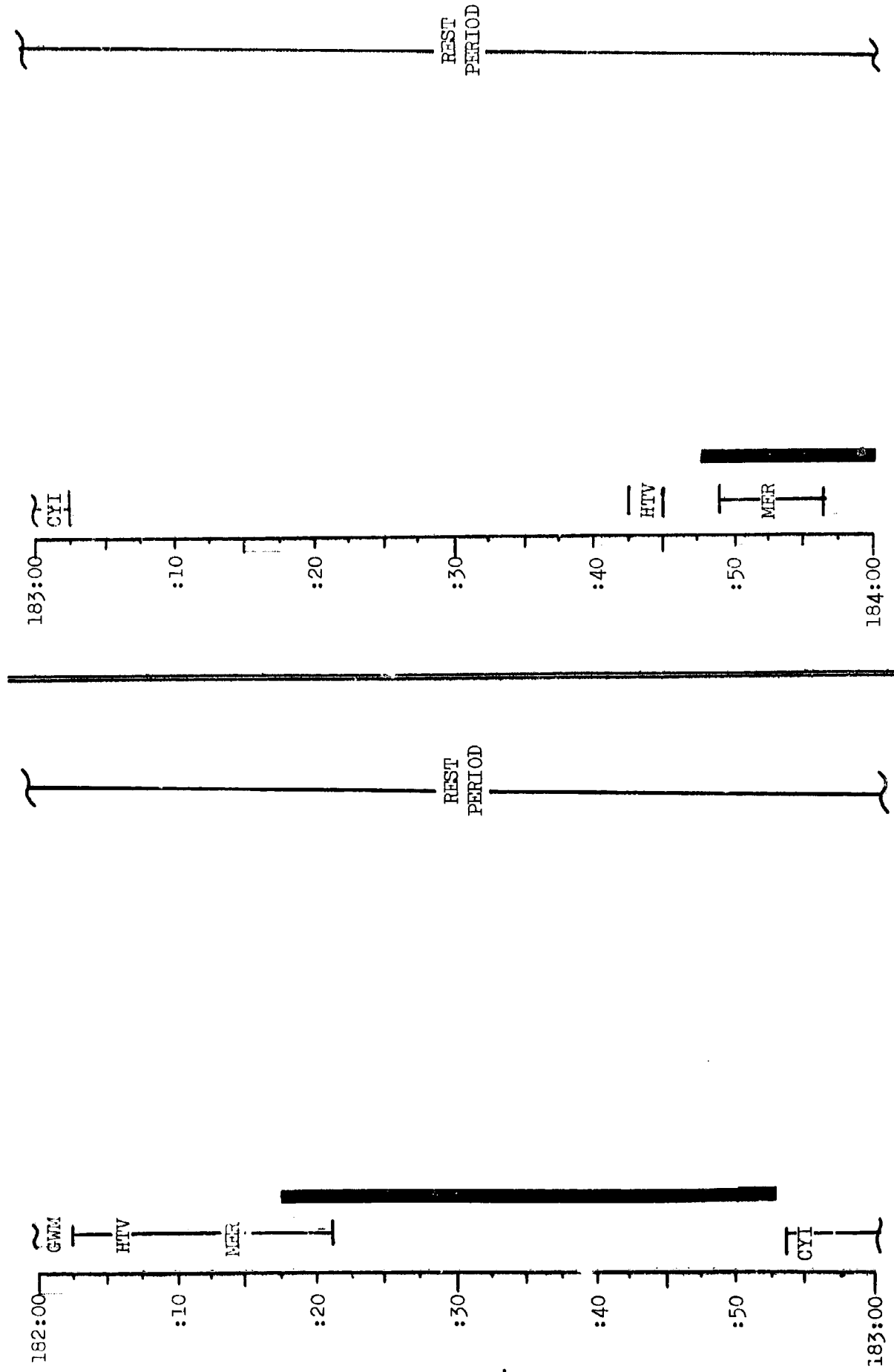

MISSION	EDITION	DATE	TIME	DAY/REV	PAGE
APOLLO 9	FINAL	FEBRUARY 3, 1969	182:00 - 184:00	8/115-116	3-111

# FLIGHT PLAN

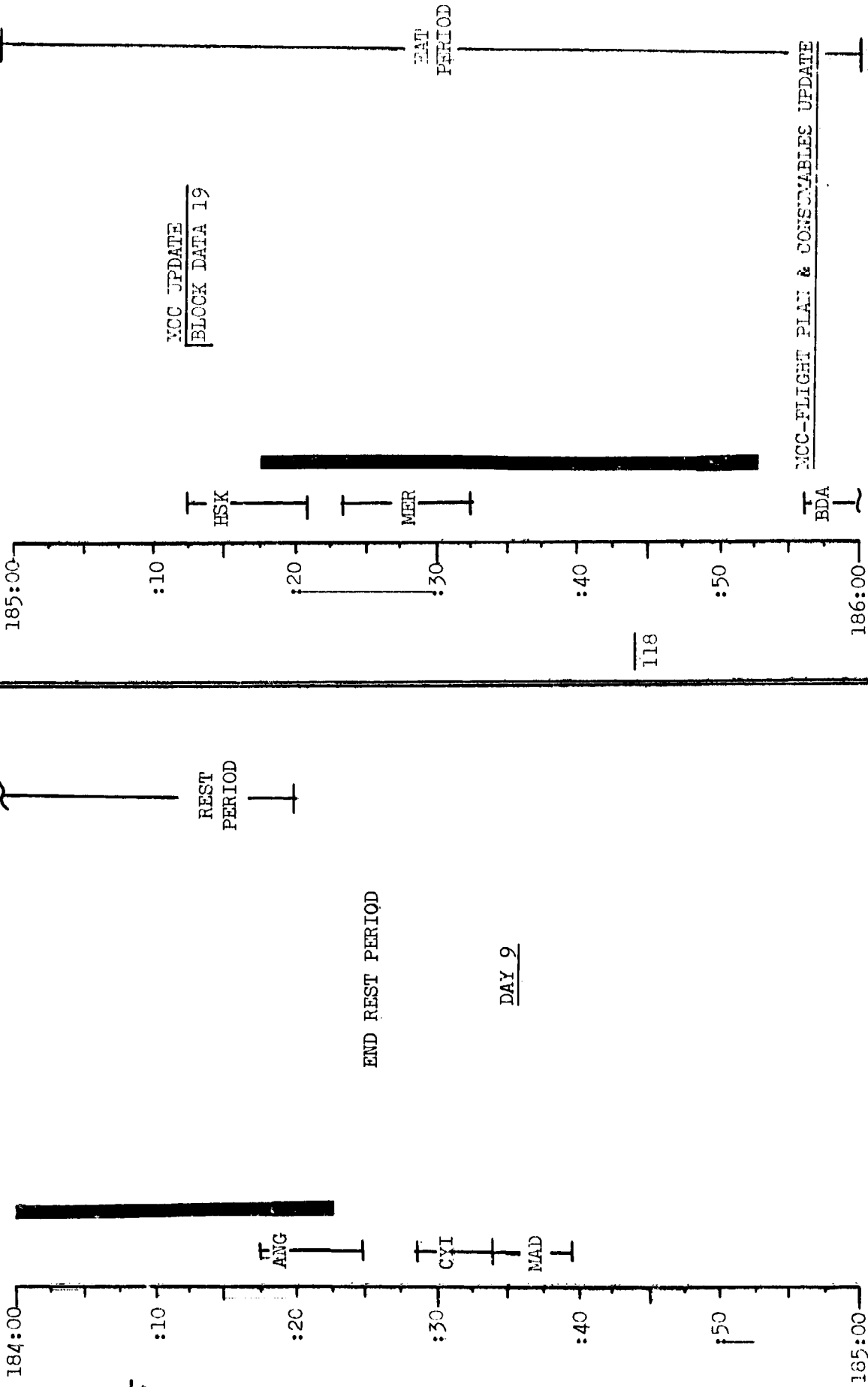

MISSION	EDITION	DATE	TIME	DAY/REV	PAGE
APOLLO 9	FINAL	FEBRUARY 3, 1969	184:00 - 186:00	8-9/116-118	3-112

# FLIGHT PLAN

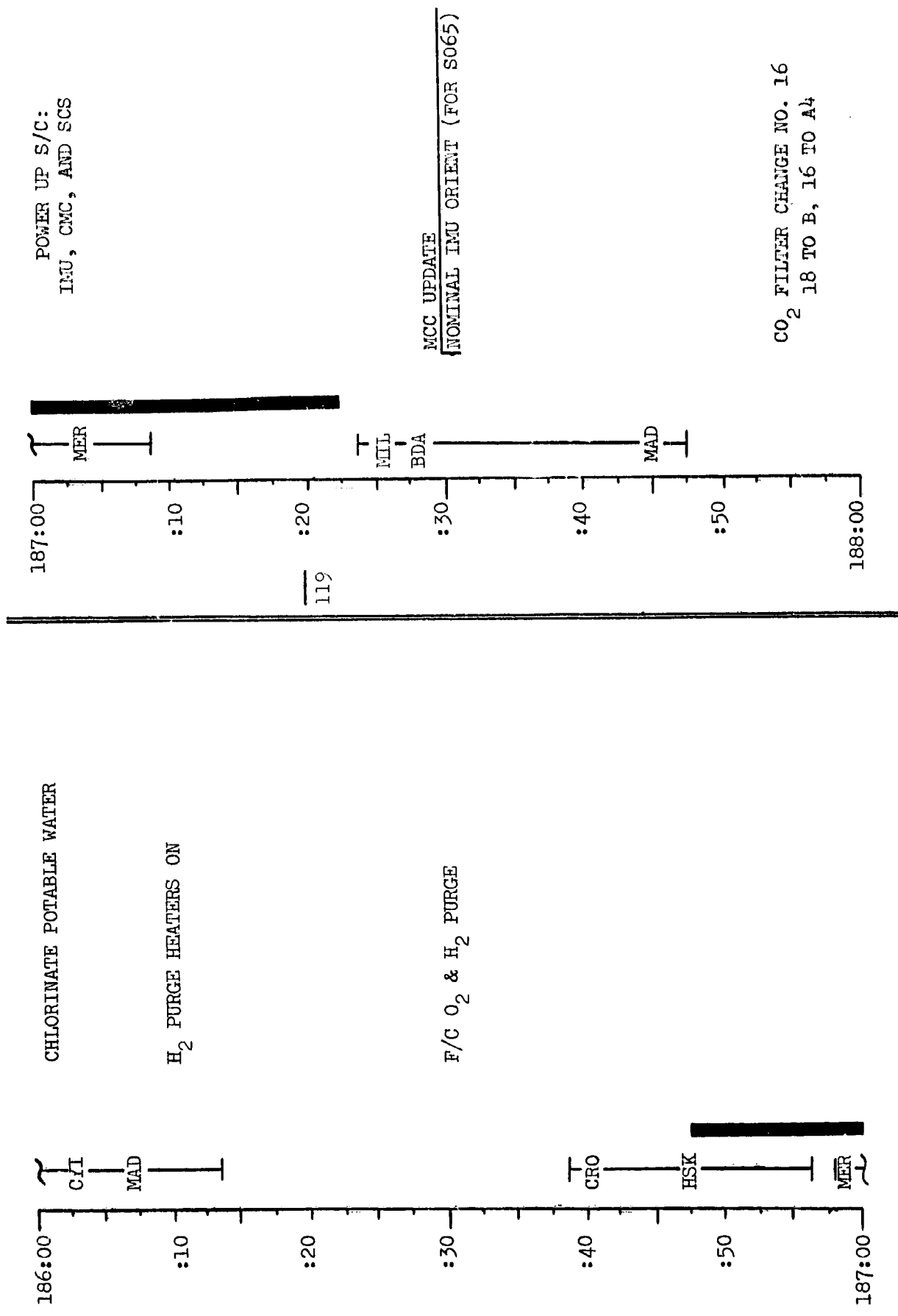

MISSION	EDITION	DATE	TIME	DAY/REV	PAGE
APOLLO 9	FINAL	FEBRUARY 3, 1969	186:00 - 188:00	9/118-119	3-113

# FLIGHT PLAN

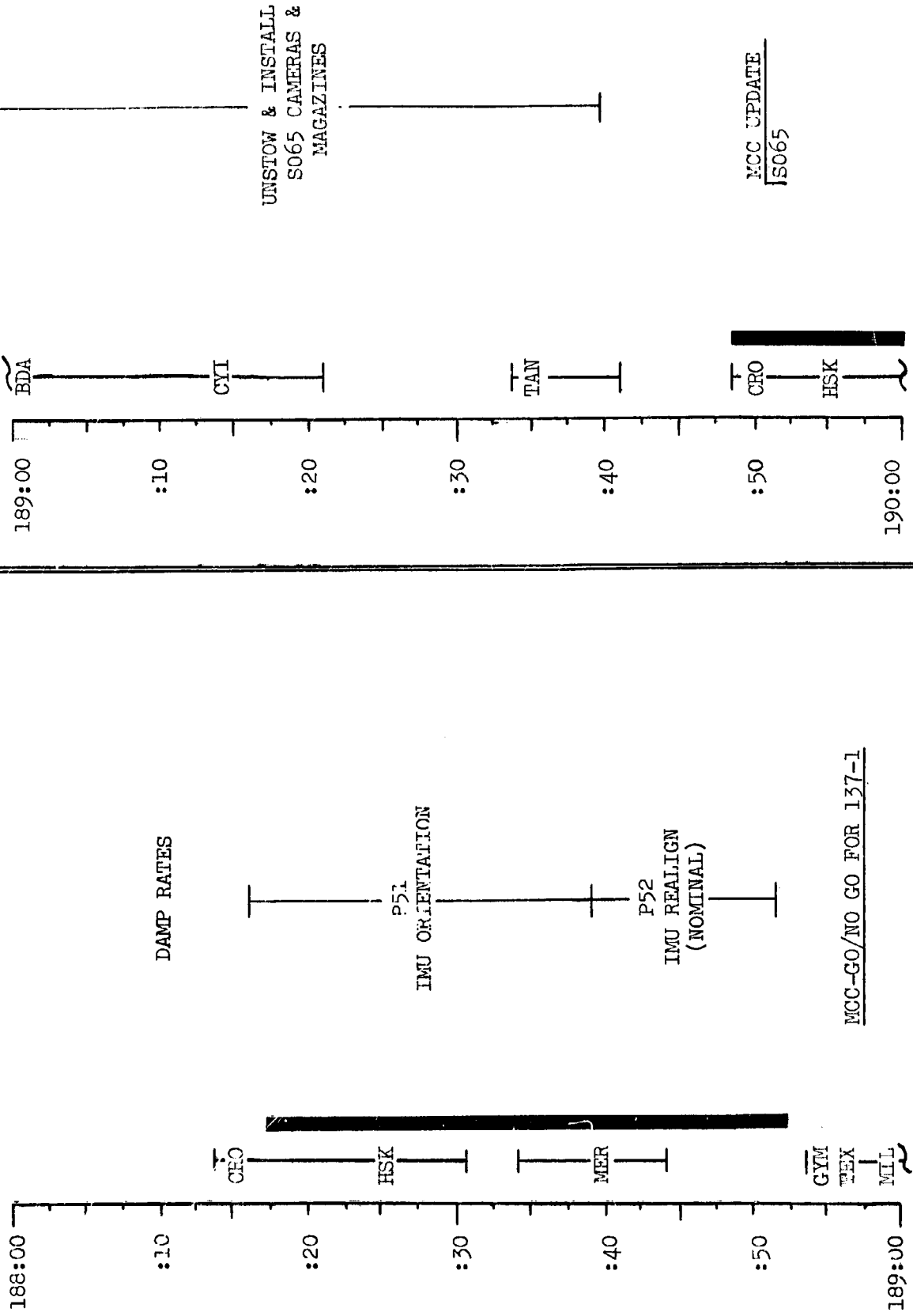

MISSION	EDITION	DATE	TIME	DR:/REV	PAGE
APOLLO 9	FINAL	FEBRUARY 3, 1969	188:00 - 190:00	9/119-120	3-114

# FLIGHT PLAN

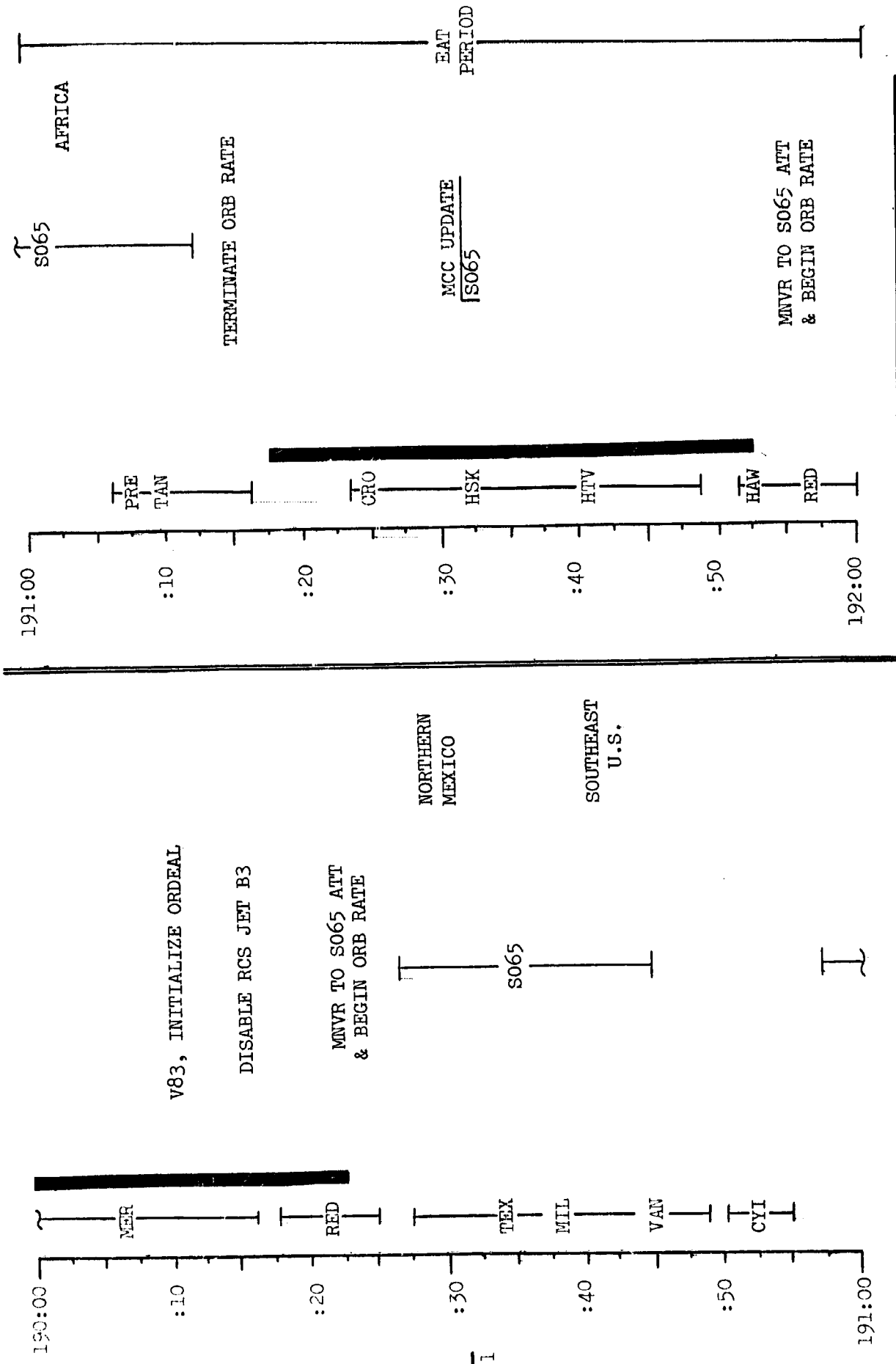

MISSION	EDITION	DATE	TIME	DAY/REV	PAGE
APOLLO 9	FINAL	FEBRUARY 3, 1969	190:00 - 192:00	9/120-121	3-115

# FLIGHT PLAN

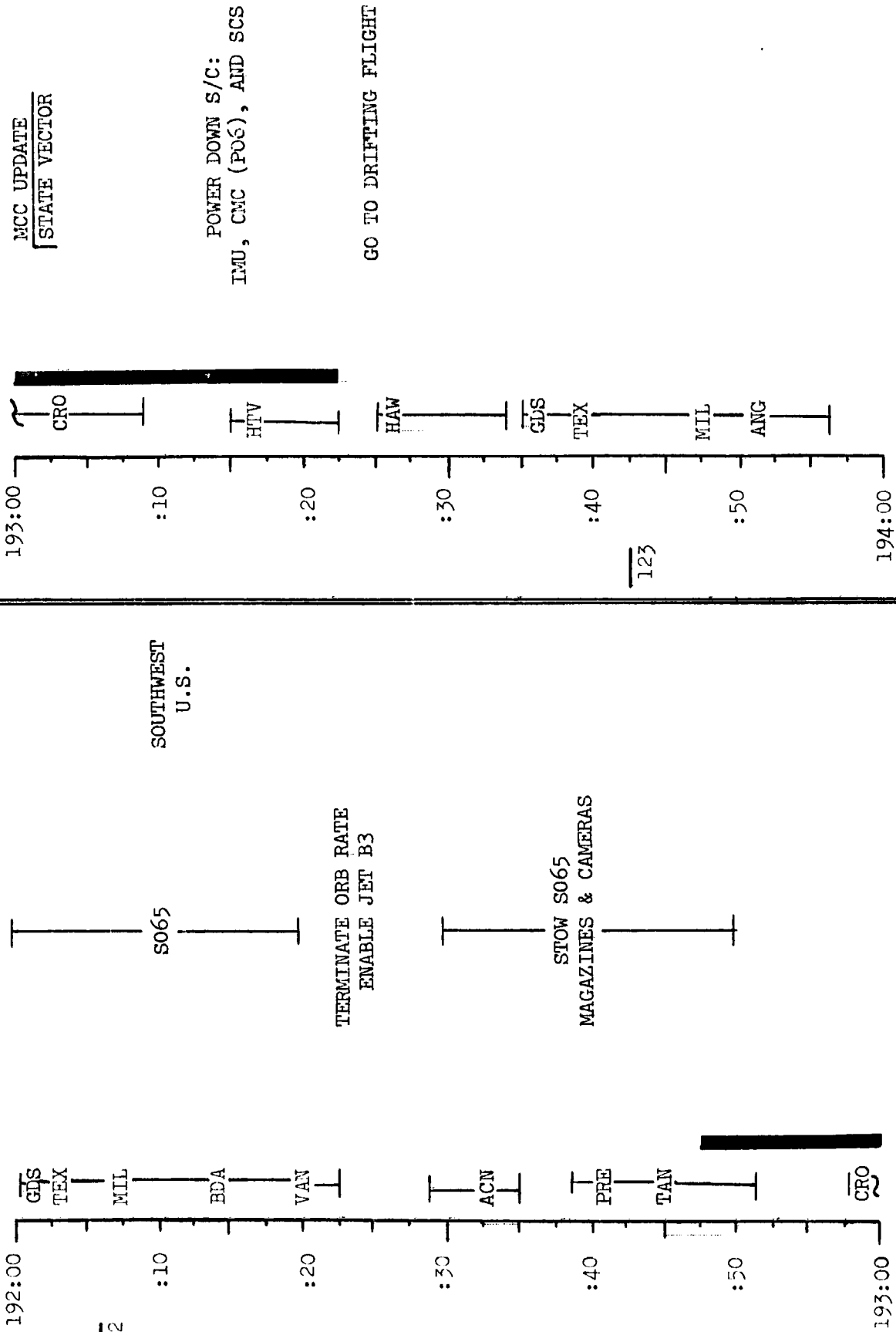

MISSION	EDITION	DATE	TIME	DAY/REV	PAGE
APOLLO 9	FINAL	FEBRUARY 3, 1969	192:00 - 194:00	9/121-123	3-116

# FLIGHT PLAN

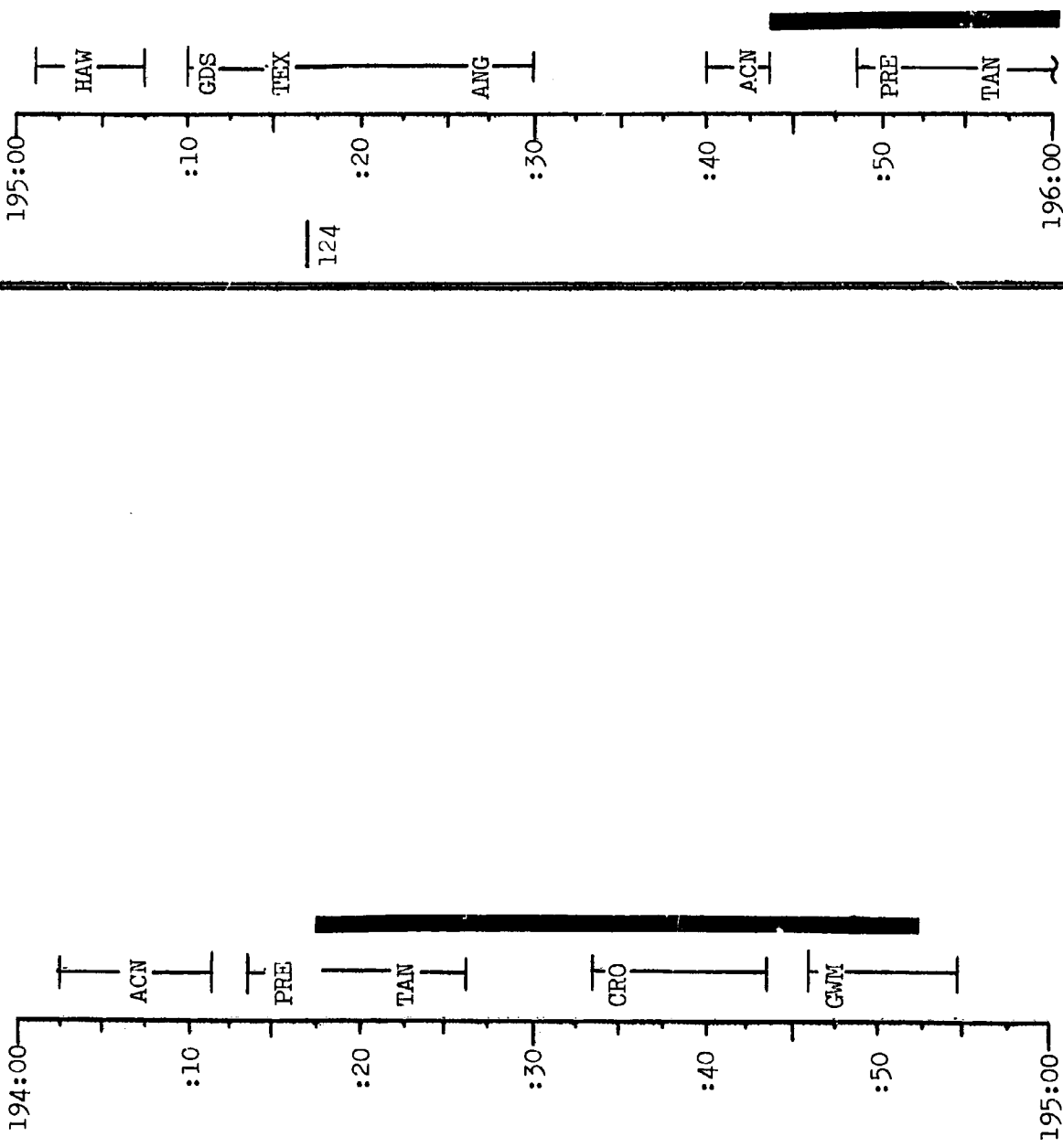

MISSION	EDITION	DATE	TIME	DAY/REV	PAGE
APOLLO 9	FINAL	FEBRUARY 3, 1969	194:00 - 196:00	9/123-124	3-117



# FLIGHT PLAN

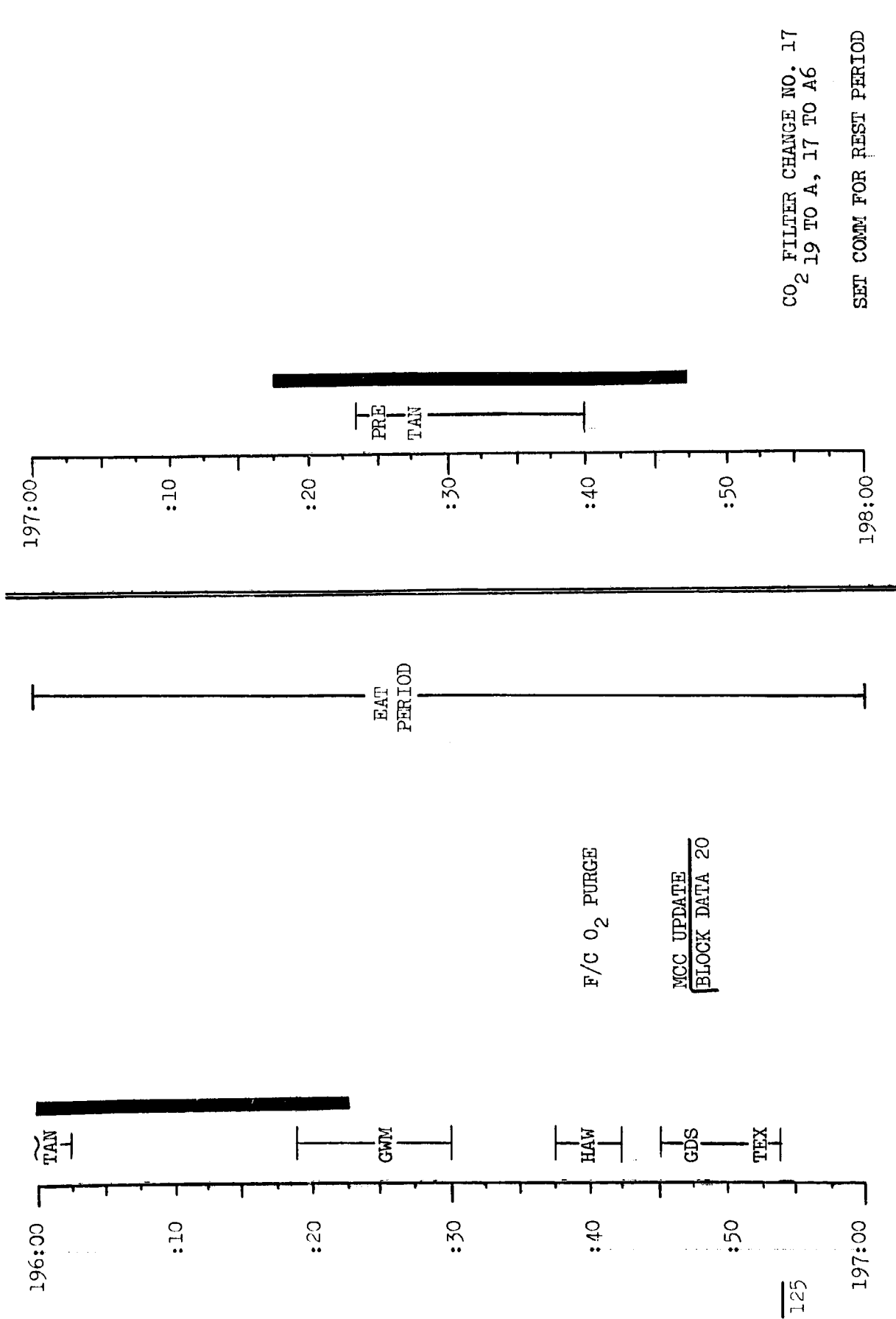

CO<sub>2</sub> FILTER CHANGE NO. 17  
 19 TO A, 17 TO A6

SET COMM FOR REST PERIOD

MISSION	EDITION	DATE	TIME	DAY/REV	PAGE
APOLLO 9	FINAL	FEBRUARY 3, 1969	196:00 - 198:00	9/124-125	3-118

# FLIGHT PLAN

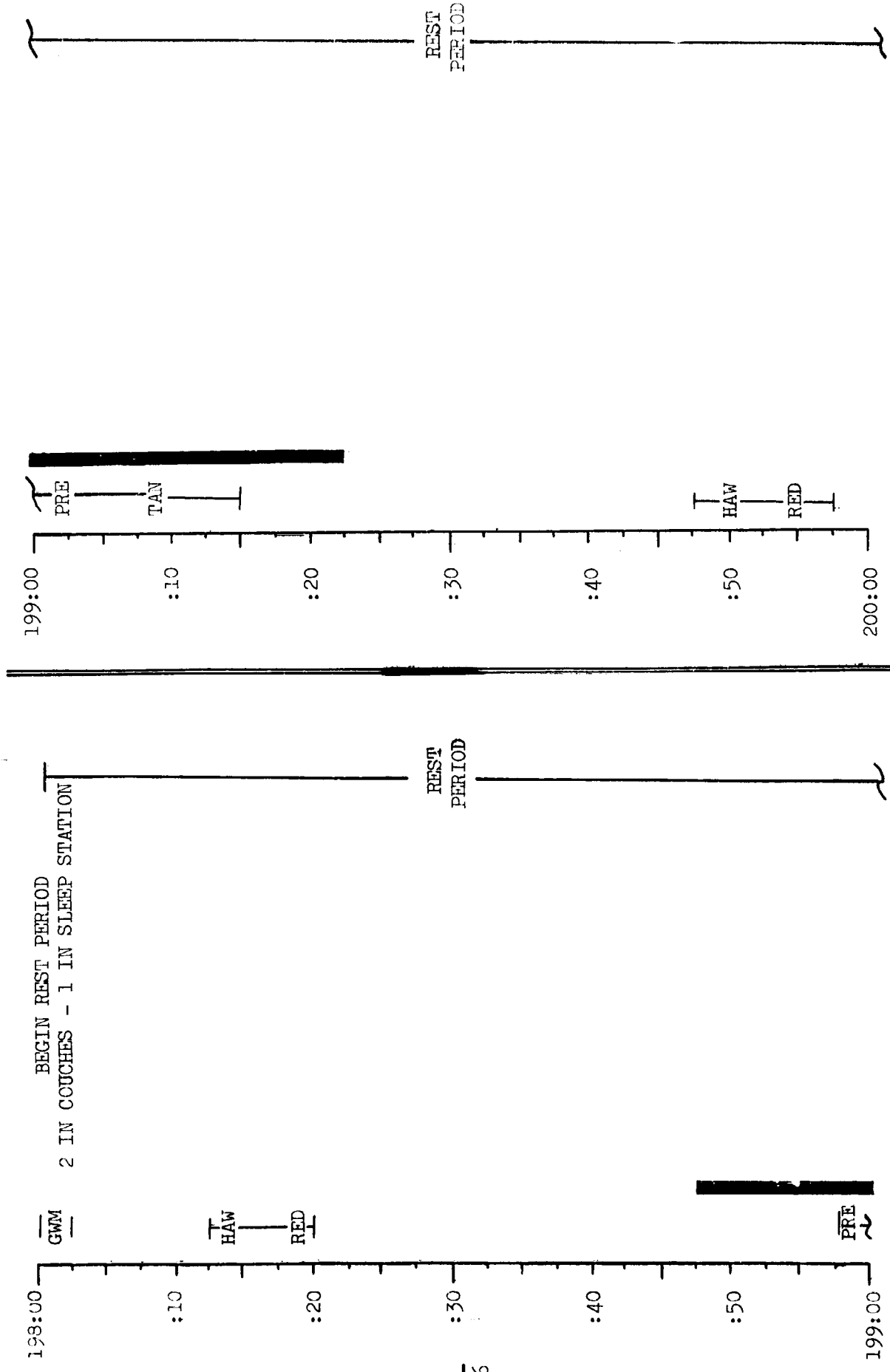

BEGIN REST PERIOD  
2 IN COUCHES - 1 IN SLEEP STATION

MISSION	EDITION	DATE	TIME	DAY/REV	PAGE
APOLLO 9	FINAL	FEBRUARY 3, 1969	198:00 - 200:00	9/125-126	3-119

# FLIGHT PLAN

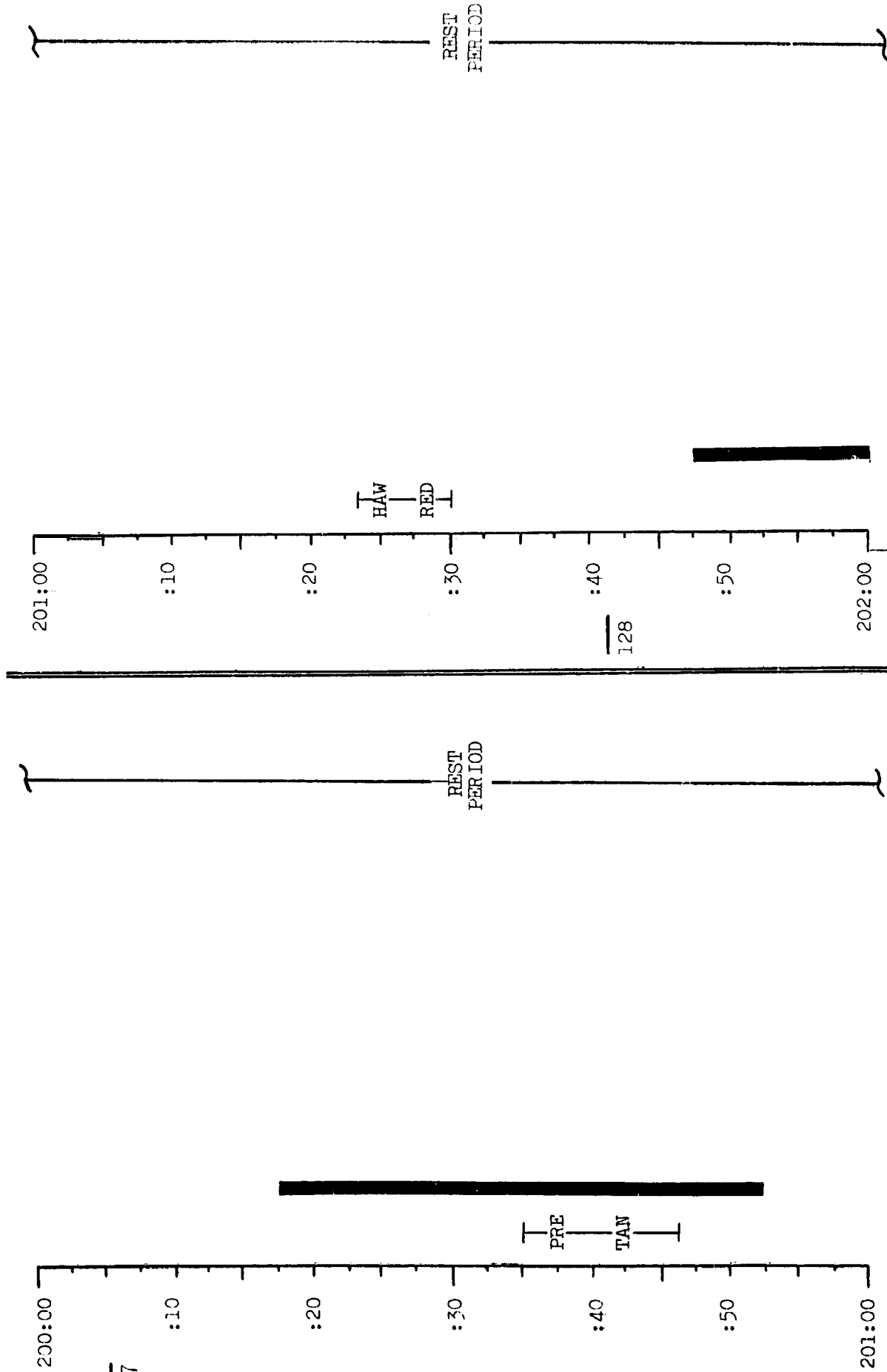

MISSION	EDITION	DATE	TIME	DAY/REV	PAGE
APOLLO 9	FINAL	FEBRUARY 3, 1969	200:00 - 202:00	9/126-128	3-120

# FLIGHT PLAN

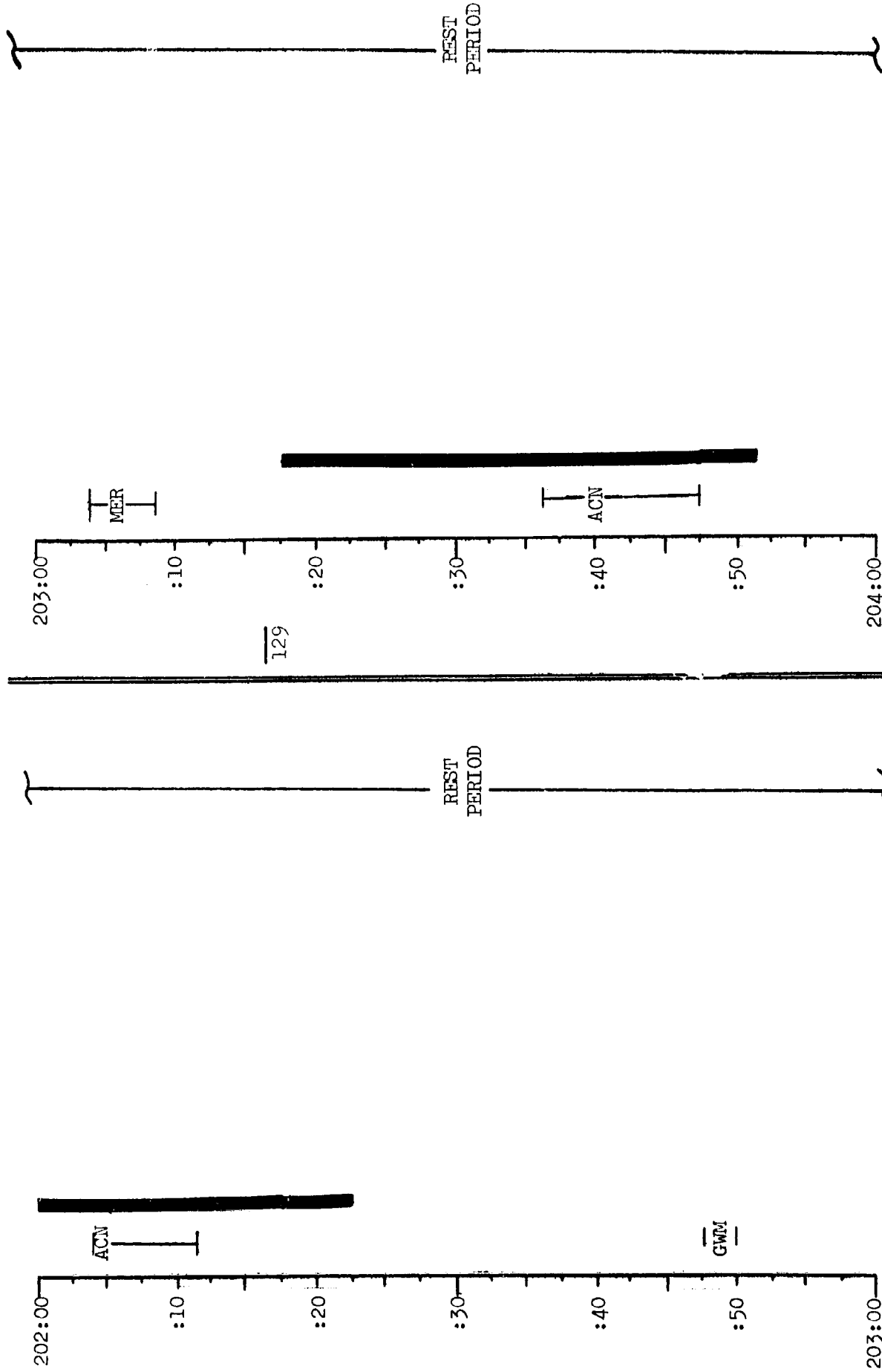

MISSION	EDITION	DATE	TIME	DAY/REV	PAGE
APOLLO 9	FINAL	FEBRUARY 3, 1969	202:00 - 204:00	9/128-129	3-121

# FLIGHT PLAN

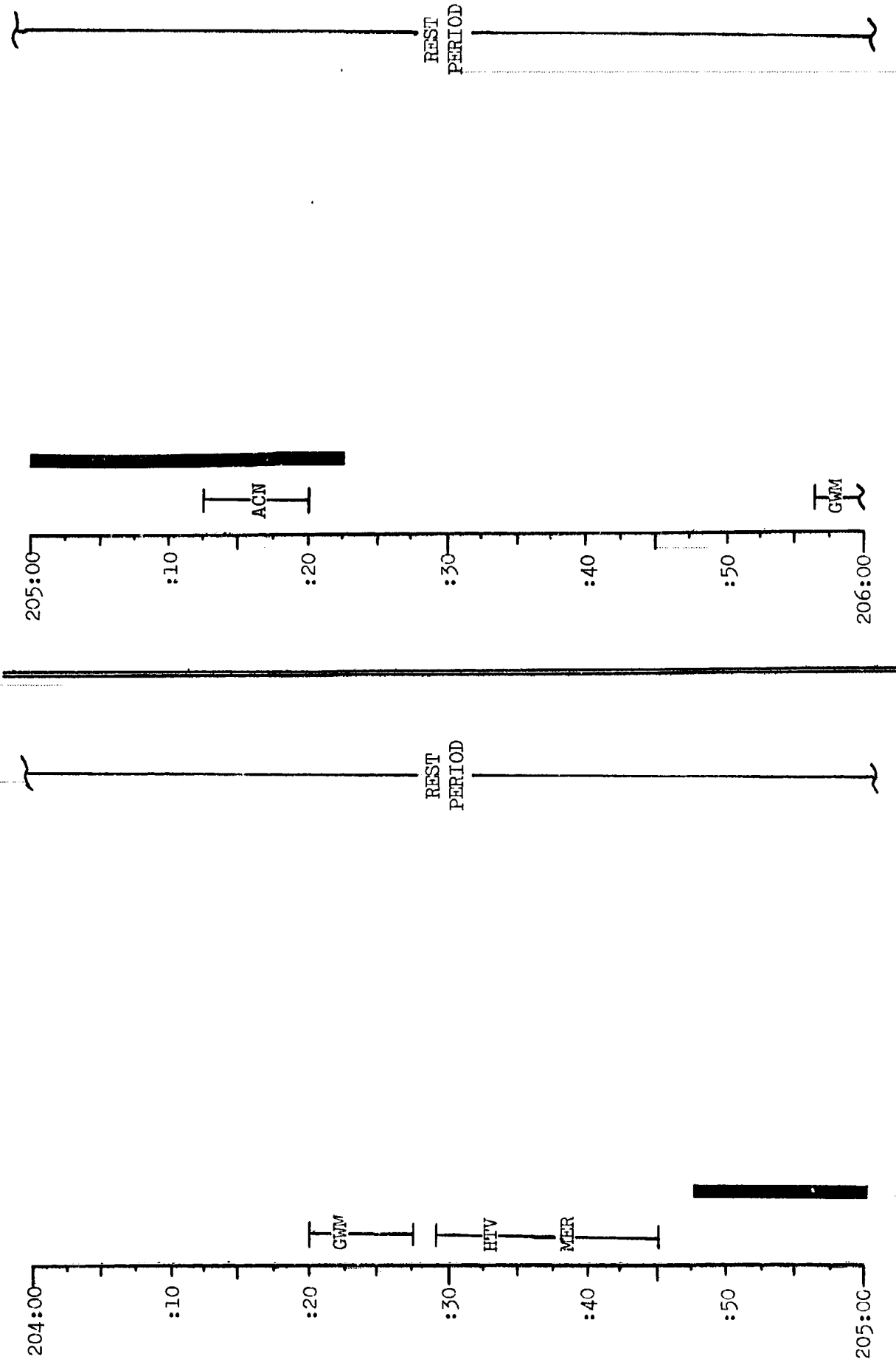

MISSION	EDITION	DATE	TIME	DAY/REV	PAGE
APOLLO 9	FINAL	FEBRUARY 3, 1969	204:00 - 206:00	9/129-130	3-122

# FLIGHT PLAN

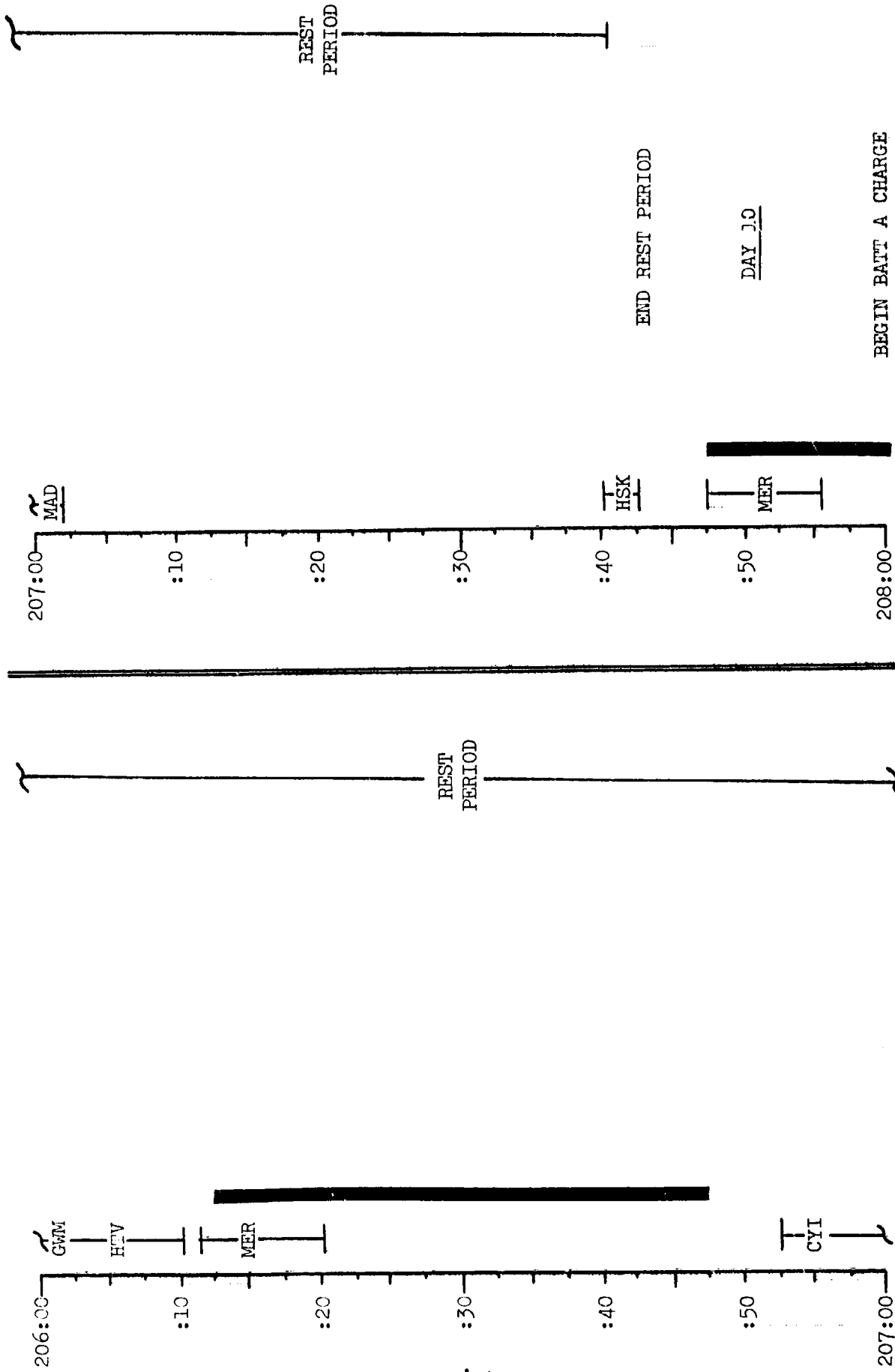

BEGIN BATT A CHARGE

MISSION	ERSTION	DATE	TIME	DAY/REV	PAGE
APOLLO 9	FINAL	FEBRUARY 3, 1969	206:00 - 208:00	9/130-131	3-123

# FLIGHT PLAN



152



133

CHLORINATE POTABLE WATER

F/C O<sub>2</sub> PURGE

MCC UPDATE  
BLOCK DATA 21

MCC-FLIGHT PLAN & CONSUMABLES UPDATE

MISSION	EDITION	DATE	TIME	DAY/REV	PAGE
APOLLO 9	FINAL	FEBRUARY 3, 1969	208:00 - 210:00	10/150-133	3-124

# FLIGHT PLAN

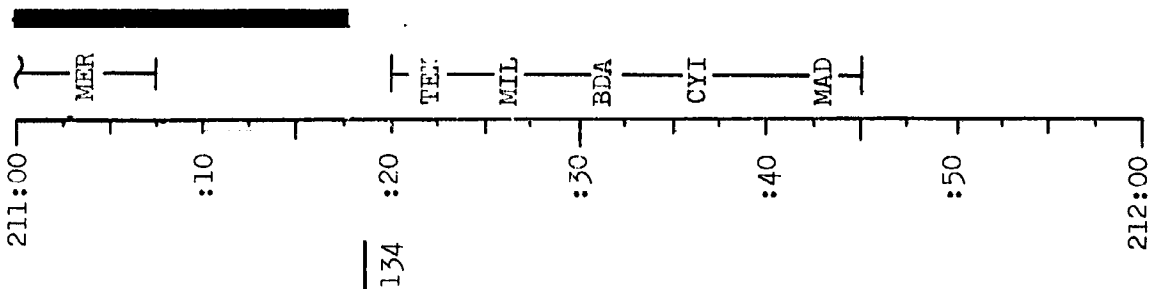
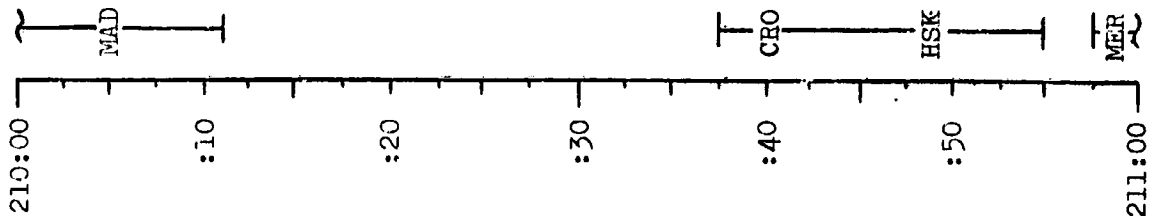

POWER UP S/C:  
IMU, CMC, AND SCS

MCC UPDATE  
NOMINAL IMU ORIENT (FOR S065)

CO<sub>2</sub> FILTER CHANGE NO. 18  
20 TO B, 18 TO A6

MISSION	EDITION	DATE	TIME	DAY/REV	PAGE
APOLLO 9	FINAL	FEBRUARY 3, 1969	210:00 - 212:00	10/133-134	3-125



# FLIGHT PLAN

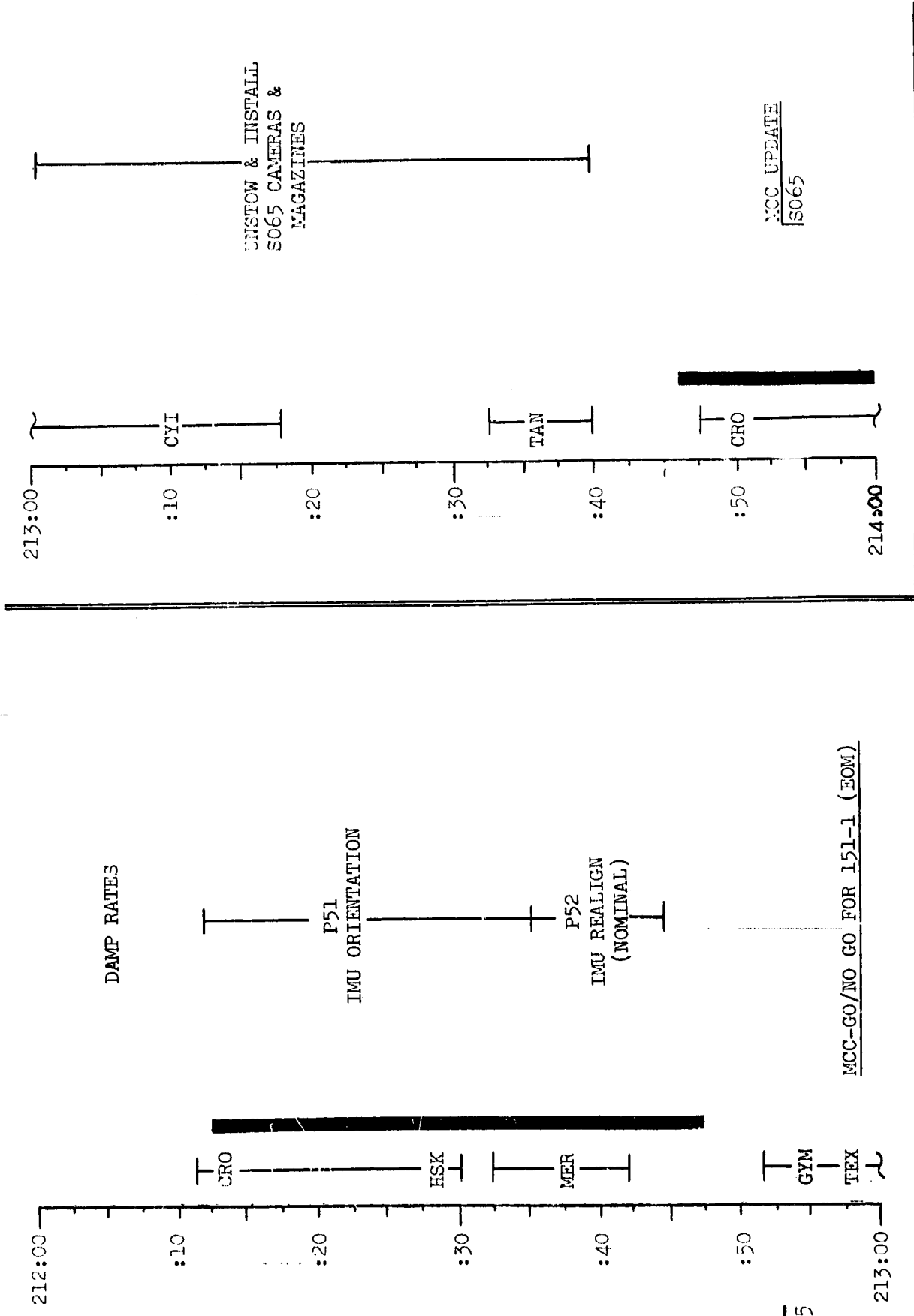

MISSION	EDITION	DATE	TIME	DAY/REV	PAGE
APOLLO 9	FINAL	FEBRUARY 3, 1969	212:00 - 214:00	10, 134-135	3-126

# FLIGHT PLAN

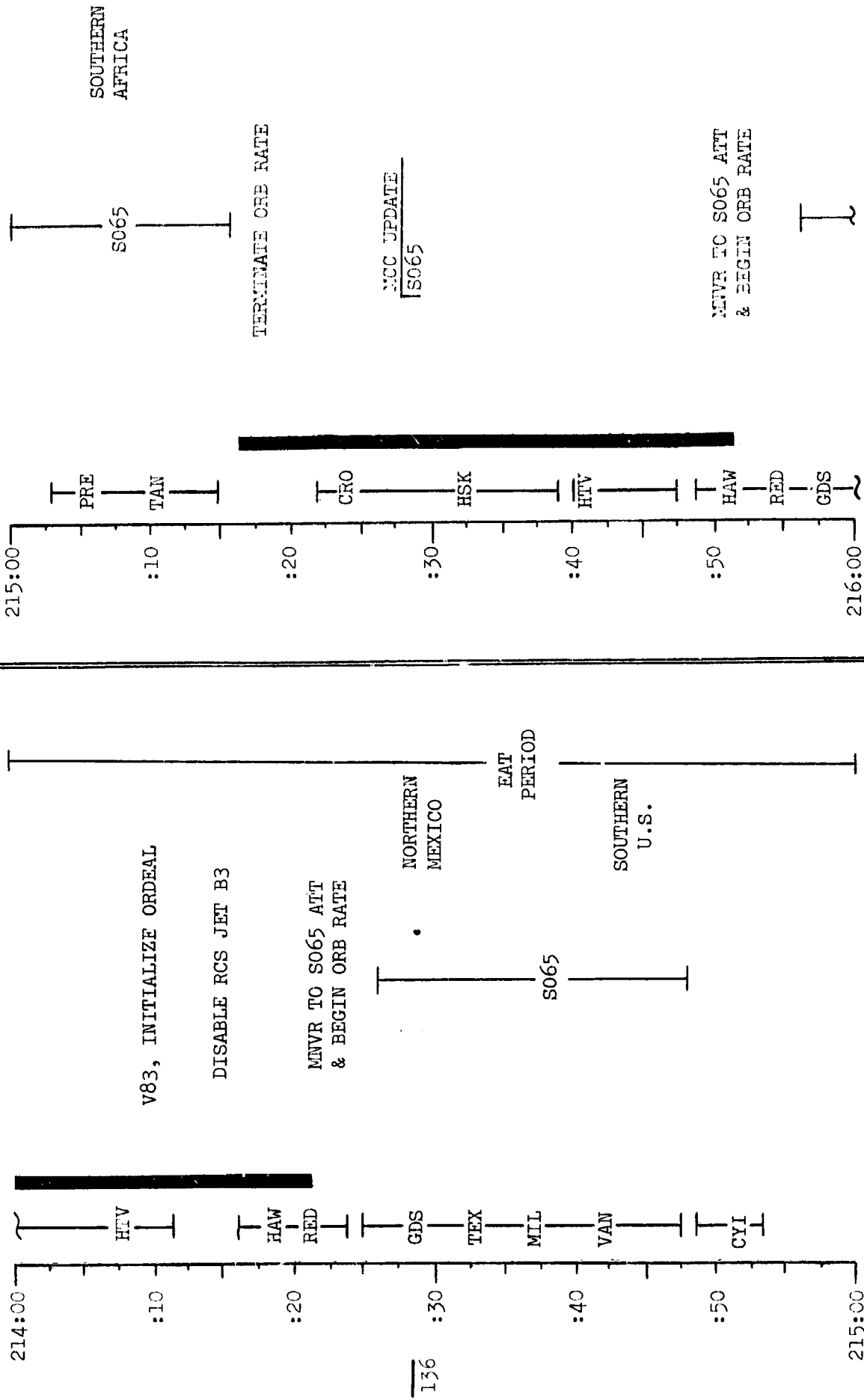

MISSION	EDITION	DATE	TIME	DAY/REV	PAGE
APOLLO 9	FINAL	FEBRUARY 3, 1969	214:00 - 216:00	10/135-156	3-127

# FLIGHT PLAN

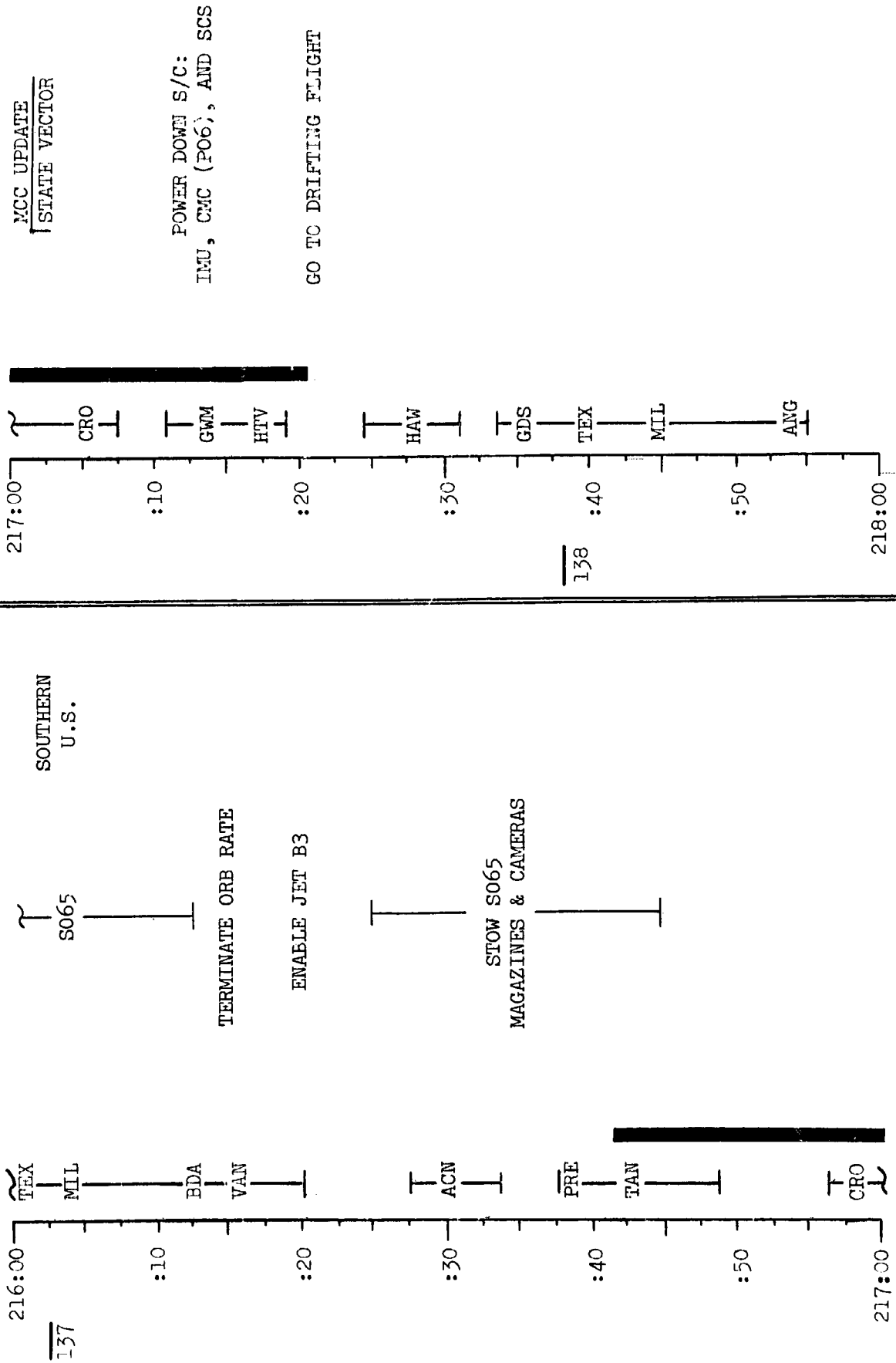

137

138

MISSION	EDITION	DATE	TIME	DAY/REV	PAGE
APOLLO 9	FINAL	FEBRUARY 3, 1969	216:00 - 218:00	10/136-138	3-128

# FLIGHT PLAN

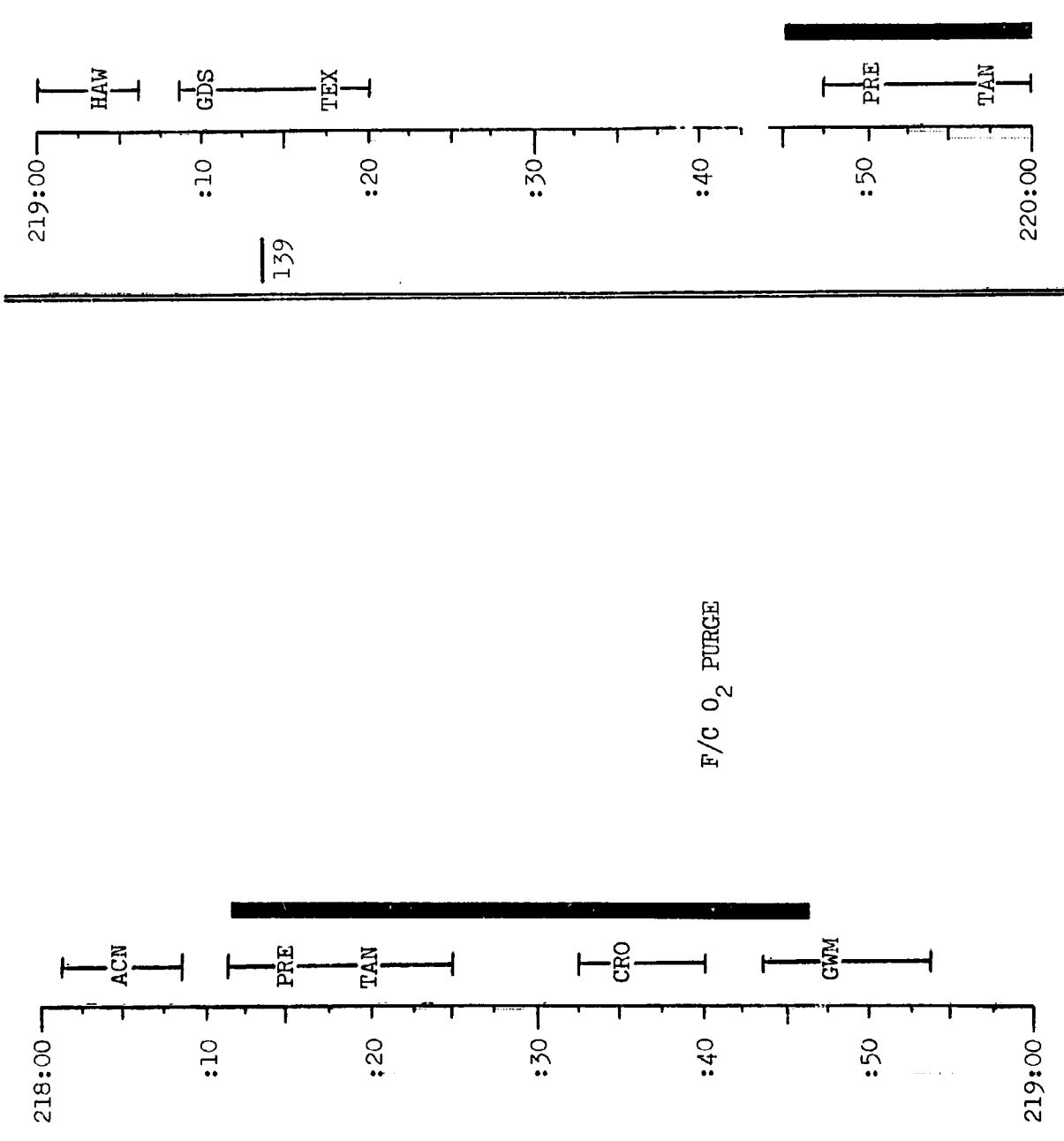

MISSION	EDITION	DATE	TIME	DAY/REV	PAGE
APOLLO 9	FINAL	FEBRUARY 3, 1. 69	218:00 - 220:00	10/138-139	3-129

# FLIGHT PLAN

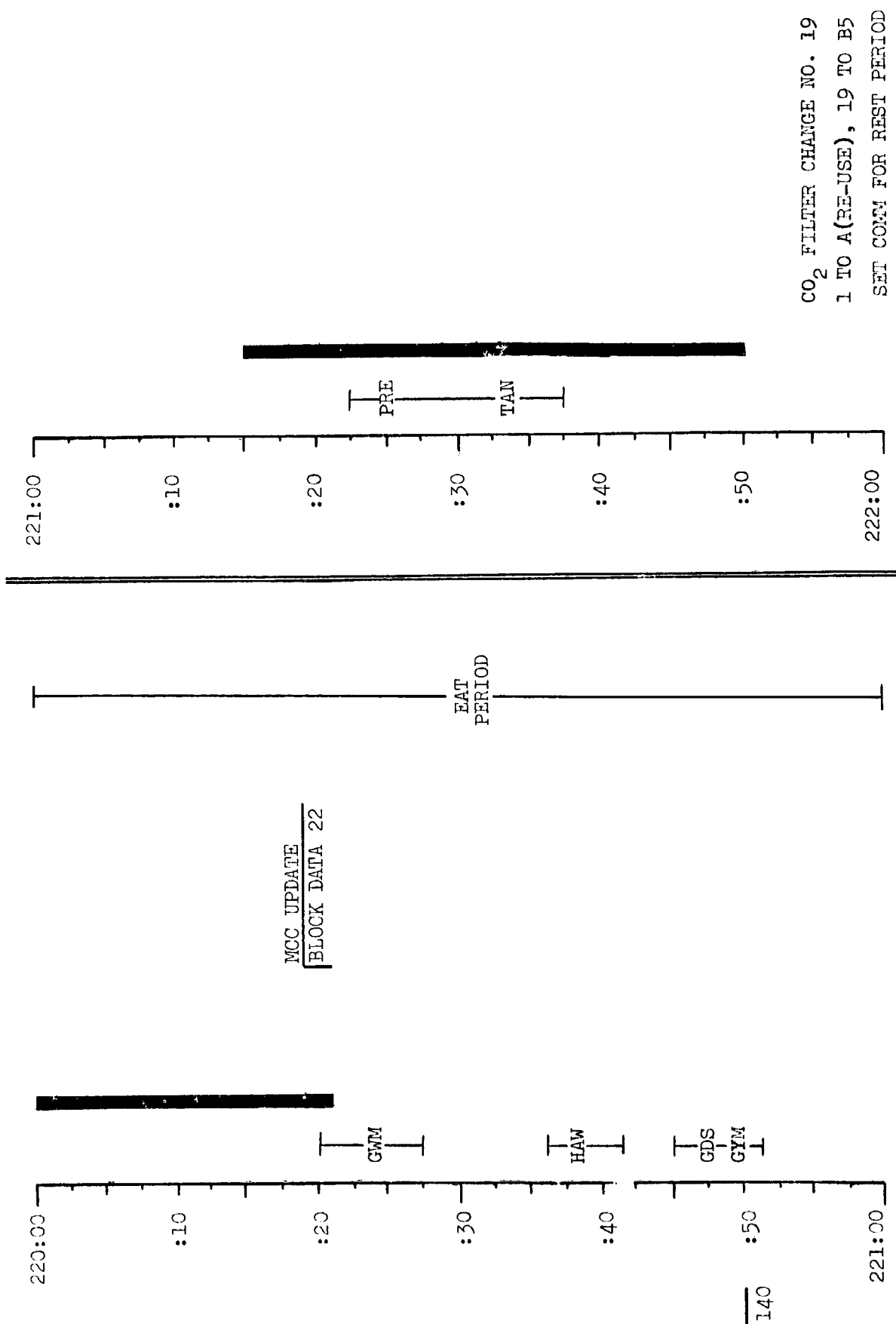

CO<sub>2</sub> FILTER CHANGE NO. 19  
 1 TO A(RE-USE), 19 TO B5  
 SET COM FOR REST PERIOD

140

MISSION	EDITION	DATE	TIME	DAY/REV	PAGE
APOLLO 9	FINAL	FEBRUARY 3, 1969	220:00 - 222:00	10/139-140	3-130

# FLIGHT PLAN

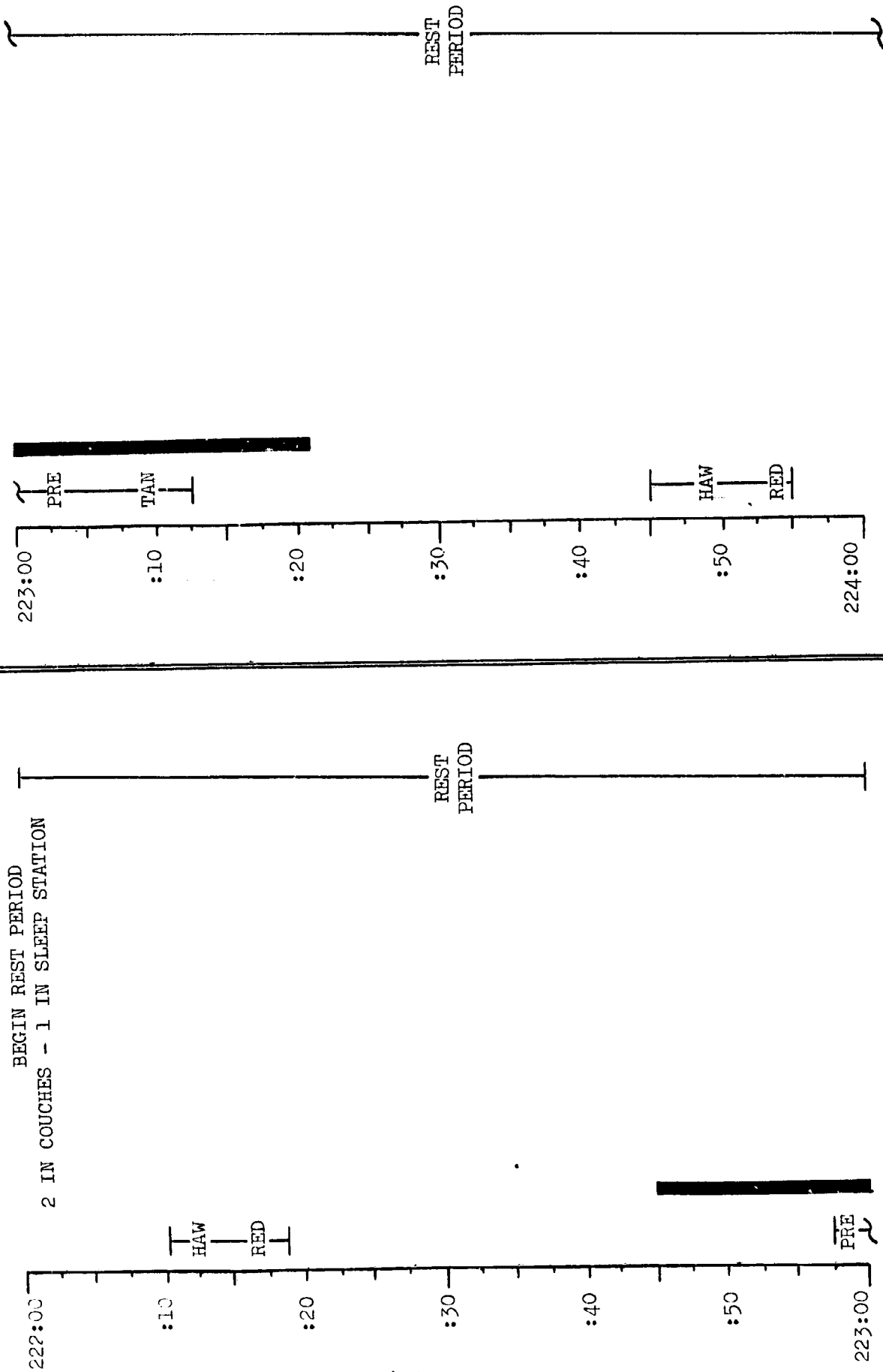

141

MISSION	EDITION	DATE	TIME	DAY/REV	PAGE
APOLLO 9	FINAL	FEBRUARY 3, 1969	222:00 - 224:00	10/140-141	3-131

# FLIGHT PLAN

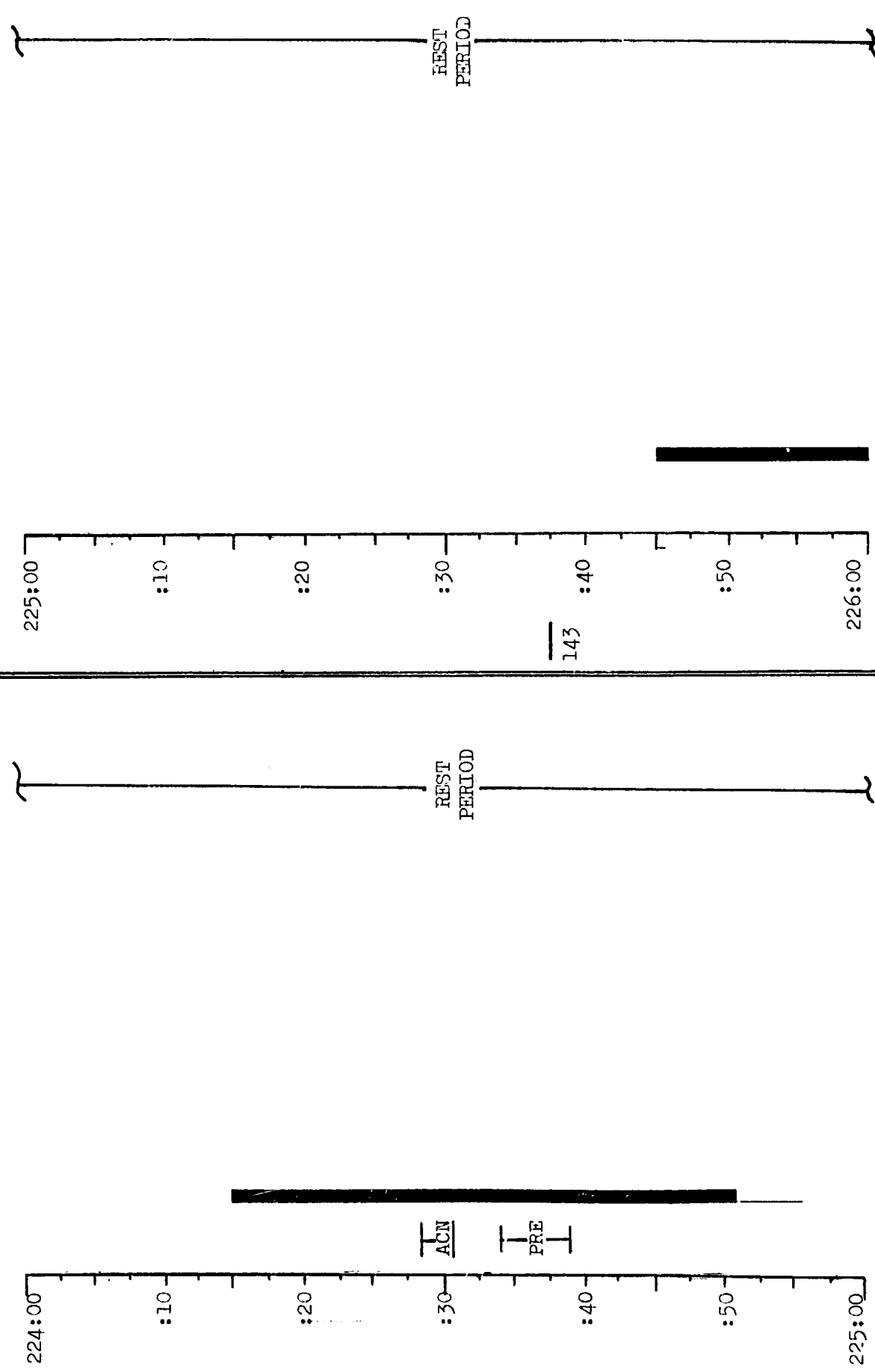

MISSION	EDITION	DATE	TIME	DAY/REV	PAGE
APOLLO 9	FINAL	FEBRUARY 3, 1969	224:00 - 226:00	10/142-143	3-132

# FLIGHT PLAN

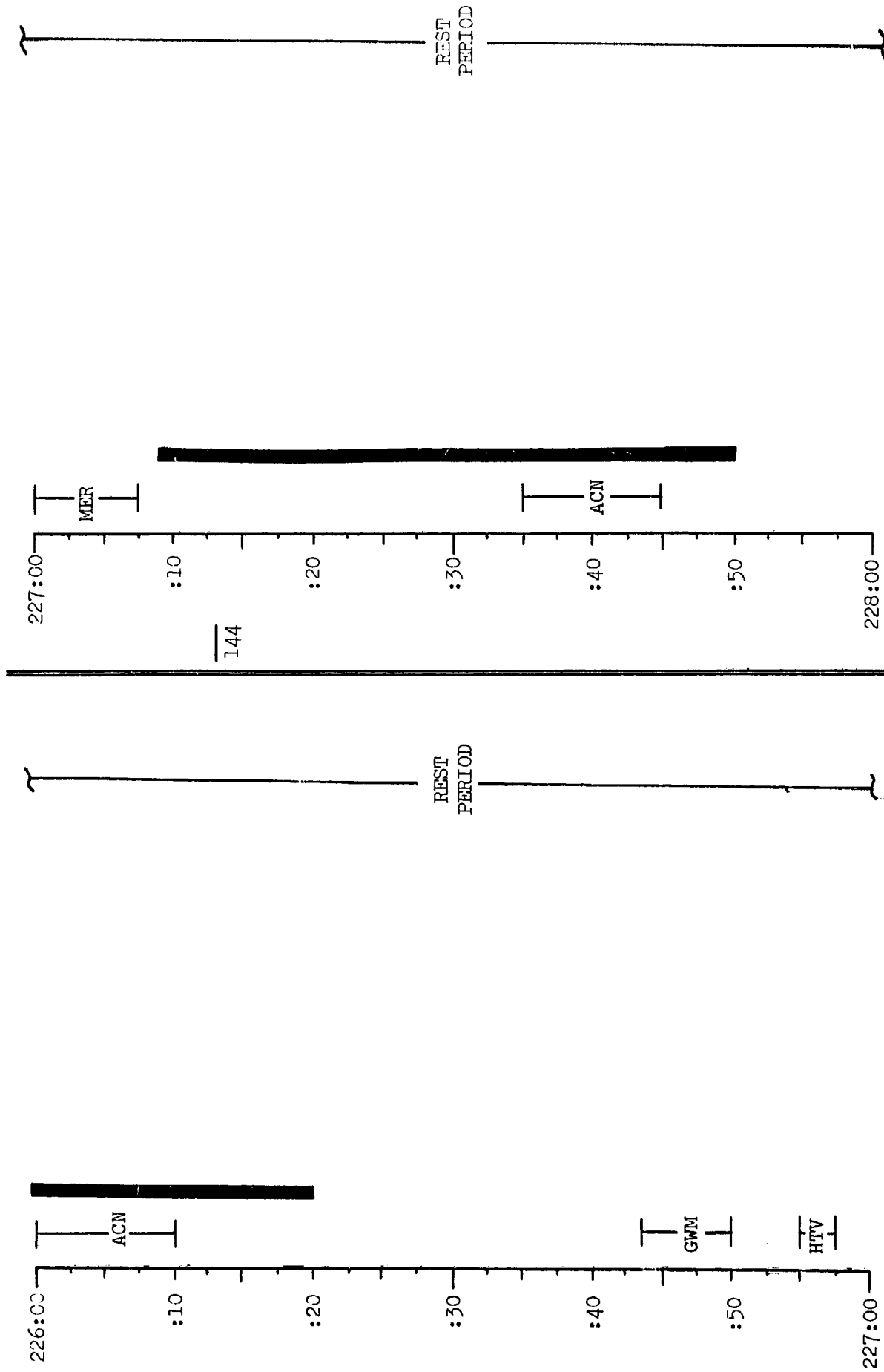

MISSION	EDITION	DATE	TIME	DAY/REV	PAGE
APOLLO 9	FINAL	FEBRUARY 3, 1969	226:00 - 228:00	10/143-144	3-133



# FLIGHT PLAN

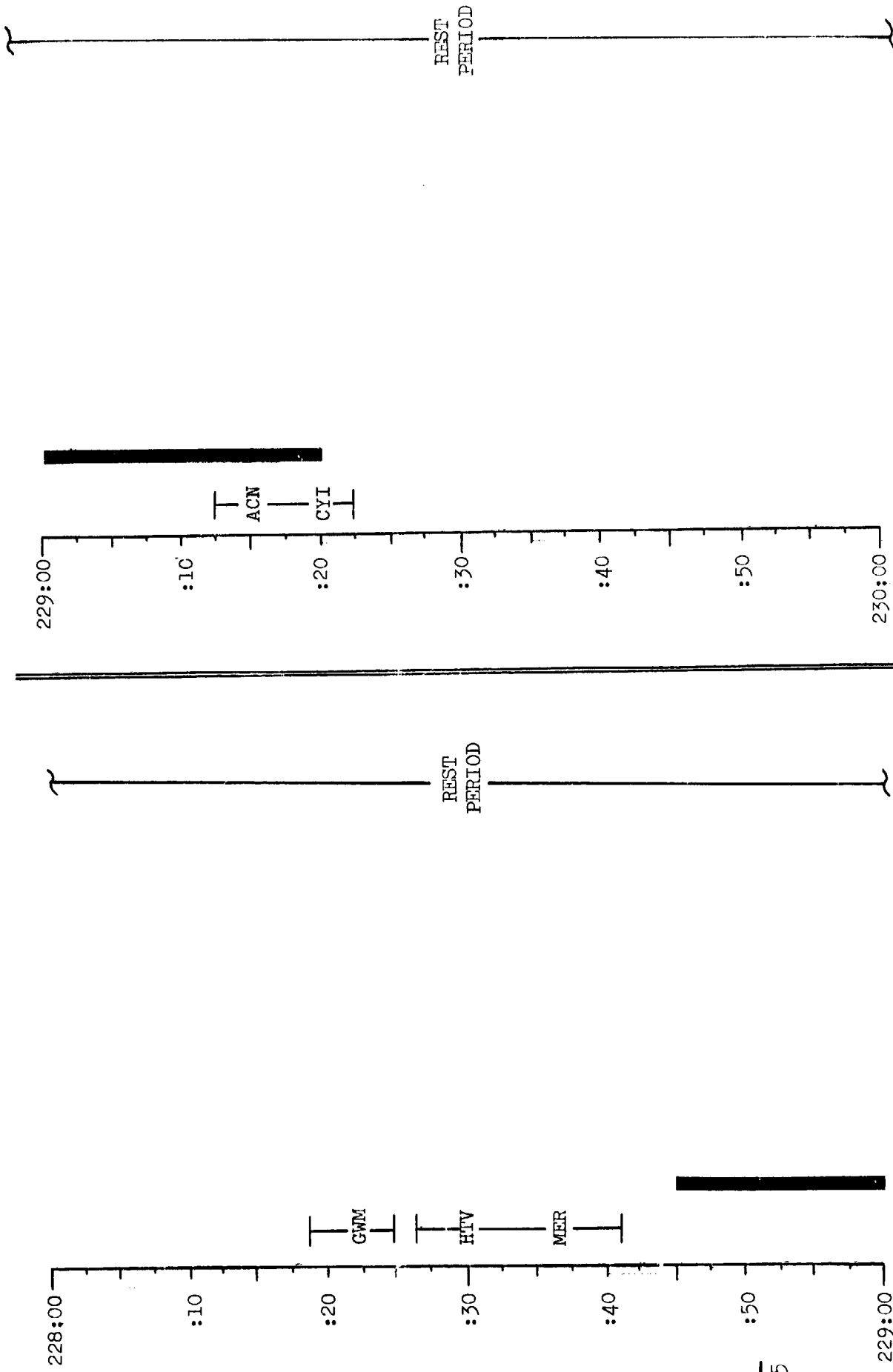

145

MISSION	EDITION	DATE	TIME	DAY/REV	PAGE
APOLLO 9	FINAL	FEBRUARY 3, 1969	228:00 - 230:00	10/144-145	3-134

# FLIGHT PLAN

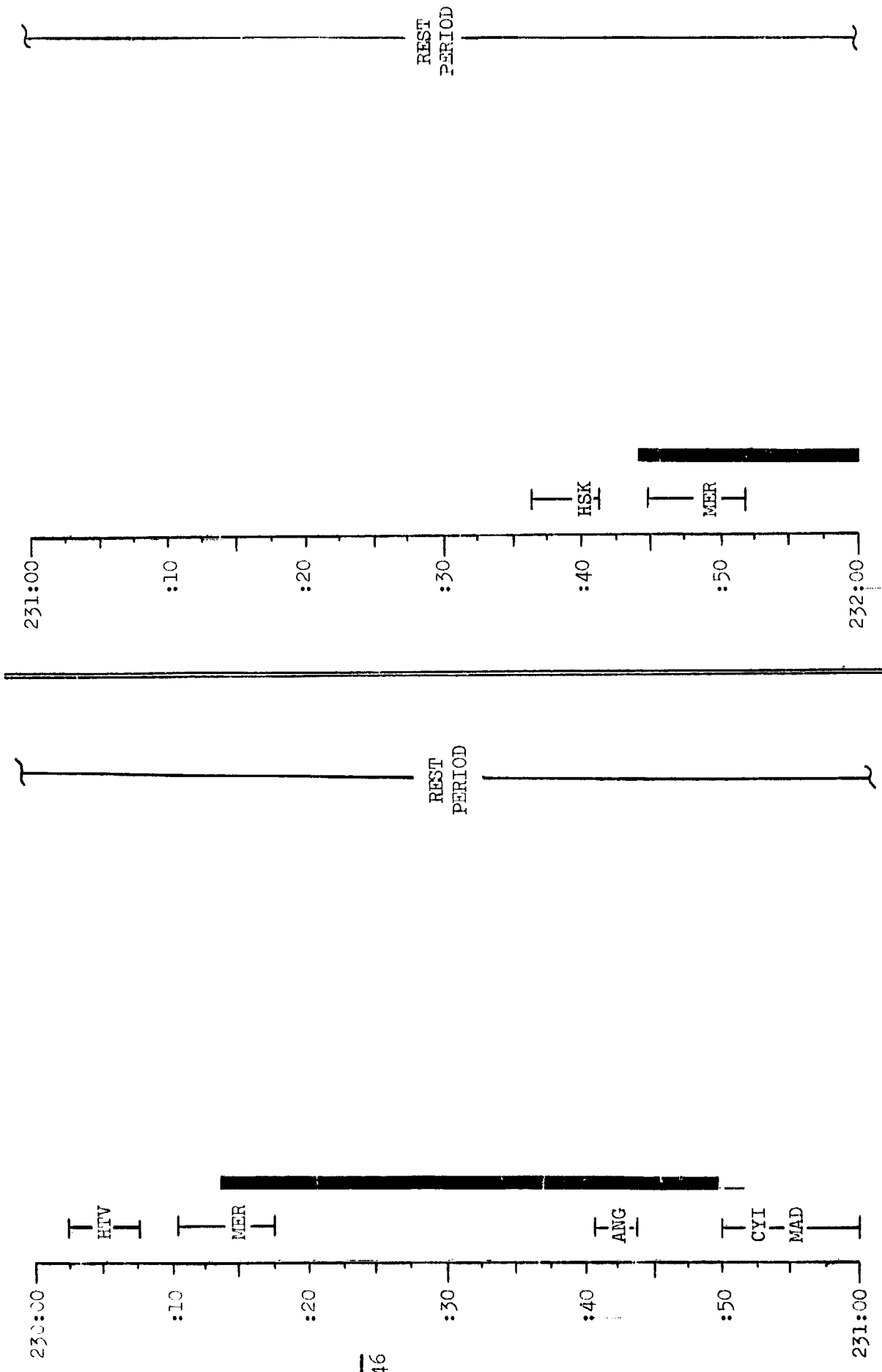

146

MISSION	EDITION	DATE	TIME	DAY/REV	PAGE
APOLLO 9	FINAL	FEBRUARY 3, 1969	230:00 - 232:00	10-11-145-146	3-135

# FLIGHT PLAN

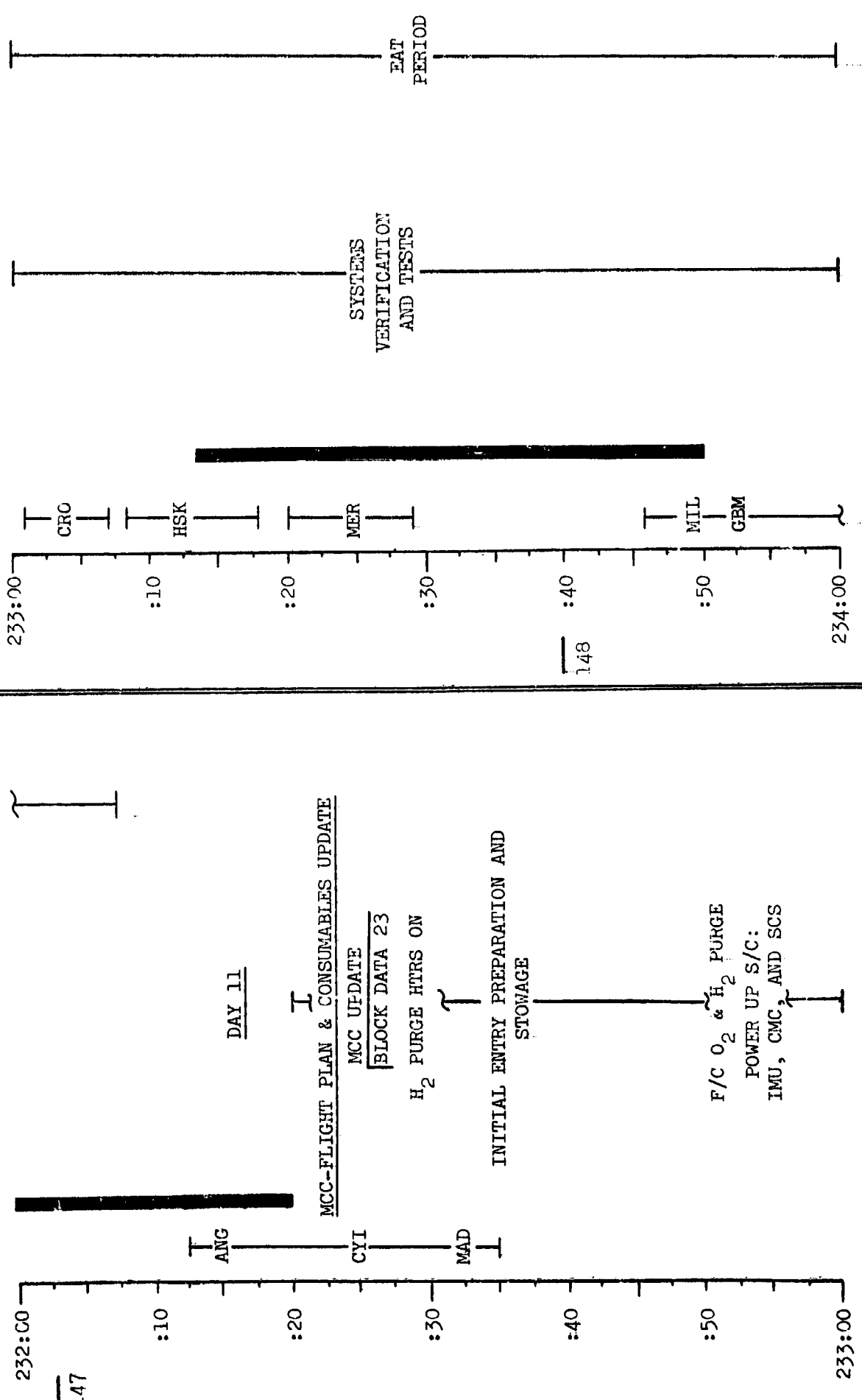

MISSION	EDITION	DATE	TIME	DAY/REV	PAGE
APOLLO 9	FINAL	FEBRUARY 3, 1969	232:00 - 234:00	11/146-148	3-136

# FLIGHT PLAN

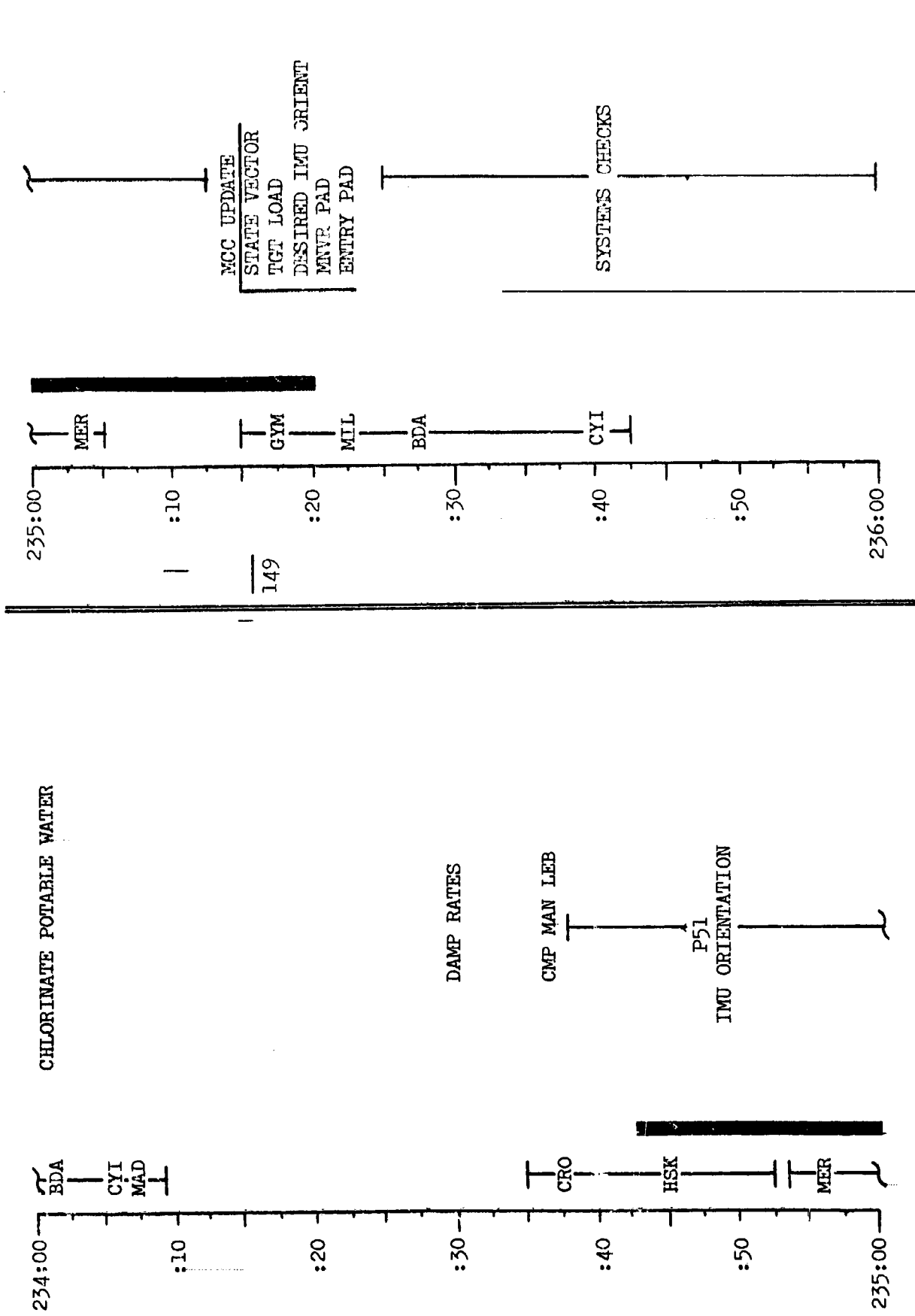

MISSION	EDITION	DATE	TIME	DAY/REV	PAGE
APOLLO 9	FINAL	FEBRUARY 3, 1969	234:00 - 236:00	11/148-149	3-137

# FLIGHT PLAN

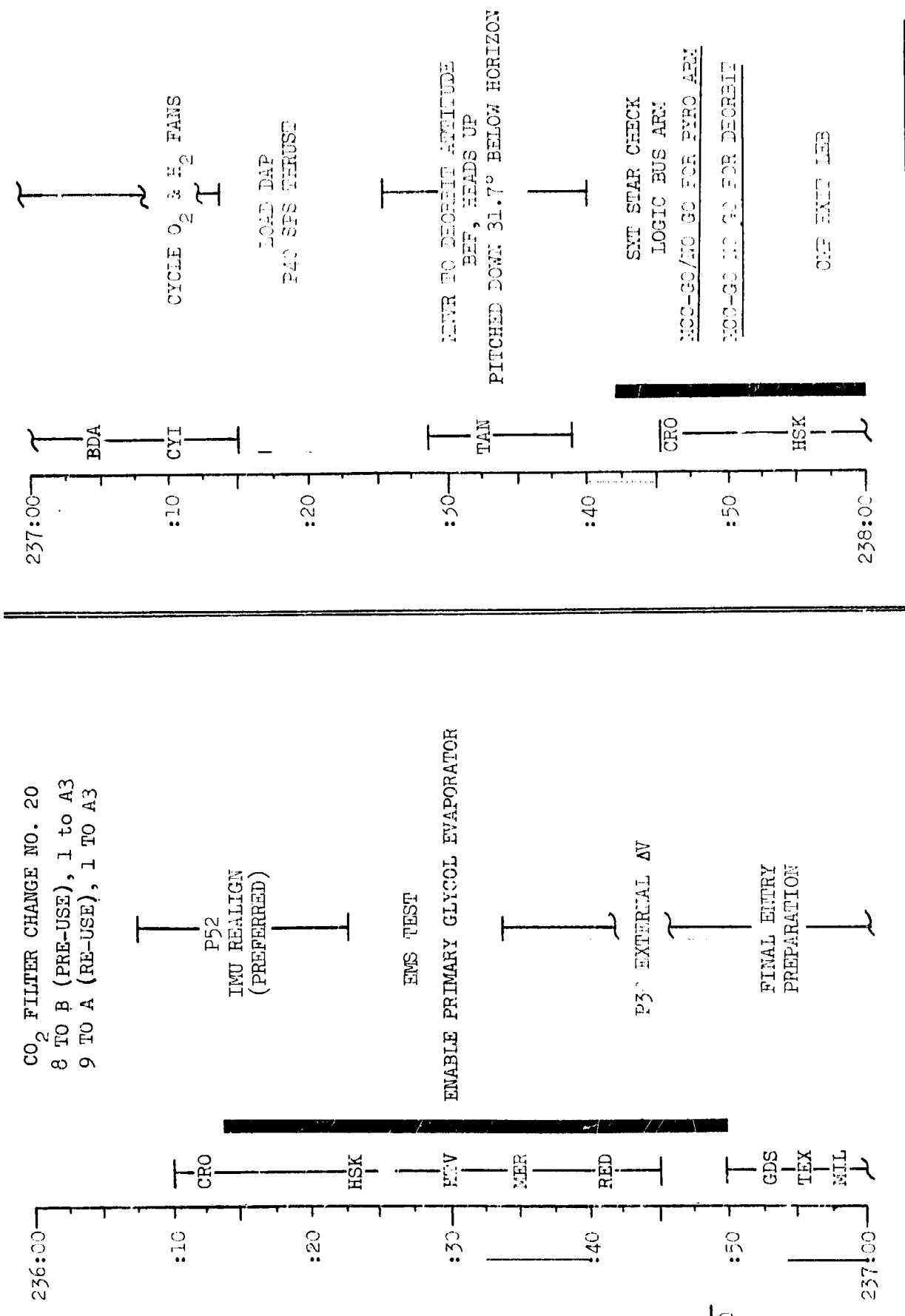

MISSION	EDITION	DATE	TIME	DAY/REV	PAGE
APOLLO 9	FINAL	FEBRUARY 3, 1969	236:00 - 238:00	11 11-151	3-138

# FLIGHT PLAN

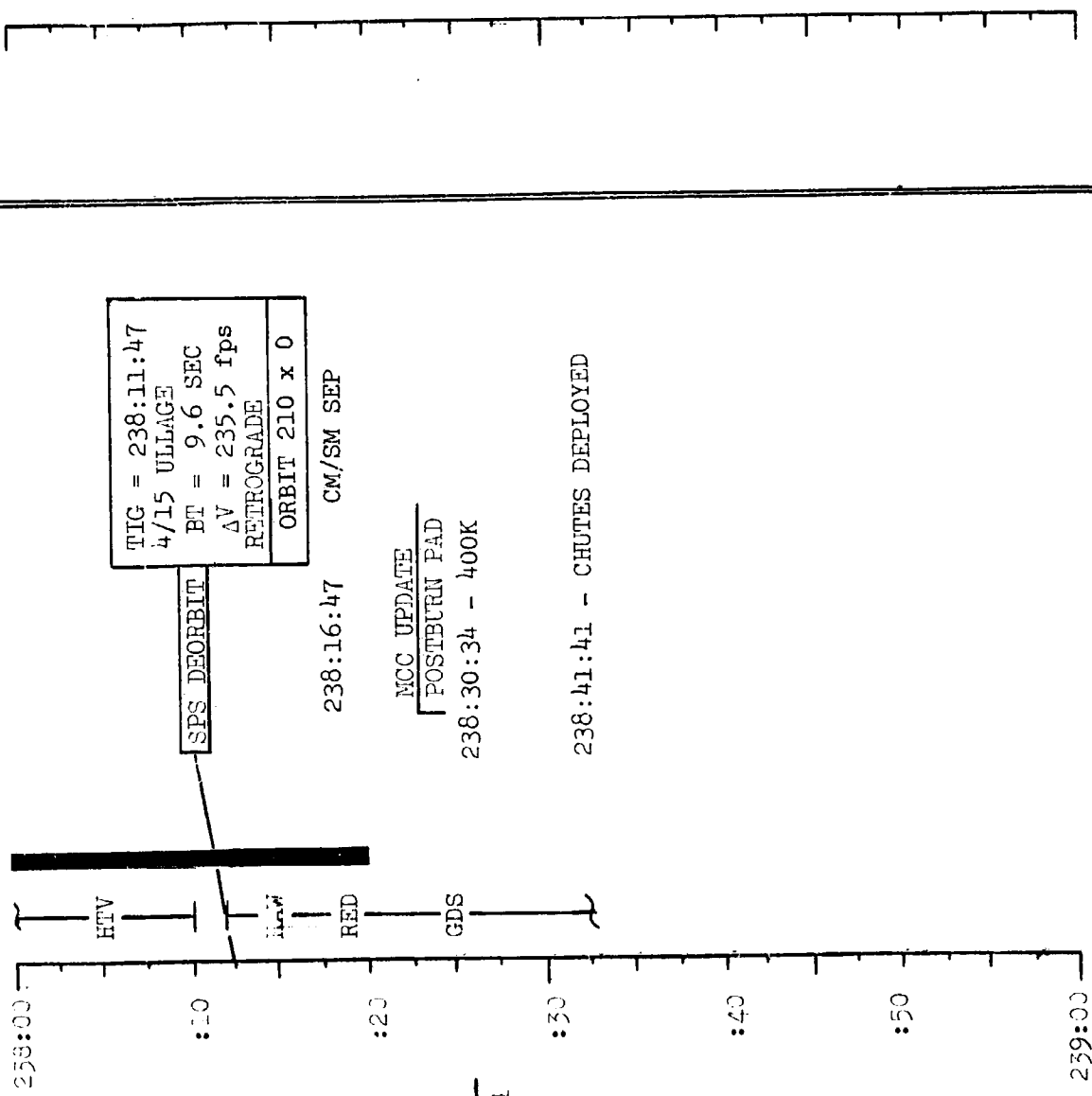

238:46:51 - SPLASHDOWN

MISSION	EDITION	DATE	TIME	DAY/REV	PAGE
APOLLO 9	FINAL	FEBRUARY 3, 1969	238:00 - 239:00	11/150-151	3-139

SECTION 4 - DETAILED TEST OBJECTIVE ACTIVITIES

SECTION 4

## SECTION 4

### DETAILED TEST OBJECTIVE ACTIVITIES

This section contains the activity summary sheets into which all the Detailed Test Objectives for Mission D have been incorporated. Revision 1, Change A of the Mission Requirements Document, D-Type Mission, IM Evaluation and Combined Operations is included. The activity summary sheets are presented in the same sequence as they will occur in the normal mission. Those mission activities which are repeated in the time-line are presented the first time they will occur only. DTO tasks and data requirements which are presently not scheduled in the flight plan are identified as "not implemented."

Each activity summary sheet contains the following data:

- A. DTO Reference - identifies the detailed test objective(s) (all or part) that are included in the given activity.
- B. Test Details - presents the special steps (other than standard procedures) which are required for performing the DTO. Constraints for performing the Activity are listed.
- C. Procedural Reference - identifies existing documents which contain procedures for performing the DTO.
- D. Data Requirements - lists the real time telemetry, developmental flight instrumentation and photography required to evaluate the DTO(s).
- E. Crew Logging/Recording Requirements - identifies the test information to be supplied by the crewman either written or voice recorded/transmitted. This information is used to evaluate the DTO's.

A cross reference is shown on pages 4-2 through 4-12 and lists the DTO's in numerical order and by title. This index relates the following additional information.

- o A subcategory breakdown of each DTO as was used in developing the Flight Plan.
- o Association of the subcategory DTO to the activity that implements it.
- o Identification of the activity summary sheet page number where the activity test data can be found.

The following ground rules will be used in implementing data requirements:

1. The collection of highly desirable (HD) data will not be allowed to constrain the timeline or crew procedures. It will be collected when doing so does not significantly constrain the timeline or crew procedures.
2. CSM data storage equipment (DSE) EBR recording will be done only when MSFN coverage is not available and when mandatory data is required.
3. Data collected by the crew that is required only for postflight analysis, will not be voiced to MSFN in real time.



CSM 104/LM3  
MISSION FLIGHT PLAN DTO  
CROSS REFERENCE TABLE

DTO NO.	DTO TITLE AND SUBCATEGORY	MISSION ACTIVITY TITLE	SECTION P NO.	REMARKS
P1.23	CSM Autopilot Stability Margin o CSM Burn of 4 to 7 Second Duration o CSM Burn of 40 or More Second Duration o CSM Burn of 50 or More Second Duration	SPS Burn No. 1 SPS Burn No. 2 SPS Burn No. 3	4-19 4-21 4-22	
P1.24	CSM IMU Alignment Accuracy o CSM IMU Alignments o Tracking Data for IMU Alignments o Tracking Data for IMU Alignments o CSM IMU Docked Alignment Check	Docked IMU Alignment SPS Burn No. 2 SPS Burn No. 3 Alignment Checks	4-17 4-21 4-22 4-18	
P1.25	IMU Orientation/Determination/Visibility	CSM Daylight Star Check	4-20	
S1.26	Orbital Navigation/Landmark Tracking	Orbital Navigation/Landmark Tracking	4-82	
P2.9	GNCS/MTVC Takeover	SPS Burn No. 3	4-22	
S7.29	Exhaust Effects/CSM o LES Exhaust Impingement o RCS Exhaust Impingement o Retrieve CSM Samples and Photograph CSM Radiators o Post Rendezvous Exhaust Impingement Photography	Launch Monitoring LM/CSM Ejection from SLA EVA Post Rendezvous Inspection	4-13 4-15 4-47 4-71	

CSM 104/LM3  
MISSION FLIGHT PLAN DTO  
CROSS REFERENCE TABLE

DTO NO.	DTO TITLE AND SUBCATEGORY	MISSION ACTIVITY TITLE	SECTION P NO	REMARKS
P11.5	<p>LM IMU Inflight Alignment</p> <ul style="list-style-type: none"> <li>o Data Collection for Determination of LM IMU Inflight Align Accuracy</li> <li>o Data Collection for Determination of LM IMU Inflight Align Accuracy</li> <li>o Data Collection for Determination of LM IMU Inflight Align Accuracy</li> <li>o LM AOT Alignments</li> <li>o LM Inflight IMU Align Accuracy</li> <li>o LM AOT Star Visibility Test</li> <li>o LM AOT Star Occultation</li> <li>o LM AOT Nighttime Star Observation - RR</li> <li>o LM AOT Nighttime Star Observation - S-Band Steerable</li> <li>o Obtain COAS Accuracy Data</li> </ul>	<p>Docked DPS Burn</p> <p>Rendezvous Phasing Burn</p> <p>Rendezvous Insertion Burn</p> <p>IMU Alignments</p> <p>APS CDH Burn</p> <p>Daytime AOT Star Visibility Test</p> <p>Daytime AOT Star Occultation</p> <p>LM AOT Nighttime Star Observation-RR</p> <p>LM AOT Nighttime Star Observation-S-Band Steerable</p> <p>LM COAS Calibration Check</p>	<p>4-42</p> <p>4-60</p> <p>4-64</p> <p>4-56</p> <p>4-68</p> <p>4-28</p> <p>4-29</p> <p>4-63</p> <p>4-62</p> <p>4-57</p>	
M11.6	<p>LM PGNC/DAP Performance &amp; Thrust Performance</p> <ul style="list-style-type: none"> <li>o DPS Burn Including Manual Throttling</li> <li>o PGNC Controlled Undocked DPS Burn with 10% throttle</li> <li>o PGNC Aligned Prior to First Undocked DPS Burn</li> </ul>	<p>Docked DPS Burn</p> <p>Rendezvous Insertion Burn</p> <p>Rendezvous Phasing Burn</p>	<p>4-42</p> <p>4-64</p> <p>4-60</p>	

CSM 104/LM3  
MISSION FLIGHT PLAN DTO  
CROSS REFERENCE TABLE

DTO NO.	DTO TITLE AND SUBCATEGORY	MISSION ACTIVITY TITLE	SECTION p NO.	REMARKS
P11.7	PGNCS Attitude/Translation Control o PGNCS Attitude Control o LM Manual Translation	LM PGNCS Attitude Control LM PGNCS Manual Translation	4-73 4-69	
P11.10	PGNCS and GNCS IMU Performance o GNCS IMU Performance o Data for LM IMU Performance o Data for IMU Performance o Data for IMU Performance o Data for IMU Performance o Data for IMU Performance o Data for CSM and LM IMU Performance o PGNCS IMU Performance o Data for LM IMU Performance o Data for LM IMU Performance o Data for LM IMU Performance	CSM PIPA Bias Test APS CDH Burn Launch Monitoring SPS Burn No. 1 SPS Burn No. 2 SPS Burn No. 3 Docked DPS Burn LM PIPA Bias Test Rendezvous Phasing Burn Rendezvous Insertion Burn APS Burn to Depletion	4-16 4-68 4-13 4-19 4-21 4-22 4-42 4-38 4-60 4-64 4-77	
P11.14	PGNCS Controlled APS Burn	APS Burn to Depletion	4-77	
P12.2	AGS Inflight Calibration & Performance o AGS Initialization o Data for AGS Calibration and Performance o AGS Gyro & Accelerometer Calibration o Data for AGS Calibration	AGS Initialization Docked DPS Burn AGS Calibration Rendezvous Phasing Burn	4-40 4-42 4-41 4-60	

CSM 104/LM3  
MISSION FLIGHT PLAN DTO  
CROSS REFERENCE TABLE

DTO NO.	DTO TITLE AND SUBCATEGORY	MISSION ACTIVITY TITLE	SECTION P. NO.	REMARKS
P12.3	AGS/CES Attitude/Translation Control o AGS/CES Manual Translation o AGS/CES Attitude Control	LM AGS Manual Translation LM AGS Attitude Control	4-59 4-55	
P12.4	AGS AV Capability Using DPS	Rendezvous Phasing Burn	4-60	
S13.10	APS Burn to Depletion	APS Burn to Depletion	4-77	
M13.11	Long Duration APS Burn	APS Burn to Depletion	4-77	
M13.12	DPS Burn Duration Effects and Primary Propulsion/Vehicle Interactions o DPS Burn of 200 seconds @ FTP o Undocked DPS Burn at 10% Throttle o Supercritical Helium Measurements	Docked DPS Burn Rendezvous Insertion Burn Crew Monitoring	4-42 4-64 4-83	
M14	LM ECS Performance o LM ECS Activation o Sublimator Dryout o Primary & Secondary Cartridge Removal o LM Depressurization, Repressurization, and PLSS Recharge o ECS Event Times & Data Collection	ECS Activation Sublimator Dryout LiOH Cartridge Removal EVA Crew Monitoring	4-26 4-46 4-50 4-47 4-83	

CSM 104/LM3  
MISSION FLIGHT PLAN DTO  
CROSS REFERENCE TABLE

DIO NO.	DIO TITLE AND SUBCATEGORY	MISSION ACTIVITY TITLE	SECTION P. NO.	REMARKS
M15.3	LM EPS Performance Determination o EPS Activation & Checkout o EPS Preparation for DPS Burn o Prestaging Check	EPS Activation & Checkout EPS Preparation for DPS Burn EPS Prestaging Check	4-25 4-58 4-67	
M16.4	Rendezvous Radar Tracking Performance o Rendezvous Radar Self Test o Rendezvous Radar Tracking Test o Rendezvous Radar Tracking Performance during Burn	Rendezvous Radar Self Test Rendezvous Radar Tracking Test Rendezvous Phasing Burn	4-51 4-65 4-60	
P16.6	Landing Radar Self Test	Landing Radar Self Test	4-39	
M16.7	Landing Radar/Structure/Plume o Operate Landing Radar in Position 1 During a DPS Burn o Prerequisite to LR Spurious Test o Operate LR in Position 2	Docked DPS Burn Landing Radar Self Test Rendezvous Phasing Burn	4-42 4-39 4-60	
P16.19	Rendezvous Radar/RCS Plume Impingement/Corona Effects	RR Corona Test No. 1	4-72	

CSM 104/LM3  
MISSION FLIGHT PLAN DIO  
CROSS REFERENCE TABLE

DIO NO.	DIO TITLE AND SUBCATEGORY	MISSION ACTIVITY TITLE	SECTION P NO.	REMARKS
M17.9	<ul style="list-style-type: none"> <li>Landing Gear Deployment/Thermal</li> <li>o Landing Gear Deployment</li> <li>o Landing Gear Temperature Data and Observed Exhaust Impingement</li> <li>o Landing Gear Temperature Data On T/M.</li> <li>o Landing Gear Temperature Data On T/M</li> <li>o Landing Gear Photography</li> </ul>	<ul style="list-style-type: none"> <li>Landing Gear Deployment</li> <li>Docked DPS Burn</li> <li>Rendezvous Insertion Burn</li> <li>Rendezvous Phasing Burn</li> <li>LM/CSM Undocking &amp; Inspection</li> </ul>	<ul style="list-style-type: none"> <li>4-33</li> <li>4-42</li> <li>4-64</li> <li>4-60</li> <li>4-52</li> </ul>	
M17.17	<ul style="list-style-type: none"> <li>LM Environmental and Propulsion Thermal Effects</li> <li>o Long Duration APS Burn</li> <li>o Three Seconds of LM RCS Ullage Burn and a Long DPS Burn at FIP</li> <li>o Retrieve Samples from the Exterior of the LM and Take Photographs</li> <li>o Post Rendezvous Exhaust Inspection</li> </ul>	<ul style="list-style-type: none"> <li>APS Burn to Depletion</li> <li>Docked DPS Burn</li> <li>EVA</li> <li>Post Rendezvous Inspection</li> </ul>	<ul style="list-style-type: none"> <li>4-77</li> <li>4-42</li> <li>4-47</li> <li>4-71</li> </ul>	
M17.18	<ul style="list-style-type: none"> <li>LM Structural Integrity</li> <li>o LM Structural Integrity During Saturn V Launch</li> <li>o LM Structural Integrity During APS Burn</li> <li>o LM Structural Integrity During DPS Burn</li> <li>o LM Dynamic Response During DPS Burn</li> </ul>	<ul style="list-style-type: none"> <li>Launch Monitoring</li> <li>APS Burn to Depletion</li> <li>Docked DPS Burn</li> <li>Rendezvous Phasing Burn</li> </ul>	<ul style="list-style-type: none"> <li>4-13</li> <li>4-77</li> <li>4-42</li> <li>4-60</li> </ul>	

CSM 104/LM3  
MISSION FLIGHT PLAN DTO  
CROSS REFERENCE TABLE

DTO NO.	DTO TITLE AND SUBCATEGORY	MISSION ACTIVITY TITLE	SECTION P. NO.	REMARKS
MI7.18 (Cont)	<ul style="list-style-type: none"> <li>o LM Dynamic Response During DPS Burn</li> <li>o DFI and Tracking Data for APS Burn</li> <li>o T &amp; D Photography</li> <li>o Undocking Photography</li> <li>o Post Rendezvous Photography</li> </ul>	<p>Rendezvous Insertion Burn</p> <p>APS CDH Burn</p> <p>CSM Transposition and Docking</p> <p>LM/CSM Undocking and Inspection</p> <p>Post Rendezvous Inspection</p>	<p>4-64</p> <p>4-68</p> <p>4-14</p> <p>4-52</p> <p>4-71</p>	
P20.21	<p>LM/MSFN S-Band Communication Performance</p> <ul style="list-style-type: none"> <li>o Signal Combination Mode 2</li> <li>o Signal Combination Mode 4</li> <li>o Signal Combination Mode 6</li> <li>o Signal Combination Mode 7</li> <li>o Signal Combination Mode 8</li> <li>o Signal Combination Mode 10</li> <li>o LM Steerable Antenna Test</li> </ul>	<p>Communications Tests-LM Acti- vation</p> <p>Communications Tests-LM Acti- vation</p> <p>Communications Tests-LM Acti- vation</p> <p>PLSS Communication Checks</p> <p>PLSS Communication Checks</p> <p>PLSS Communication Checks</p> <p>LM Steerable Antenna Test</p>	<p>4-31</p> <p>4-31</p> <p>4-31</p> <p>4-36</p> <p>4-36</p> <p>4-36</p> <p>4-30</p>	
P20.22	<p>LM/CSM/MSFN S-Band/VHF Compatibility</p> <ul style="list-style-type: none"> <li>o Voice: EMU <math>\xrightarrow{\text{VHF}}</math> LM</li> <li>o Voice: EMU <math>\xrightarrow{\text{VHF}}</math> CSM</li> </ul>	<p>EVA Communications Test</p> <p>EVA Communications Test</p>	<p>4-49</p> <p>4-49</p>	

CSM 104/LM3  
MISSION FLIGHT PLAN DTO  
CROSS REFERENCE TABLE

DTO NO.	DTO TITLE AND SUBCATEGORY	MISSION ACTIVITY TITLE	SECTION P NO.	REMARKS
P20.22 (Cont)	<ul style="list-style-type: none"> <li>o Voice &amp; EMU Biomed: VHF Relay S-Bd EMU → LM → MSFN &amp; Return</li> <li>o Voice &amp; EMU Biomed: VHF Relay S-Bd EVA → CSM → MSFN</li> <li>o Voice &amp; T/M: CSM → S-Bd → MSFN &amp; Voice Return</li> <li>o Voice &amp; T/M: LM → S-Bd → MSFN &amp; Voice Return</li> <li>o LBR Data S-Bd VHF DUMP S-Bd LM → CSM → MSFN &amp; LM → MSFN</li> <li>o Voice: S-Bd Relay S-Bd LM → MSFN → CSM &amp; Return</li> <li>c Voice: VHF Relay S-Bd LM → CSM → MSFN &amp; Return</li> <li>o Voice: VHF Relay S-Bd CSM → LM → MSFN &amp; Return</li> </ul>	<p>PLSS Communication Checks</p> <p>EVA Communication Test</p> <p>Rendezvous Communications Tests</p> <p>Rendezvous Communications Tests</p> <p>Communications Tests - LM Activation</p> <p>Relay Tests</p> <p>Relay Test</p> <p>Relay Test</p>	<p>4-35</p> <p>4-49</p> <p>4-66</p> <p>4-66</p> <p>4-31</p> <p>4-34</p> <p>4-34</p> <p>4-34</p>	



CSM 104/LM3  
MISSION FLIGHT PLAN DTO  
CROSS REFERENCE TABLE

DTO NO.	DTO TITLE AND SUBCATEGORY	MISSION ACTIVITY TITLE	SECTION P. NO.	REMARKS
P20.22 (Cont)	o S-Band LBR for CSM DSE Recording and Playback	Communication Test - LM Activation	4-31	
M20.24	CSM Active Docking	CSM Transposition & Docking	4-14	
P20.25	LM Ejection from SLA o LM Ejection from SLA o Still Photography of LM Exterior o Still Photography of LM Exterior	LM/CSM Ejection from SLA LM/CSM Undocking & Inspection EVA	4-15 4-52 4-47	
P20.26	LM-CSM Undocking	LM/CSM Undocking & Inspection	4-52	
P20.27	LM Evaluation Rendezvous	Rendezvous Data	4-70	
P20.28	LM Active Docking	LM Active Docking	4-75	
P20.29	LM Jettison	LM Jettison	4-76	
P20.31	Support Facilities Performance	Crew Monitoring	4-83	

CSM 104/LM3  
MISSION FLIGHT PLAN DTO  
CROSS REFERENCE TABLE

DTO NO.	DTO TITLE AND SUBCATEGORY	MISSION ACTIVITY TITLE	SECTION P. NO.	REMARKS
S20.32	<ul style="list-style-type: none"> <li>o Crew Activities Evaluation CSM/LM</li> <li>o Crew Activities &amp; Evaluation (CSM-LM)</li> <li>o LM and CM Acoustical Environment During DPS Burn</li> <li>o LM Acoustics During DPS Burn</li> <li>o LM Acoustics During DPS Burn</li> <li>o Pressurized PGA in a Depressurized Cabin</li> <li>o Subjective Comments on CM Acoustical Environment During Launch</li> <li>o Tunnel Clearing</li> <li>o Comments &amp; Photography on Unfolding Couch</li> <li>o Comments &amp; Photography on Folding CM Couch</li> <li>o Tunnel Clearing</li> <li>o Comments, Photography on Positioning within CM Couch Prior to Docking</li> <li>o LM Crew Rendezvous Evaluation</li> <li>o Acoustical Environment During APS Burn</li> </ul>	<ul style="list-style-type: none"> <li>Crew Monitoring</li> <li>Docked DPS Burn</li> <li>Rendezvous Insertion Burn</li> <li>Rendezvous Phasing Burn</li> <li>EVA</li> <li>Launch Monitoring</li> <li>Tunnel Clearing - Three Crewmen in CM</li> <li>Crew Monitoring</li> <li>Crew Monitoring</li> <li>Tunnel Clearing - Two Crewmen in LM</li> <li>CSM Transposition &amp; Docking</li> <li>Rendezvous Data</li> <li>APS CDH Burn</li> </ul>	<ul style="list-style-type: none"> <li>4-84</li> <li>4-42</li> <li>4-64</li> <li>4-60</li> <li>4-47</li> <li>4-13</li> <li>4-24</li> <li>4-84</li> <li>4-84</li> <li>4-45</li> <li>4-14</li> <li>4-70</li> <li>4-68</li> </ul>	

CSM 104/LM3  
MISSION FLIGHT PLAN DTO  
CROSS REFERENCE TABLE

DTO NO.	DTO TITLE AND SUBCATEGORY	MISSION ACTIVITY TITLE	SECTION NO.	REMARKS
P20.33	CSM Single Crewman Rendezvous Capability	Rendezvous Data	4-70	
P20.34	Intravehicular Crew Transfer o Crew Transfer to LM o Installation of Tunnel Hardware o Crew Transfer to CM	Tunnel Clearing - Three Crewmen in CM Tunnel Hardware Installation Tunnel Clearing - Two Crewmen in LM	4-45 4-27 4-24	
M20.35	Extravehicular Activity	EVA	4-47	
S20.37	DPS Plume Effect o Observe and Photograph DPS Plume o Observe the DPS Plume	Docked DPS Burn Rendezvous Insertion Burn	4-42 4-64	
S20.121	CSM/LM Electromagnetic Compatibility	Crew Monitoring	4-83	
Experiment	S065 Photography	S065 Photography	4-78	

## LAUNCH MONITORING

### A. DTO Reference

1. S7.29 - LES Exhaust Impingement
2. P11.10 - Data for IMU Performance
3. M17.18 - LM Structural Integrity During Saturn V Launch
4. S20.32 - Subjective Comments on CM Acoustical Environment During Launch

### B. Test Details

There are no special test procedures.

### C. Procedural Reference

NONE

### D. Data Requirements

1. CSM HBR (M)
2. LM DFI (for five minutes) (M)  
[M17.18]
3. MSFN tracking (trajectory data) from liftoff through earth orbit insertion (M) [P11.10] (M17.18]
4. MSFN data as follows: (M) [M17.18]
  - a. S-V acceleration
  - b. S-1C thrust variations
  - c. Wind data
  - d. Dynamic pressure & angle of attack

### E. Crew Logging/Recording Requirements

1. Subjective comments on CM acoustical environment (M) [S20.32]
2. Narrative describing vehicle dynamic response during the S-1C operation (M) [M17.18]
3. Comments on the observable effects of LES engine exhaust impingement on CM windows (M) [S7.29]

CSM TRANSPOSITION AND DOCKING (GET 02: 47 : 00)

A. DTO Reference

1. M17.18 - T&D Photography
2. M20.24 - CSM Active Docking
3. S20.32 - Comments, Photography on Positioning Within CM Couch Prior to Docking

B. Test Details

1. Perform docking in sunlight with the LM/S-IVB. [M20.24]
2. Take pictures of SLA/LM, LM upper outrigger strut, and relative motion with 16mm sequence camera from CM right window (from transposition to probe/drogue latching). [M20.24] [M17.18]
3. Take pictures of crewman positioning in couch prior to docking. [S20.32] (NOT IMPLEMENTED)

C. Procedural Reference

CSM/SLA Separation Through Captive Latch, Section 4.5.1.1  
Docking with LM/S-IVB, Section 4.5.1.3  
AOH SM2A-03-SC104 - (2)

D. Data Requirements

1. CSM HBR data (M) [M20.24]
2. MSFN coverage for S-IVB data (M) [M20.24]  
Note - All data are required from just prior to contact thru final latching.
3. Couch photography (HD) [S20.32]
4. T&D Photography
  - o Relative Motion (M) [M20.24]
  - o Probe and Drogue area, and upper outrigger strut (HD) [M17.18]

E. Crew Logging/Recording Requirements

1. GET when active docking was initiated (after transposition and after docking attitude is achieved) (M) [M20.24]
2. CSM handling characteristics during docking (M) [M20.24]
3. Adequacy of visual docking cues on the LM (M) [M20.24]
4. GET when docking complete (including connection of electrical umbilicals and hatch closing) (M) [M20.24]
5. Condition of relative rotational alignment between LM & CSM during docking (M) [M20.24]
6. Comment on crew capability to obtain the required couch position for docking (M) [S20.32]

LM/CSM EJECTION FROM SLA (GET 04:07:00)

A. DTO Reference

1. S7.29 - RCS Exhaust Impingement
2. P20.25 - LM Ejection From SLA

B. Test Details

1. LM/CSM is ejected from the SLA. [P20.25]
2. 16 mm photography is taken from CSM right hand rendezvous window to record the ejection maneuver [P20.25]

C. Procedure Reference

LM Withdrawal from the SLA, Section 4.5.1.4,  
AOH SM2A-03-SC104 - (2)

D. Data Requirements

1. CSM HBR Data (M) [P20.25]
2. MSFN coverage for S-IVB data (M) [P20.25]
3. Photographic coverage from initiation of ejection through clearance from SLA (M) [P20.25]

E. Crew Logging/Recording Requirements

1. Dynamic characteristics of CSM/LM during ejection (M) [P20.25]
2. Stability characteristics and adequacy of attitude control of S-IVB/SLA prior to, during, and after ejection (M) [P20.25]
3. Adequacy of visibility from sunlight and CSM docking lights (HD) [P20.25]
4. Comments as to observable effects of exhaust from SM RCS engines (M) [S7.29]

CSM PIPA BIAS TEST

A. DTO Reference

P11.10 - GNCS IMU Performance

B. Test Details

1. CMC is powered up during test
2. Allow PIPA counts for 5 minutes during test (to telemetry)
3. Spacecraft in free drift
4. Astronaut motions minimal
5. The test is conducted at the following times:
  - a. Following LM extraction from S-IVB/SLA
  - b. Prior to first GNCS shutdown
  - c. Following as many GNCS power ups as possible
  - d. Prior to entry

C. Procedural Reference

Conducted by MSFN.

D. Data Requirements

1. CSM LBR data (M)
2. MSFN Coverage for S-IVB data (M)

E. Crew Logging/Recording Requirements

NONE

NOTE: PIPA BIAS Performed By MSFN Over Station

DOCKED IMU ALIGNMENT

A. DTO Reference

Pl.24 - CSM IMU Alignments

B. Test Details

Perform as many alignments as practical while docked. There are no special test procedures.

C. Procedural Reference

IMU Realign (P52), Section 4.11.2, AOH SM2A-03-SC104-(2)

D. Data Requirements

CSM LBR (required at time star markings are performed) (M)

E. Crew Logging/Recording Requirements

1. Attitude control mode (M)
2. Star identification:
  - 1st (M)
  - 2nd (M)
3. Star angle difference (M)
4. Gyro torquing angles (M)
5. Comments on adequacy of controls, displays, visibility, etc. (M)



## ALIGNMENT CHECKS

### A. DTO Reference

P1.24 -- CSM IMU Docked Alignment Checks

### B. Test Details

1. At least three alignment checks will be performed following each of two alignments. (Alignments may be either P51 or P 52 (GET 05 : 20 : 00 , 21 : 30 : 00 )
2. The checks shall consist of re-running the alignment program (P52) with deviation as follows:
  - a. Perform a Program 52 to star selection routine (DSKY flashes requesting star acquisition).
  - b. Bypass star selection routine and maneuver to select a new star. When DSKY flashes VO1N70, Key V21E and load desired star code. Record star code.
  - c. Monitor DSKY for inserted star code.
  - d. Select automatic optics positioning and continue program with step 12 in procedures.
  - e. In Step 13 of procedures, repeat (b) through (d) above for 2nd star, and select automatic optics positioning. Continue program with Step 17 in AOH P52 procedures.
  - f. Complete Step 18 by reading gyro torquing angles. Do not torque the IMU. Key V32E and re-enter P52.
  - g. Repeat steps (b) through (f) above for a second test.
  - h. Repeat steps (b) through (f) above for a third test.
3. This test may be accomplished in daylight or at night.
4. Two different star pairs are desired for each alignment check.

### C. Procedural Reference

IMU Realign (P52), Section 4.11.2  
AOH SM2A-03-SC104 - (2)

### D. Data Requirements

CSM LBR data (required during star markings) (M)

### E. Crew Logging/Recording Requirements

1. Attitude control mode (M)
2. Star identification:
  - 1st (M)
  - 2nd (M)
3. Star angle difference (M)
4. Gyro torquing angles (M)
5. Comments on adequacy of controls, displays, visibility, etc. (M)

SPS BURN NO.1 (GET 06:01:40)

A. DTO Reference

1. P1.23 - CSM Burn of 4 to 7 Seconds Duration
2. P11.10 - Data for IMU Performance

B. Test Details [P1.23]

1. Perform normal GNCS SPS burn procedures
2. Burn Parameters
  - Ullage: 0 sec
  - SPS Burn Duration: 5 sec
  - $\Delta V$ : 36.8 fps
  - Guidance: G&N - EXT  $\Delta V$

C. Procedure Reference

G&N/SPS Orbit Change Thrusting (P40), Section 4.14.2  
AOH SM2A-03-SC104 - (2)

D. Data Requirements

1. CSM HBR (M) [P1.23]
2. MSFN tracking data required prior to and after burn (M)  
(Tracking will occur as a normal mission function whenever a ground station is available.) [P1.23] [P11.10]

E. Crew Logging/Recording Requirements (HD) [P1.23]

Comments on vehicle vibrations.....

CSM DAYLIGHT STAR CHECK (GET 06: 30: 00)

A. DTO Reference

Pl.25 - IMU Orientation Determination/Visibility

B. Test Details

1. IMU (P52) Alignment Precedes Test
2. Maneuver to attitude supplied by MSFN:

The spacecraft will be oriented to an inertial attitude with the LM nearest the earth and the X-axis making an angle of  $30^\circ$  with the line of sight to the sun with the CSM tilted toward the sun. The spacecraft should then be rolled clockwise  $40^\circ$  (as viewed from inside the command module) away from the heads down attitude about the X-axis. This will give a  $40^\circ$  angle between the optics line of sight and the plane determined by the spacecraft X-axis and the line of sight to the sun. The optics shaft angle should be  $180^\circ$  and the trunnion angle should be  $12^\circ$  (i.e., away from the LM). This position will provide maximum shading of the LM S-band antenna and thus minimize reflected light from the antenna.

3. Power up optics
4. Observations begin (no recordings) 15 minutes prior to sunrise using SCT.
5. Identify dimmest star in the SCT at spacecraft sunrise - Record
6. Identify dimmest star in the SCT 5 min after sunrise - Record
7. Identify dimmest star in the SCT 10 min after sunrise - Record

C. Procedural Reference

Optics Power Control, Section 4.10.1.4  
AOH SM2A-03-SC104 - (2)

D. MSFN Data Requirements

1. CSM LBR data (M)
2. MSFN best estimate of trajectory during star observations (M)

E. Crew Logging/Recording Requirements

1. Sunrise:
  - a. Identify dimmest star (M)
  - b. Visibility, earth cloud cover (HD)
  - c. Comments on reflected light from LM and vented particles (HD)
2. Sunrise plus 5 minutes:
  - a. Identify dimmest star (M)
  - b. Visibility, earth cloud cover (HD)
  - c. Comments on reflected light from LM and vented particles (HD)
3. Sunrise plus 10 minutes:
  - a. Identify dimmest star (M)
  - b. Visibility, earth cloud cover (HD)
  - c. Comments on reflected light from LM and vented particles (HD)

'SPS BURN NO. 2 (GET 22:12:00)

A.- DTO Reference

1. P1.23 - CSM Burn of 40 or More Seconds Duration
2. P1.24 - Tracking Data for IMU Alignments
3. P11.10 - Data for IMU Performance

B. Test Details

1. Check ESTROKER, Key V06N02E, then key 03012E. (R100002) indicates 40% stroking for Colossus 237).
2. Initiate P40 Thrusting Program.
3. Source for angles displayed on FDAI to be CMC. [P1.23]
4. Select FDAI rate scale of 5/1 [P1.23]
5. FDAI select 1/2
6. Perform normal GNCS SPS burn procedures.
7. At 60 seconds after ignition Key V68E (initiates stroker program). Stroker test begins immediately after V68E. Test automatically terminates after 7.3 seconds or sooner if restart occurs.
8. If maximum value of FDAI rate indicator exceeds 0.8 degrees/second (peak to peak), then full amplitude test will not be performed on Burn No. 3. [P1.23]
9. Burn Parameters:  
Ullage: 0 sec  
SPS Burn Duration: 111.1 sec  
 $\Delta V$ : 850.1 fps  
Guidance: G&N - Ext  $\Delta V$

C. —Procedural Reference

G&N/SPS Orbit Change Thrusting (P40), Section 4.14.2, AOH,  
SM2A-03-SC104-(2)

D. Data Requirements

1. CSM HBR (M) [P1.23]
2. MSFN best estimate of trajectory required a minimum of 60 seconds prior to and 60 seconds after burn (HD) [P1.24];(M) [P11.10]

E. Crew Logging/Recording Requirements

Comments on vehicle vibrations (HD) [P1.23]

SPS BURN NO. 3 (GET 25:18:30)

A. DTO Reference

1. P1.23 - CSM Burn of 50 or More Seconds Duration
2. P1.24 - Tracking Data for IMU Alignments
3. P2.9 - GNCS/MTVC Takeover
4. P11.10 - Data for IMU Performance

B. Test Details

1. Perform normal G&N Prethrusting (P30) [P2.9]
2. If maximum value of FDAI rate indicator exceeds 0.8 degree/second (peak to peak) on Burn No. 2, then full amplitude test will not be performed. [P1.23]
3. Prior to starting the P40 SPS Thrusting Program the ESTROKER load parameter for amplitude is changed as follows: [P1.23]
  - .Key V21N01E
  - .Key 03012E (address)
  - .Key 00005E (for full amplitude on Colossus 237)
4. To check existing load, key V06 N02 E, then key address.
5. Source for angles displayed on FDAI to be CMC [P1.23]
6. Select FDAI rate scale of 5/1. [P1.23]
7. Verify Pitch and Yaw SCS TVC is in Rate Command [P2.9]
8. Perform normal G&N SPS burn procedures. [P1.23]
9. At 60 sec after SPS ignition, key V68E (initiates stroker program - full amplitude).
10. Test automatically terminates after 7.3 seconds or sooner if restart occurs
11. Observe from FDAI and GPI that steady state burn conditions have been achieved prior to MTVC [P2.9]
12. At  $\approx 234$  sec after SPS ignition (shutdown minus 45 sec) initiate MTCV takeover (TC clockwise)
13. Engine shutdown will be by EMS  $\Delta V$  counter [P2.9]
14. Burn Parameters
  - Ullage: 0
  - SPS Burn Duration: 279.4 sec
  - $\Delta V$  2549.1 fps
  - Guidance: G&N - Ext  $\Delta V$

C. Procedure Reference

G&N SPS Orbit Change Thrusting (P40), Section 4.14.2  
AOH SM2A-03-SC104 - (2)

D. Data Requirements

1. CSM HBR (M). [P1.23]
2. MSFN best estimate of trajectory required for a minimum of 60 seconds prior to and 60 seconds after burn (HD) [P1.24]; (M) for [P11.10]

E. Crew Logging/Recording Requirements

1. Comments on vehicle vibrations (HD) [P1.23]
2. Comments on handling characteristics during MTVC (M) [P2.6]
3. Visual cues used by crewman for altitude control during MTVC (M) [P2.6]

TUNNEL CLEARING - THREE CREWMEN IN CM (GET 41 : 55 : 00 )

A. DTO Reference

1. S20.32 - Tunnel Clearing
2. P20.34 - Crew Transfer to LM

B. Test Details

1. Crew fully suited with PGAs unpressurized [P20.34]
2. Tunnel will be pressurized. [P20.34]
3. CM/LM hard docked [P20.34]
4. Three crewmen initially in CM [P20.34]
5. Photography of tunnel clearing activity will be made [S20.32]

C. Procedural Reference

1. Docking Probe Removal (CM Side) Section 4.5.4.1  
Docking Drogue Removal (CM Side) Section 4.5.4.4  
AOH SM2A-03-SC104 - (2)
2. Intravehicular Transfer, Sections 4.14.1 through 4.14.4  
AOH LMA 790-3-LM3

D. Data Requirements

Photography of tunnel clearing and hardware stowage from  
CM (HD) [S20.32]

E. Crew Logging/Recording Requirements

1. Time required for three crewmen to remove and stow tunnel components (Timing starts with the removal of the CSM forward pressure hatch.) (M) [P20.34]
2. Time required for the LMP to IVT to the LM from ingress to the CM tunnel to starting the entry status check (M) [P20.34]
3. Comments on tunnel clearing (M) [P20.34] [S20.32]
4. Comments on design of tunnel components (M) [P20.32]
5. Comments on a crewman IVT to LM (M) [P20.34]
6. Comments on attaching crew restraint system in the LM (M) [S20.32]

EPS ACTIVATION AND CHECKOUT (GET 42 : 35 : 00)

A. DTO Reference

M15.3 - EPS Activation and Checkout

B. Test Details

Crewman activation of the LM EPS will include the following:

1. Transfer LM electrical loads from CSM to LM.
2. Switch descent batteries from low taps to high taps.
3. Operate backup inverter.

C. Procedural Reference

EPS Activation and Checkout, Section 4.2.2, AOH LMA 790-3-LM3

D. Data Requirements

1. LM HBR (as permitted by MSFN acquisition) (M)
2. Battery temperature data (via DFI) will be collected over stations requiring DFI for other functions.

E. Crew Logging/Recording Requirements

None



ECS ACTIVATION (GET 42 : 50 : 00 )

A. DTO Reference

M14 - LM ECS Activation

B. Test Details

No special test details

C. Procedural Reference

ECS Activation and Checkout, Section 4.2.12, AOH LMA 790-3-LM3

D. Data Requirements

1. LM HBR (HD)

2. LM LBR (M)

3. LM DFI (M)

Note: All telemetry data is required for 5 minutes including the end of ECS activation.

E. Crew Logging/Recording Requirements

None

TUNNEL HARDWARE INSTALLATION (GET 43:15:00)

A. DTO Reference

P20.34 - Installation of Tunnel Hardware

B. Test Details

1. Crew fully suited with PGAs unpressurized [P20.34]
2. Tunnel will be pressurized. [P20.34]
3. CM/LM hard docked [P20.34]
4. Two crewmen in LM and one crewman in CM [P20.34]

C. Procedural Reference

1. Close Overhead Hatch (LM Side), Section 4.14.9,  
Install Drogue (LM Side), Section 4.14.11,  
AOH LMA 790-3-LM3
2. Docking Probe Installation (CM Side), Section 4.5.4.3,  
AOH SM2A-03-SC104-(2)

D. Data Requirements

---

None

E. Crew Logging/Recording Requirements

Time required to re-install tunnel components working from both the CM and the LM. (Timing starts with the acquisition of the first piece of hardware for installation.) (M) [P20.34]

DAYTIME AOT STAR VISIBILITY TEST (GET 43 : 55 : 00)

A. DTO Reference

P11.5 - LM AOT Star Visibility Test

B. Test Details

1. Perform at a normal mission timeline attitude.
2. LM is undocked. (not implemented)
3. Window shades are installed.
4. Approximately 10 minutes of dark adaptation will precede test.
5. Place a nav star in the center of the field of view of the AOT
6. Identify dimmest star in the visible pattern around the nav star.

C. Procedural Reference

None

D. Data Requirements

MSFN best estimate of trajectory (M)

E. Crew Logging /Recording Requirements

1. AOT detent position (M)
2. GET at which dimmest star is observed (M)
3. IMU gimbal angles as read from the DSKY each time dimmest star is identified in a visibility test (M)
4. Identify dimmest star during count (M)

DAYTIME AOT STAR OCCULTATION  
(not implemented)

A. DTO Reference

P11.5 - LM AOT Star Occultation

B. Test Details

1. Performed when sun is approaching AOT line of sight.
2. Identifiable stars are visible in the AOT.
3. Observe star field in AOT and record GET and gimbal angles when star washout occurs.

C. Procedural Reference

None

D. Data Requirements

MSFN Best estimate of trajectory (M)

E. Crew Logging/Recording Requirements

1. GET of star washout (M)
2. Gimbal angles at star washout (M)
3. AOT detent position (M)

LM STEERABLE ANTENNA TEST ( GET 44:03:00 )

A. DTO reference

P20 21 - LM Steerable Antenna Test

B. Test Details

1. Perform S-Band Steerable Antenna Check AOH procedure through step 6. Record GET of initial lock-on.
2. Manually adjust antenna for maximum signal strength. Record GET, signal strength, and antenna pitch and yaw angles.
3. Deliberately slew antenna in pitch and yaw such that a noticeable decrease in signal strength is detected. Record GET and signal strength. (Not implemented)
4. Continue with procedure step 7. Record GET of switch to Auto, record antenna pitch and yaw, and signal strength. (Not implemented)
5. Monitor for 1 minute and record pitch and yaw and signal strength.
6. LM tracking of MSFN station will use signal combination Mode 2.

C. Procedural Requirements

S-Band Steerable Antenna Check, Section 4.13.2.8  
AOH LMA790-3-LM3

D. Data Requirements

1. LM HBR (M)
2. MSFN S-Band tracking data processor output (M)
3. MSFN recording of LM to MSFN voice (M)
4. MSFN records of acquisition times (HD)
5. MSFN recording of telemetry bit stream (M)
6. MSFN to use uplink modes 4, 5 and 6 during test (M)

E. Crew Logging/Recording Requirements

1. Comments on quality of MSFN voice (if not recorded on LM tape recorder) (M)
2. Crewman logs/records data as indicated under steps 1, 2, 3, 4 and 5 of Test Details (M)

Note: This test is secondary and is to be performed on a non-interference basis only.

## COMMUNICATIONS TESTS - LM ACTIVATION

### A. DTO Reference

P20.21 - Signal Combination Modes 2, 4, 6

P20.22 - S-Band LBR for CSM DSE Recording and Playback

### B. Test Conditions

These tests will be demonstrated by normal communications procedures during LM manned activity periods with the constraint that each be performed at least once. Tests are listed in the order of desired priority as follows:

1. Signal Combination Mode 2 (LM Communications Basic) [P20.21]  
(GET 44 : 51 : 00)
    - a. This mode will consist of primary and secondary S-band with PRN ranging, Voice, H.L. biomed, high-bit-rate PCM modulation, and primary S-band power amplifier.
    - b. Five minutes of total data and two minutes of continuous data are required with the primary S-band transceiver.
    - c. Two minutes of total data and one minute of continuous data are required with the secondary S-band receiver.
  2. LM LBR Transmission [P20.22] GET - See Note
    - a. Test will be performed during rendezvous with a passive CSM. (not implemented)
    - b. LM will transmit LBR PCM telemetry to the CSM for DSE recording and subsequent playback to MSFN via S-band.
- Note: This mode is implemented by normal LM/CSM communications during periods of MSFN LOS (recording) and AOS (playback) throughout the LM Systems Activation and EVA days.
3. Signal Combination Mode 4 (S-Band Backup Voice) [P20.21] (GET 44:12:00)
    - a. This mode will consist of primary and secondary S-band with backup voice, LBR PCM telemetry, and low S-band amplifier power.
    - b. Five minutes of total data and two minutes of continuous data are required with the primary S-band transceiver. (not implemented)
    - c. Two minutes of total data and one minute of continuous data are required with the secondary S-band transceiver. (not implemented)
  4. Signal Combination Mode 6 (S-Band Key Check) [P20.21]  
(GET 44 : 12 : 00)
    - a. This mode will consist of S-band carrier with keying modulation and low S-band amplifier power.
    - b. Two minutes of total data are required. (not implemented)

Note: This check must be performed over MIL or MSFN stations with 85' S-Band dish antennas.

C. Procedural Reference

"Subsystem Activation," Section 4.2 (4.2.14, 26, 27)  
AOH LMA 790-3-LM3

D. Data Requirements

1. PCM HBR (M) [Test B.1.-P20.21]
2. MSFN recording of LM to MSFN Voice (M) [Test B.1.-P20.21]
3. PCM LBR (M) [Test B.2.-P20.21]
4. LM to CSM Voice and MSFN recording of CSM DSE playback (M)  
[Test B.2.-P20.22]
5. MSFN recording of keying communication (M) [Test B.4.-P20.21]
6. MSFN records of acquisition times (M) [P20.21]
7. Unified S-Band tracking data processor output (M) [P20.21]

E. Crew Logging/Recording Requirements

Astronaut comments on quality of MSFN Voice (M) [P20.21]

LANDING GEAR DEPLOYMENT (GET 45:00 : 00)

A. DTO Reference

M17.9 - Landing Gear Deployment

B. Test Details

Landing gear deployed during daylight prior to the first DPS burn.

C. Procedural Reference

Landing Gear Deploy, Section 4.2.36, AOH LMA 790-3-LM3

D. Data Requirements

1. LM HBR (M)
2. LM DFI (HD)

E. Crew Logging/Recording Requirements

1. Landing gear deployment initiation time (GET +1.0 sec) (M)
2. Comments on landing gear deployment and downlock shock (M)



## RELAY TESTS

### A. DTO Reference

P20.22 - Communications Using LM, CSM and MSFN Relay Functions\*

### B. Test Details

1. Tests will be performed during rendezvous (not implemented).
2. CSM and LM communications configuration at the beginning of the tests are described on page 5-2 of the Communications Plan.
3. CSM Relay Details: (GET 45:40:00)

LM  $\xrightarrow{\text{VHF}}$  CSM  $\xrightarrow{\text{Relay S-Bd}}$  MSFN

- a. CMPs backup audio control is selected.
  - b. The CMP will be on the CDR's umbilical.
  - c. CMPs S-Band volume control is increased.
  - d. CMPs relay is enabled.
  - e. LM S-Band voice is disabled.
  - f. MSFN transmits/receives voice via S-Band only.
  - g. Voice communications between LM and MSFN  $\approx$  one minute.
  - h. CMPs S-Band volume control is fully decreased (CSM).
  - i. LM S-Band voice is enabled.
4. LM Relay Details (GET 46:23:00)

CSM  $\xrightarrow{\text{VHF}}$  LM  $\xrightarrow{\text{Relay S-Bd}}$  MSFN & return

- a. LMP relay is enabled (LM).
  - b. CDR S-Band volume is increased (LM).
  - c. S-Band voice is disabled (CSM).
  - d. MSFN transmits/receives voice via S-Band only
  - e. Voice communications between LM and MSFN  $\approx$  one minute.
  - f. CSM enables S-Band voice.
5. MSFN Relay Details (GET 44:22:00)

LM  $\xrightarrow{\text{S-Bd}}$  MSFN  $\xrightarrow{\text{Relay S-Bd}}$  CSM

- a. CMPs S-Band volume is increased (CSM).
- b. CSM VHF A is disabled.
- c. LM VHF A receiver is disabled.
- d. LM tape recorder is enabled.
- e. Voice communication between LM and CSM  $\approx$  one minute.  
(MSFN is relay.) Tape tb is gray.
- f. LM VHF A receiver is enabled.
- g. LM Recorder is set to off.
- h. LMPs audio is set to normal (LM).
- i. LM S-Band volume is fully decreased.
- j. CSM VHF A is set to simplex.
- k. CSM S-Band volume is fully decreased.

\*Note: LM Activation and Checkout.

C. Procedural Reference

Procedures preceding this period are identified in the Communications Plan on page 5-2\*.

D. Data Requirements

1. MSFN records CSM Relay voice (M)
2. MSFN records LM Relay voice (M)
3. LM records MSFN Relay voice (M)

E. Crew Logging/Recording Requirements

None

\*Note: LM Activation and Checkout.

## PLSS COMMUNICATION CHECKS

### A. DTO Reference

1. P20.21 - LM/MSFN S-Band Performance
2. P20.22 - LM/CSM/MSFN Communication Compatibility

### B. Test Details

1. Checkout of the EMU with LM 2-way relay. [P20.22]  
(GET 46:23:00)

EMU Voice, Biomed  $\xrightarrow{\text{VHF}}$  LM  $\xrightarrow{\text{S-Band}}$  MSFN & return

- a. LM is configured to LM 2-way relay.
  - b. PLSS Mode 5 is selected.
  - c. CSM is configured for LM 2-way relay:  
DUPLIX A, RCV ONLY A
2. TV data (Signal Combination Mode 10) [P20.21]
    - a. This mode will consist of S-Band with HBR data and voice on FM with high S-Band amplifier power.
    - b. Five minutes of total data and two minutes of continuous data are required.
    - c. Upon completion of TV operation the LM will reconfigure to the CSM 1-way down relay mode.
  3. Signal Combination Mode 7 (Lunar Stay with Relay) [P20.21]  
(GET 46:33:00)
    - a. This mode consists of LM S-Band voice, relay, H.L. biomed, EMU, LBR PCM, and low S-Band amplifier power.
    - b. Two minutes total data are required.
  4. Signal Combination Mode 8 (Lunar Stay with Relay Backup)  
[P20.21] (GET 46:38:00)
    - a. This mode consists of S-Band backup voice, relay, EMU, H.L. biomed, LBR PCM and low S-Band amplifier power.
    - b. Two minutes total data are required.

### C. Procedural Reference

1. AOH LMA 790-3-LM-3, Section 4.13.2.2, "Relay Mode, EVA."
2. TV operation will be per the D-Mission Photo Operations Plan, Section IV, TV Plan, published by Flight Crew Support Division, MSC.
3. Communications configurations before and after these checks are identified in the Communications Plan, Section 5, of this document.

D. Data Requirements

1. MSFN recording of EMU to MSFN voice & biomed (via LM relay) (M) [P20.22]
2. EMU voice on LM tape recorder (M) P20.22
3. EMU voice on CSM DSE and MSFN playback (M) [P20.22]
4. EMU biomed data relayed to MSFN (M) [P20.21]
5. MSFN recording of video tape (M) [P20.21]
6. MSFN assessment of video quality. [P20.21]
7. MSFN records of acquisition times for omni antennas (M) [P20.21]
8. MSFN recording of LM to MSFN voice (M) [P20.21]
9. MSFN S-Band tracking data processor output (M) [ P20.21]
10. MSFN recording of telemetry bit stream (M) [P20.21]

E. Crew Logging/Recording Requirements

Crewman's comments as to voice quality of MSFN up-voice via LM VHF, and via CSM VHF through S-Band (M) [P20.21] [P20.22]

LM PIPA BIAS TEST

A. DTO Reference

P11.10 - PGNC'S IMU Performance

B. Test Details

1. LGC must be powered up during test.
2. Allow PIPA counts for minimum of 32 seconds during test (to telemetry).
3. Spacecraft in free drift.
4. Astronaut motions minimal.
5. The test is conducted at the following times:
  - a. Prior to the docked DPS burn (GET 47: 40: 00)
  - b. Prior to the rendezvous (GET 91: 40: 00)
  - c. After the rendezvous (GET 100: 05: 00)

C. Procedural Reference

PIPA Bias Measurement and Loading, Section 4.6.1.16,  
AOH LMA 790-3-LM3

D. Data Requirements

LM HBR (M)

E. Crew Logging/Recording Requirements

None

## LANDING RADAR SELF TEST

### A. DTO Reference

1. P16.6 - Landing Radar Self Test
2. M16.7 - Prerequisite to LR Spurious Test

### B. Test Details [P16.6]

1. Select HI MULT (panels 1 & 3) for the X-pointer scale.
2. Select LDG RDR/CMPTR on RATE/ERR MON sw's (panels 1 & 2).
3. Select LDG on RADAR TEST sw to perform self test.
4. Perform the self test before and after, but not during, DPS burns as follows:
  - a. Prior to the Docked DPS Burn (GET 48 : 16 : 00)
  - b. After the Docked DPS Burn (GET 50 : 00 : 00)
5. It is desired but not mandatory that the self-test be performed prior to and after each rendezvous DPS burn. (GET 91: 53: 00, 94: 15: 00)
6. Read the altimeter and velocity transmitters RF power output prior to and after each self-test. (Not implemented after self-test)

Note - Test is performed in conjunction with the LR spurious test and is associated with the same burns. [M16.7]

### C. Procedural Reference

Landing Radar Checkout, Section 4.6.3.4  
AOH LMA -90-3-LM3

### D. Data Requirements [P16.6]

1. LM HBR (M)
2. LM DFI (HD)

### E. Crew Logging/Recording Requirements (M) [P16.6]

1. LR Vel and Alt transmitter RF power output from Sig Strength meter prior to each self-test.
2. LR X-axis velocity (or alt rate) from RANGE RATE/ALT RATE meter during each self-test.
3. LR Y-axis velocity from X-Pointers during each self-test.
4. LR Z-axis velocity from X-Pointers during each self-test.
5. LR altitude data from RANGE/ALT meter during each self-test.
6. LR Vel and Alt transmitter RF power output from Sig Strength meter after each self-test.

AGS INITIALIZATION

A. DTO Reference

P12.2 - AGS Initialization

B. Test Details

1. Perform AGS Initialization Routine via V47E each time AGS system is put in operate condition. (GET 48:27:00, 91:42:00)

2. There are no special procedures.

C. Procedural Reference

AGS Initialization Routine (R47), Section 4.6.1.18, AOH LMA 790-3-LM3

D. Data Requirements

None

E. Crew Logging/Recording Requirements

None

## AGS CALIBRATION

### A. DTO Reference

Pl2.2 - AGS Gyro and Accelerometer Calibration

### B. Test Details

#### 1. LM attitude rotation rates not to exceed:

- (a) 0.2 degree/second when unstaged
- (b) 0.6 degree/second when staged

#### 2. Test is conducted at the following times:

- (a) Each time PGNCs and AGS are put in operate (GET 48:30:00, 91:45:00)
- (b) Before PGNCs controlled docked DPS burn (GET 48:30:00)
- (c) Within 30 minutes after PGNCs controlled docked DPS burn (GET 49:50:00)
- (d) Prior to LM separation from CSM (GET 91:45:00)
- (e) As operationally required during Rendezvous (none required)

NOTE: AGS calibration automatically aligns AGS to PGNCs

### C. Procedural Reference

AGS Calibration, Section 4.6.2.5, AOH LMA 790-3-LM3

### D. Data Requirements

None

### E. Crew Logging/Recording Requirements

- 1. Record DEDA X, Y, Z accelerometer bias after each AGS calibration (M unless HBR T/M available):
  - (a) X<sub>accel</sub>, Key DEDA C 540 R \_\_\_\_\_ (octal)
  - (b) Y<sub>accel</sub>, Key DEDA C 541 R \_\_\_\_\_ (octal)
  - (c) Z<sub>accel</sub>, Key DEDA C 542 R \_\_\_\_\_ (octal)
- 2. Record DEDA X, Y, Z gyro drift after each AGS calibration (M unless HBR T/M available):
  - (a) X<sub>drift</sub>, Key DEDA C 544 R \_\_\_\_\_ (0.01°/hr)
  - (b) Y<sub>drift</sub>, Key DEDA C 545 R \_\_\_\_\_ (0.01°/hr)
  - (c) Z<sub>drift</sub>, Key DEDA C 546 R \_\_\_\_\_ (0.01°/hr)



DOCKED DPS BURN (GET 49 : 42 : 00)

A. DTO Reference

1. P11.5 - Data Collection for Determination of LM IMU Inflight Align Accuracy
2. M11.6 - DPS Burn Including Manual Throttling
3. P11.10 - Data for CSM and LM IMU Performance
4. P12.2 - Data for AGS Calibration and performance
5. M13.12 - DPS Burn of 200 seconds at FTP
6. M16.7 - Operate Landing Radar in Position 1 during a DPS Burn
7. M17.9 - Landing Gear Temperature Data and Observed Exhaust Impingement.
8. M17.17 - 3 Sec of LM RCS Ullage Burn and a Long DPS Burn at FTP
9. M17.18 - LM Structural Integrity during DPS Burns
10. S20.32 - LM and CM Acoustical Environment During DPS Burn
11. S20.37 - Observe and Photograph DPS Plume

B. Test Details

1. LR Self Test is conducted prior to burn [M16.7]
2. PGNCs is aligned prior to burn. [M11.6] [P12.2]
3. GNCs is fine aligned using optics prior to burn. [M11.6]
4. AGS is aligned to PGNCs 5 minutes prior to burn. [M11.6]  
(Not implemented)
5. MODE SELECT sw (Pnl 1) - Ldg Radar
6. LR antenna position 1 is selected. [M16.7]
7. LM LR spurious test routine is selected. [M16.7]
8. DPS burn is performed using P40.
9. Burn Parameters  
Ullage: 10 sec  
DPS Burn duration: 367 sec  
1714.1  
Guidance: PGNCs - Ext  $\Delta V$
10. Burn profile is as follows: (covers requirements for M11.6, b thru o)  
NOTE: Throttle Control AUTO until VG = 124 fps
  - a) TIG - 10 sec: Ullage, 2-jet, System B (M17.14 4-jet ullage not implemented)
  - b) TIG = 0: Engine on (10%)
  - c) TIG + 5 sec: Manual throttle to 40%
  - d) TIG + 26 sec: Auto throttle to FTP (covers requirements for M13.12)
  - e) VG = 124 fps (TIG +  $\approx$  306 sec): Throttle control to MANUAL (40% thrust)
  - f) 2 sec: 40% thrust
  - g) 5 sec: Ramp to 10% throttle
  - h) 5 sec: 10% thrust
  - i) 5 sec: Ramp to 40% throttle
  - j) 5 sec: 40% thrust
  - k) 2 sec: Ramp to 25% throttle

- l) 5 sec: 25% thrust
- m) 2 sec: Ramp to 40% throttle
- n)  $\approx$  30 sec @ 40% thrust
- o) Tgo = -3 sec: Manual engine shutdown

12. Take pictures using the sequence camera focusing through the DPS plume. [S20.37]

C. Procedural Reference

- 1. Landing Radar Spurious Test Routine, Section 4.6.3.10, AOH LMA 790-3-LM3
- 2. DPS Thrust Program (P40), Section 4.10.1, AOH LMA 790-3-LM3

D. Data Requirements

- 1. CSM HBR (M) [M11.6]
- 2. LM HBR (M) [M11.6] [P12.2] [M13.12] [M16.7] [M17.9] [M17.17]
- 3. LM DFI (M) [M11.6] [M13.12] [M16.7] [M17.9] [M17.17]
- 4. Photography of the DPS plume (HD) [S20.37]
- 5. MSFN best estimate of trajectory during burn (M) [P11.5] [M11.6] [P11.10] [M17.17]
- 6. MSFN tracking data 60 seconds prior to and 60 seconds after the burn (HD) [P11.5]

E. Crew Logging/Recording Requirements

- 1. Comment on the visual effects of the DPS plume (M) [S20.37]
- 2. Record LR temperature at the end of the burn (HD) [M16.7]
- 3. Record LR temperature at the end of the burn +2 minutes. (HD) [M16.7]
- 4. Subjective comments on CSM and LM acoustical environment (M) [S20.32]
- 5. Observable effects of engine exhaust impingement on landing gear (M) [M17.9]
- 6. Narrative describing LM dynamic responses during DPS burn (M) [M17.17]

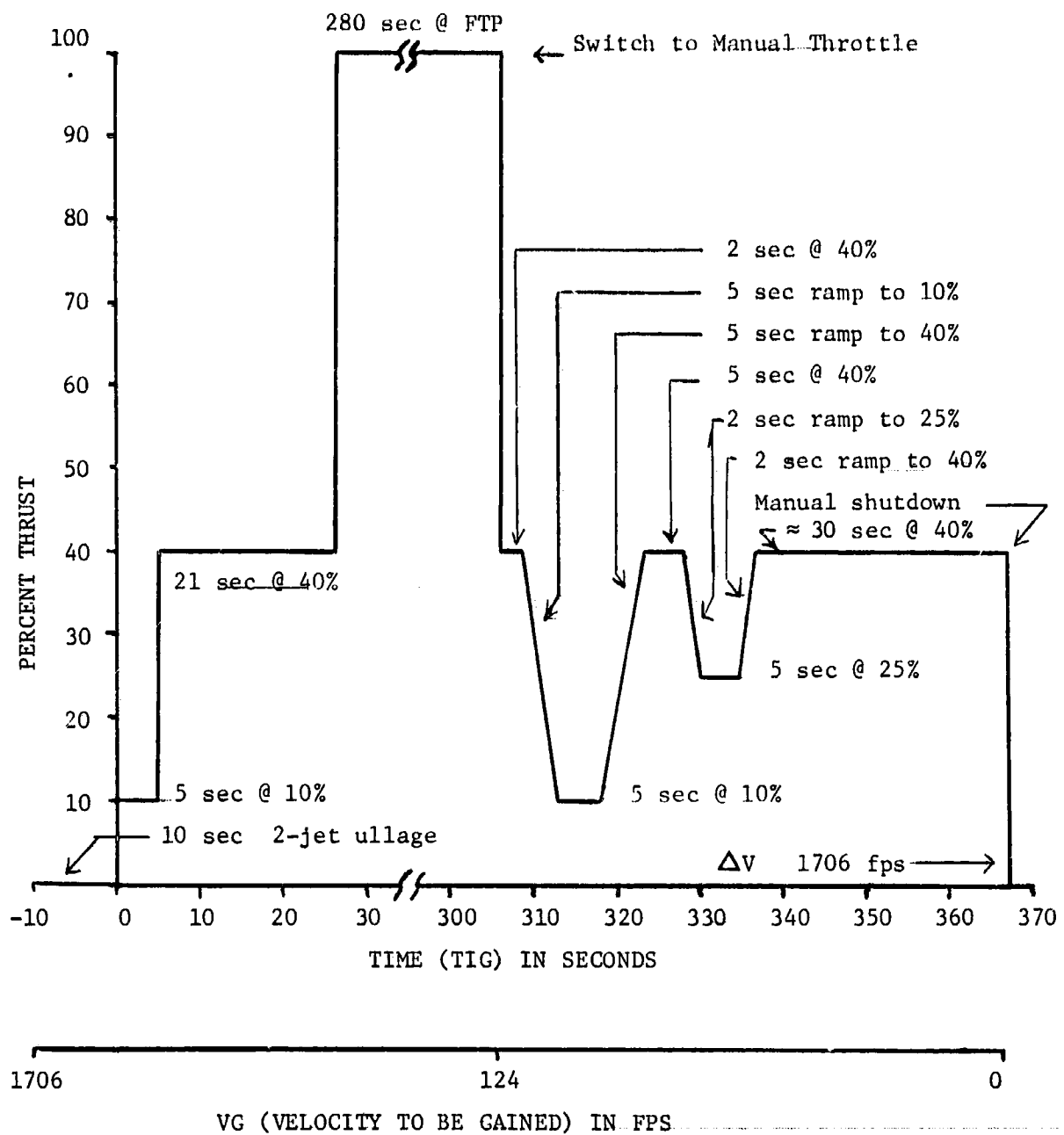

DPS BURN PROFILE FOR DOCKED DPS BURN

TUNNEL CLEARING - TWO CREWMEN IN LM (GET 49 : 55: 00)

A. DTO Reference

1. S20.32 - Tunnel Clearing
2. P20.34 - Crew Transfer to CM

B. Test Details

1. Crew fully suited with PGA unpressurized [P20.34]
2. Tunnel pressurized [P20.34]
3. CM/LM hard docked [P20.34]
4. Two crewmen in LM and one crewman in CM [P20.34]
5. Photograph a crewman transfer to CM [S20.32]

C. Procedural Reference

1. Open Overhead Hatch (LM Side) Section 4.14.7, and Remove Drogue (LM Side) Section 4.14.13  
AOH LMA 790-3-LM3
2. Remove Docking Probe (CSM Side) Section 4.5.4.1  
AOH-SM2A-3-SC104 - (2)

D. Data Requirements

Photography of a crewman transfer (HD) [S20.32]

E. Crew Logging/Recording Requirements

1. Time required for crewmen to clear the tunnel working from both the CM and the LM (M) [P20.34]
2. Time required for one crewman to IVT to the CM from leaving the LM work station to ingress into the CM (M) [P20.34]
3. Comments on clearing the tunnel (M) [P20.34]
4. Comments on stowing tunnel equipment on the aft bulkhead (M) [S20.32]

SUBLIMATOR DRYOUT (GET 50: 24: 00)

A. DTO Reference

M14 - Sublimator Dryout

B. Test Details

No special test details

C. Procedural Reference

Sublimator Dryout, Section 4.3.1,  
AOH LMA 790-3-LM3

D. Data Requirements

1. LM LBR (M)
2. LM HBR (HD)
3. LM DFI (M)

Notes: All telemetry data are required for 5 minutes at the start of sublimator dryout. Telemetry coverage to verify complete shutdown will be collected over statics along with data from other functions.

E. Crew Logging/Recording Requirements

None \_\_\_\_\_

EVA (GET 73: 07: 00)

A. DTO Reference

1. S7.29 - Retrieve CSM Sample and Photograph CSM Radiators
2. M14 - LM Depressurization, Repressurization and PLSS Recharge
3. M17.17 - Retrieve Samples from the Exterior of the LM and Take Photographs
4. P20.25 - Still Photography of LM Exterior
5. S20.32 - Pressurized PGA in a Depressurized Cabin
6. P20.35 - Extravehicular Activity

B. Test Details

Total activity for the EVA period has been published in an EVA procedures document for both the LM and the CSM. The document has incorporated the requirements specified in the above referenced DTO's.

C. Procedural Reference

1. Final EVA Procedures Mission D, 20 Nov 1968.
2. Feedwater Reservoir Recharge, Section 4.15.15.4, AOH LMA 790-3-LM3

D. Data Requirements

1. LM HBR (HD) As station coverage permits [M14]
2. LM DFI (HD) As station coverage permits. [M14]
3. LM LBR (M) as follows: [M14]
  - a. Five minutes, beginning at start of O<sub>2</sub> recharge (PLSS)
  - b. Five minutes, beginning at start of H<sub>2</sub>O recharge (PLSS)
  - c. Five minutes, beginning at start of cabin depressurization
  - d. Five minutes, beginning at start of cabin repressurization
4. EMU data to CSM is relayed to MSFN whenever ground coverage is available. (M) [P20.35]
5. Photography
  - a. Sequence camera coverage of EVA transfer path from both the LM and CM (HD) [P20.35]
  - b. Still photos taken by EVA crewman of +Y axis of CSM EPS and ECS radiators (3HD) [S7.29]
  - c. Still photos of LM descent stage RCS impingement (1M, 2HD) [P20.25] [M17.17]
6. Obtain four thermal samples from CSM external locations. (HD) [S7.29]
7. Obtain one thermal sample from LM external location. (HD) [M17.17]

E. Crew Logging/Recording Requirements

1. Mark start and end of LM depressurization. (M) [P20.35]
2. Mark start and end of CM depressurization. (M) [P20.35]
3. Mark start and end of LM crewman to open LM forward hatch. (M) [P20.35]
4. Mark start and end of CMP's opening CM side hatch (M) [P20.35]
5. Mark start and end of EVA crewman's transfer from LM forward hatch to CM side hatch. (M) [P20.35]
6. Mark start and end of EVA crewman's closing CM side hatch from inside (M) [P20.35]
7. Crew comments on adequacy of EVT procedures and hardware provisions including illumination aids (M) [P20.35]
8. Comment on observable RCS exhaust impingements. (HD) [P20.35]
9. Mark start and end of LM crewman to close LM forward hatch. (M) [P20.35] (not implemented)
10. Mark start and end of CMP's closing CM side hatch. (M) [M20.35]
11. Mark start and end of LM repressurization. (HD) [P20.35]
12. Mark start and end of CM repressurization. (M) [P20.35]
13. GET at start and completion of O<sub>2</sub> recharge (HD) [M14]
14. GET at start and completion of H<sub>2</sub>O recharge (HD) [M14]
15. Subjective comments on recharging PLSS (HD) [M14]
16. Narrative describing effects on crewman performance of wearing hard suit in depressurized cabin (M) [S20.32]

NOTE: All objectives required by DTO P20.35 are considered principle objectives except those concerned with EVT, which are considered secondary.

## EVA COMMUNICATIONS TEST

### A. DTO Requirements

P20.22 - Voice and EMU Biomed Data

### B. Test Details

1. CSM 1-Way Down Relay [P20.22] (GET 71:23:00)

Voice, EMU Biomed  $\xrightarrow{\text{VHF RELAY S-BAND}}$  CSM  $\xrightarrow{\text{S-BAND}}$  MSFN

2. Voice: EMU  $\xrightarrow{\text{VHF}}$  LM and EMU  $\xrightarrow{\text{VHF}}$  CSM [P20.22]

Note: This objective is satisfied by normal EVA communications.

### C. Procedural Reference

CSM and LM communications modes during EVA are described on page 5-3 of the Communications Plan, Section 5. of this document.

### D. Data Requirements

1. EMU biomed data relayed to MSFN (M) [P20.22] \_\_\_\_\_
2. CSM HBR (HD) [P20.22]
3. LM DFI (HD) [P20.22] (not implemented)
4. LM HBR (HD) [P20.22]

### E. Crew Logging/Recording Requirements

1. EVA crewman's comments on CSM to EVA voice (M) [P20.22]
2. EVA crewman's comments on LM to EVA voice (M) [P20.22]



LM LiOH CARTRIDGE REMOVAL (GET 76:17 : 00)

A. DTO Reference

M14 - Primary and Secondary Cartridge Removal

B. Test Details

There are no special test details.

C. Procedural Reference

1. Primary LiOH Cartridge Replacement, Section 4.13.1.6, AOH LMA 790-3-LM3,
2. Secondary LiOH Cartridge Replacement, Section 4.13.1.7, AOH LMA 790-3-LM3,

D. Data Requirements

1. LM HBR (HD)
2. LM LBR (M)
3. LM DFI (HD)

E. Crew Logging/Recording Requirements

1. GET at start and completion of primary cartridge replacement (HD)
2. GET at start and completion of secondary cartridge replacement (HD)
3. Subjective comments on removal procedures (HD)

RENDEZVOUS RADAR SELF TEST (GET 91:58:00)

A. DTO Reference

P16.4 - Rendezvous Radar Self Test

B. Test Details

1. LM configuration undocked and unstaged within station keeping distance of CSM (not implemented)
2. Self test to be performed prior to tracking performance test

C. Procedural Reference

Rendezvous Radar Checkout, Section 4.6.3.5, AOH LMA 790-3-LM3

D. MSFN Data Requirements

LM HBR (M)

E. Crew Logging/Recording Requirements

Record radar signal strength of the following (M)

- a. AGC
- b. Shaft ERR
- c. XMTR PWR
- d. TRUN ERR

LM/CSM UNDOCKING AND INSPECTION (GET 92:39 :00 )

A. DTO Reference

1. M17.9 - Landing Gear Photography
2. M17.18 - Undocking Photography
3. P20.25 - Still Photography of LM Exterior
4. P20.26 - LM/CSM Undocking

B. Test Details

1. Vehicles will be undocked during daylight. [P20.26]
2. Sequence camera mounted in left hand rendezvous window of CSM [M17.18]
3. CSM sequence camera photography will record drogue condition immediately after undocking. [P20.26] Photograph one upper outrigger at  $\approx$  10 feet [M17.18]
4. LM will maneuver to allow the CSM to photograph the following LM surfaces at a distance of  $\approx$  45 feet using Hasselblad with 80mm lens and SO 121 film.
  - a. Top view - normal to the LM tunnel, parallel to the +X axis [M17.18]
  - b. Right side view - normal and parallel to the +Y axis [M17.18]
  - c. Front view - normal to the forward hatch, parallel to the +Z axis [M17.18]
  - d. Left side view - normal and parallel to the -Y axis [M17.18]
  - e. Rear view - normal and parallel to the -Z axis [M17.18]
  - f. Bottom view - normal to the DPS exhaust nozzle, parallel to the -X axis [M17.18]
  - g. Additional pictures will be taken during LM maneuvers to show:
    - Four LM lunar surface sensing probe indicators [M17.9]
    - Eight LM landing gear downlock indicators [M17.9]

C. Procedural Reference

1. LM Separation from CSM, Section 4.5.1.5, AOH SM2A-03-SC104 (2)

D. Data Requirements

1. LM HBR during undocking (M) [P20.26]
2. CSM HBR during undocking (M) [P20.26]
3. Photography of drogue condition immediately after undocking (HD) [P20.26]
4. Photography of upper outrigger. One is (M); two or more (HD) [M17.18]
5. Photography of each of six principal LM views as described in B.3. a through f. One photograph of each view is (M); two or more is (HD) [M17.18]
6. Photography of sensing probe indicators as described in B.3.g (M) [M17.9] [P20.25]
7. Photography of landing gear downlock indicators as described in B.3.g. (M) [M17.9] [P20.25]

E. Crew Logging/Recording Requirements

1. Probe total travel time (initiation to full travel) as indicated by the flight annunciators (M) [P20.26]
2. Comments concerning vehicle dynamics and separation rates (M) [P20.26]

LM/CSM UNDOCKING AND INSPECTION PHOTOGRAPHY

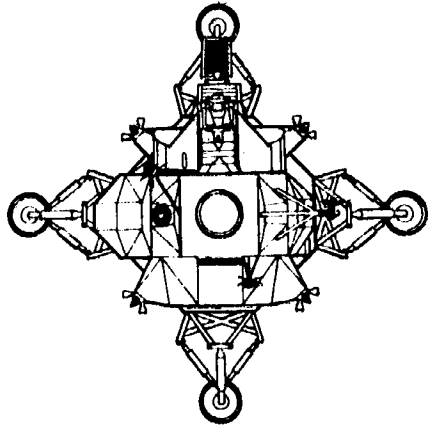

TOP VIEW +X AXIS

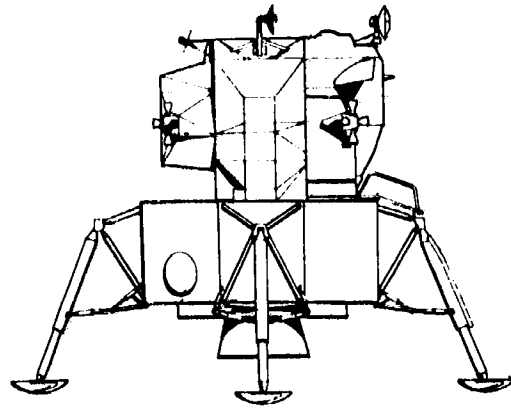

RIGHT SIDE VIEW +Y AXIS

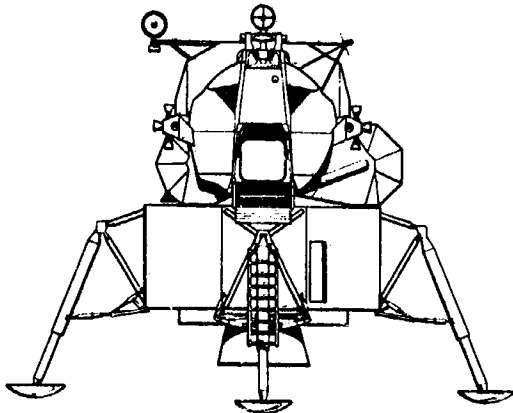

FRONT VIEW +Z AXIS

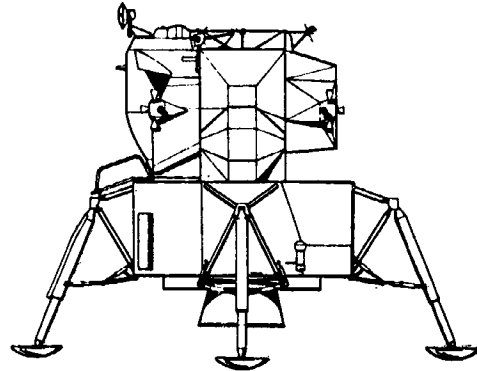

LEFT SIDE VIEW -Y AXIS

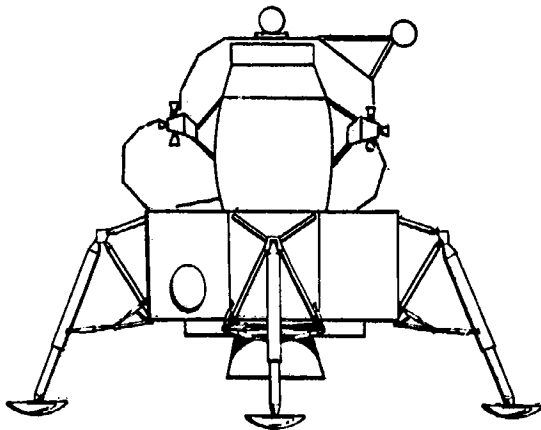

REAR VIEW -Z AXIS

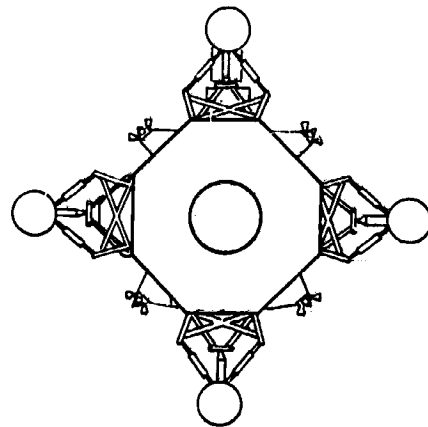

BOTTOM VIEW -X AXIS

## LM AGS ATTITUDE CONTROL

### A. DTO Reference

Plz.3 - AGS/UES Attitude Control

### B. Test Details

1. LM configuration is undocked and unstaged.
2. Tests may be conducted as a normal exercise in performing the mission as follows:

- a. Minimum deadband auto attitude hold (GET 92:47:00)
- b. Maximum deadband auto attitude hold (GET 92:56:00)
- c. Pulse mode attitude control (GET 92:53:00)
- d. Direct command attitude maneuver (Not implemented)
- e. Proportional rate command attitude control (GET 93:48:00)
- f. Auto attitude maneuver (not implemented)

Note: Tests B.2.a. and b. Rates  $> 1^\circ/\text{sec}$  in one axis (M), in all axes (HD) prior to start of hold. Hold will be maintained through one zero-error crossing cycle (+) in each axis. (1.5 minutes minimum deadband, 5.0 minutes maximum dead band).

### C. Procedural Reference

1. AGS Attitude Hold/Rate Cmd., Section 4.5.1.6 (Tests B.2.a., B.2.b., B.2.e.),
2. AGS Pulse, Section 4.5.1.7 (Test c.),
3. AGS Direct, Section 4.5.1.8 (Test d.),
4. AGS Automatic, Section 4.5.1.5 (Test e.),  
AOH LMA 790-3-LM3,

### D. Data Requirements

1. LM HBR (M)
2. Continuous TM coverage for a minimum of 1.5 min (Test B.2.a.), and 5 min (Test B.2.b) (M)

### E. Crew Logging/Recording Requirements

1. Initial body rates prior to attitude hold (M unless available on HBR TM) (Tests B.2.a, B.2.b.)
2. Time attitude hold demonstration periods being (M), and time interval of attitude error zero crossings in each axis (M unless available on HBR TM) (Tests B.2.a.B.2.b)
3. Describe success of manual attitude control modes. (M) (Tests B.2.c., B.2.d., B.2.e.)
4. FDAI inertial attitude prior to and at the conclusion of the automatic maneuver (M unless available on HBR TM) (Test B.2.f.)
5. Any information regarding unusual torques or venting (M)

## LM IMU ALIGNMENTS

### A. DTO Reference

P11.5 - LM AOT Alignments

### B. Test Details

1. The following pertain to each test:
  - a. Any of the four alignment options may be used.
  - b. Prior to AOT aligns, perform coarse alignment using docking ring calibration marks.
  - c. Obtain a minimum of three and a maximum of five sets of marks for each star sightings.
2. The following pertain to individual tests:
  - a. Vehicle may be docked or undocked; a minimum of three AOT alignments are required. (GET 93: 19: 00, 94: 53: 00, third not implemented)
  - b. It is desirable that all of the forward detent positions be used: FWD, Left and Right
  - c. At least one alignment in daylight is desirable. (not implemented)
  - d. Perform two AOT alignments  $\geq$  one hour apart with no intervening  $\Delta V$  maneuver to check gyro drift. (not implemented)
  - e. LM IMU align precedes docked DPS burn. (GET 49: 10: 00)

### C. Procedural Reference

Docked Manual IMU Coarse Alignment, Section 4.9.1.5;  
IMU Realignment Program (P52), Section 4.9.1.2;  
AOH LMA 790-3-LM3

### D. Data Requirements

LM HBR during actual star marking (M)

### E. Crew Logging/Recording Requirements

1. AOT detent position (M)
2. Align start time (M)
3. Star angle difference (M)
4. Gyro torquing angles (M)
5. Align end time (M)
6. Comments on displays, controls and procedures (M)

LM COAS CALIBRATION CHECK (GET 93 : 30 : 00)

A. DTO Reference

P11.5 - Obtain COAS Accuracy Data

B. Test Details

The recheck feature of the P52 program is used after an IMU alignment to perform the COAS calibration check as follows:

1. Select first alignment star and load 00000 azimuth and elevation in noun 87.
2. Perform an auto maneuver to the star selected and bypass trim.
3. Observe the star with the COAS and record azimuth and elevation angle errors. Note the position of the star when attitude error is zero.
4. Adjust noun 87
5. Restart selecting second star and using adjusted noun 87 azimuth and elevation.
6. Perform an auto maneuver, bypassing trim, to the second star and check azimuth and elevation angle errors with the COAS. Readjust noun 87 as required.
7. Repeat steps 1-6, if time permits, until errors are zero.
8. Bypass torquing and exit P52.

C. Procedural Reference

IMU Realign Program (P52), (using COAS option) Section 4.9.1.2, AOH  
LMA 790-3-LM3

D. Data Requirements

None

E. Crew Logging/Recording Requirements (M)

1. Stars selected for calibration check
2. Azimuth and elevation angle errors for each COAS sighting



EPS PREPARATION FOR A DPS BURN (GET 93 : 45 : 00)

A. DTO Reference

M15.3 - EPS Preparation for a DPS Burn

B. Test Details

Crewman EPS preparation for LM burns will include the following:

1. Operation of the backup inverter.
2. Operation of the ascent stage batteries as backup to the descent stage batteries. (Not implemented for docked DPS Burn)

C. Procedural Reference

EPS Preparation for DPS Burn, Section 4.13.4.3  
AOH LMA 790-3-LM3

D. Data Requirements

LM HBR (M) as MSFN coverage allows

E. Crew Logging/Recording Requirements

None

LM AGS MANUAL TRANSLATION (GET 93: 49: 55)

A. DTO Reference

P12.3 - AGS/CES Manual Translation

B. Test Details

1. LM configuration is undocked and unstaged.
2. Test will be conducted as a normal exercise in performing the mission requiring LM manual translation in any axis (: and -).

C. Procedural Reference

RCS Translation, Section 4.5.2.5, AOH LMA 790-3-LM3

D. Data Requirements

LM HBR (M)

E. Crew Logging/Recording Requirements

1. Describe success of manual translation control including observations of relative motion between the LM and optics target. (M)
2. Comments relevant to cross-coupling rotational effects as observed on FDAI(s) (M)
3. Any information regarding unusual torques or venting (HD)

RENDEZVOUS PHASING BURN (GET 93: 50: 03)

A. DTO Reference

1. P11.5 - Data Collection for Determination of LM IMU Inflight Align Accuracy
2. M11.6 - PGNCs Aligned Prior to First Undocked DPS Burn
3. P11.10 - Data for LM IMU Performance
4. P12.2 - Data for AGS Calibration
5. P12.4 - AGS  $\Delta V$  Capability Using DPS
6. M16.4 - Rendezvous Radar Tracking Performance during Burn
7. M16.7 - Operate LR in Position 2
8. M17.9 - Landing Gear Temperature Data on T/M
9. M17.18 - LM Dynamic Response during DPS Burn
10. P20.32 - LM Acoustics during the DPS Burn

B. Test Details

1. Targeting parameters input via DSKY using prethrust program (P30) [P12.4]
2. PGNCs aligned prior to burn [M11.6]
3. Descent stage propellant loading > 65 percent of capacity is highly desirable [P12.4]
4. Rendezvous radar self test performed prior to operating RR. [P16.4]
5. AGS aligned to PGNCs 5 minutes prior to burn [M11.6] (not implemented)
6. LR self test conducted prior to burn [M16.7]
7. LR antenna hover position is selected [M16.7]
8. LM spurious test routine is selected [M16.7]
9. DPS burn is AGS controlled with PGNCs monitoring in DPS thrusting program (P40) [P12.4]
10. RR lock-on is automatically maintained during the burn. [P16.4]
11. Observe for false landing gear lock-on by monitoring the LDG RDR caution light, the LR altitude indicator remaining constant, and the alt. rate indicator remaining at zero [M16.17] (not implemented)
12. Burn Parameters  
Ullage: 7 sec (2 jet System B)  
Burn Duration: 24.9 sec  
 $\Delta V$ : 85.0 fps  
Guidance: AGS - Ext  $\Delta V$  (PGNCs/RCS trim)  
Profile: 10% thrust for 15 sec; 40% thrust for 10.2 sec

C. Procedural Reference

DPS Thrust Program (P40), Section 4.10.1, AOH LMA 790-3-LM3

D. Data Requirements

1. LM HBR (M) [M11.6] [P12.2] [P12.4]
2. LM DFI (M) [M11.6] [M17.18]
3. MSFN best estimate of trajectory for burn (M) [P11.5] [M11.6]  
[P11.10] [P12.4] [M17.18]

E. Crew Logging/Recording Requirements

1.  $V_g$  preburn (HD) [P12.4]
2. Ullage initiation time (HD) [P12.4]
3. Command thrust level at 10% (HD) [P12.4]
4. Engine thrust level at 10% (HD) [P12.4]
5. Command thrust level at 40% (HD) [P12.4]
6. Engine thrust level at 40% (HD) [P12.4]
7. DPS Shutdown time (HD) [P12.4]
8.  $V_g$  after shutdown (HD) [P12.4]
9. Narrative describing LM dynamic responses during DPS burn (M)  
[M17.18]
10. Subjective comments on LM acoustical environment during burn (M)  
[S20.32]
11. Crew comments on handling characteristics including any unusual  
att/rate transients (M) [P12.4]
12. Record LR temperature at the end of the burn and two minutes  
after the end of the burn. \_\_\_\_\_

LM AOT NIGHTTIME STAR OBSERVATION - S-BAND STEERABLE ANTENNA  
(not implemented)

A. DTO Reference

P11.5 - LM AOT Nighttime Star Observation - S-Band Steerable

B. Test Details

1. Perform test during any night time pass.
2. LM is undocked.
3. Select AOT right rear detent position.
4. Position S-Band steerable antenna to a pitch angle of 90° and a yaw angle of 0°.
5. Observe star field with LM tracking light off.
6. Observe star field with LM tracking light on.
7. During observation with LM tracking light on, slew the S-Band antenna  $\pm 10^\circ$  in the spacecraft XZ plane.

C. Procedural Reference

None

D. Data Requirements

None

E. Crew Logging/Recording Requirements

1. Identify the dimmest star observed with the tracking light ON and OFF (M)
2. Comments on flashing light visibility in AOT (M)
3. Comments on flashing light degradation of star field observation (M)
4. Comments as to the portion of the observed star field that was degraded and direction of light that caused degradation. (M)

LM AOT NIGHTTIME STAR OBSERVATION - RR  
(not implemented)

A. DTO Reference

PL1.5 - LM AOT Nighttime Star Observation - RR

B. Test Details

1. LM is undocked.
2. Perform during any nighttime pass.
3. Select AOT forward detent position.
4. Select Rendezvous Radar Antenna shaft position of  $35^{\circ} \pm 5^{\circ}$  (up).
5. Observe star field with LM tracking light off.
6. Observe star field with LM tracking light on.

C. Procedural Reference

None

D. Data Requirements

None

E. Crew Logging/Recording Requirements

1. Identify the dimmest star observed with the tracking light ON and OFF (M)
2. Comments on flashing light visibility in AOT (M)
3. Comments on flashing light degradation of star field observation (M)
4. Comments on whether the pulsating illumination was constant over the entire field of the AOT and, if not, from which direction the light emanated (M)

RENDEZVOUS INSERTION BURN (GET 95: 41: 48)

A. DTO Reference

1. P11.5 - Data Collection for Determination of LM IMU Inflight Align Accuracy
2. M11.6 - PGNC S Controlled Undocked DPS Burn with 10% Throttle
3. P11.10 - Data for LM IMU Performance
4. M13.12 - Undocked DPS Burn at 10% Throttle
5. M17.9 - Landing Gear Temperature Data on TM
6. M17.18 - LM Dynamic Response during DPS Burn
7. S20.32 - LM Acoustics during DPS Burn
8. S20.37 - Observe the DPS Plume

B. Test Details

1. AGS aligned to PGNC S 5 minutes prior to burn (not implemented) [M11.6]
2. DPS Propellant tank 1/3 to 2/3 full [M11.6]
3. DPS Burn is performed using P40.
4. Burn Parameters:
  - Ullage: 7 sec (2 jet System B)
  - DPS Burn Duration: 24.4 sec
  - $\Delta V$ : 39.9 fps
  - Guidance: PGNC S - Ext  $\Delta V$
  - Profile: 10% thrust for 24.8 sec; [M11.6]

C. Procedural Reference

DPS Thrust Program (P40) with AGS followup, Section 4.10.1,  
AOH LMA 790-3-LM3

D. Data Requirements

1. LM HBR (M) [M11.6]
2. LM DFI (M) [M11.6] [M17.18]
3. MSFN Best estimate of trajectory for burn (M) [P11.5] [M11.6] [P11.10]

E. Crew Logging/Recording Requirements

1. Subjective comments on LM acoustical environment (M) [S20.32]
2. Comments on the visual effects of the DPS plume on viewed objects (M) [S20.37]
3. Narrative describing LM dynamic responses during DPS burn (M) [M17.18]

RENDEZVOUS RADAR TRACKING TEST (GET 97: 00: 00)

A. DTO Reference

P16.4 Rendezvous Radar Tracking Test

B. Test Details

1. Test will be preceded by a satisfactory rendezvous radar self test.
2. Test will be performed during LM/CSM separation and subsequent rendezvous.
3. Establish LM/MSFN communications. Activate rendezvous radar & acquire lock within station keeping distance. Break lock at any range >50.8 nm and verify dropout before RR search and reacquisition of lock.

C. Data Requirements

1. CSM LBR (M during radar reacquisition)
2. LM HBR (M) prior to 50.8 nm going out, after 50.8 nm, and the same coming back in
3. MSFN will provide trajectory tracking data during rendezvous for post-mission analysis. (M)

D. Procedural Reference

None

E. Crew Logging/Recording Requirements

1. Range data and GET twice/minute for five consecutive minutes when LM-CSM range is less than 50.8 nm, and once/minute for five consecutive minutes when LM-CSM range is greater than 50.8 nm for:
  - a. LM Pos RR Range (Transponder Mode) (M)
  - b. LM Vel RR Range Rate (PRF) (M)
2. GET + 1 sec when RR NO TRACK lt turns ON and OFF (M)
3. GET when RR transponder AGC signal decreases to zero as RR lock is deliberately broken, and again as lock is subsequently obtained and signal increases perceptibly (M)
4. Crew narrative describing any change in the RR NO TRACK lt and in the range and range rate data (M)



RENDEZVOUS COMMUNICATIONS TESTS  
(performed throughout rendezvous)

A. DTO Reference

P20.22 - CSM And LM Voice and Data Transmission via S-Band

B. Test Details

1. CSM and LM are undocked.
2. Voice and telemetry data transmission:

CSM  $\xrightarrow{\text{S-Bd}}$  MSFN & LM  $\xrightarrow{\text{S-bd}}$  MSFN; voice return

3. CSM and LM communication configurations for the rendezvous are described on page 5-4 of the Communications Plan.

C. Procedural Reference

Procedures used during the period are identified in the Communications Plan on page 5-4.

D. Data Requirements

1. PCM LBR and HBR from LM to MSFN (M)
2. PCM LBR and HBR from CSM to MSFN (M)
3. MSFN recording of both CSM dump and LM direct PCM stream - LM LBR data (M)
4. S-Band voice to MSFN (HD)

E. Crew Logging/Recording Requirements

None

Note: CSM to LM voice recorded on LM tape recorder (M), and LM to CSM voice recorded on CSM DSE (M), will be obtained during the normal communications for the rendezvous period.

EPS PRESTAGING CHECK (GET 96:16 : 00)

A. DTO Reference

M15.3 - Prestaging Check

B. Test Details

Preparations for staging include the following:

1. Operation of the deadface relay without load
2. Operation of ascent stage batteries as backup to the descent stage batteries
3. Parallel operation of descent stage batteries with the ascent stage batteries

C. Procedural Reference

EPS Prestaging Check Section 4.12.4  
AOH LMA 790-3-LM3

D. Data Requirements

LM HBR (M)

E. Crew Logging/Recording Requirements

None

APS CDH BURN (GET 97: 06: 22)

A. DTO Reference

1. P11.5 - LM Inflight IMU Align Accuracy Data
2. P11.10 - Data for LM IMU Performance
3. M17.18 - DFI and Tracking Data for APS Burn
4. S20.32 - Acoustical Environment During APS Burn

B. Test Details

1. Perform APS Burn Program P42
2. Burn Profile:
  - 4 jet, 4 sec RCS ullage
  - Burn duration: 2.9 sec
  - $\Delta V$ : 37.9 fps
  - Guidance: PGNC

C. Procedural Reference

APS Thrust Program (P42) with AGS Followup, Section 4.10.2  
AOH LMA 790-3-LM3

D. Data Requirements

1. LM DFI (M) [M17.18]
2. MSFN Best estimate of trajectory during the burn. (M)  
[M17.18] [P11.5] [P11.10]

E. Crew Logging/Recording Requirements

1. Subjective comments on LM acoustical environment during burn (M)  
[S20.32]
2. Narrative describing LM dynamic performance during the APS Burn (M)  
[M17.18]

LM PGNCB MANUAL TRANSLATION (GET 98. 00:15 )

A. DTO Reference

P11.7 - LM Manual Translation

B. Test Details

1. LM configuration is undocked, ascent stage only.
2. Test may be conducted as part of a normal mission activity requiring manual translation in any axis (+ and -).

C. Procedural Reference

RCS Translation, Section 4.5.2.5.  
AOH LMA 790-3-LM3

D. Data Requirements

PCM HBR (M)

E. Crew Logging/Recording Requirements

1. Describe success of PGNCB manual translation control (M)
2. Comments relevant to cross coupling rotational effects as observed on FDAI(s) (M)
3. Any information regarding unusual torques or venting (HD)

RENDEZVOUS DATA  
(THROUGHOUT RENDEZVOUS)

A. DTO Reference

1. P20.27 - LM Evaluation Rendezvous
2. S20.32 - LM Crew Rendezvous Evaluation
3. P20.33 - CSM Single Crewman Rendezvous Capability.....

B. Test Details

No Special test procedures

C. Procedural Reference

FCSD Rendezvous Procedures Document

D. Data Requirements

1. LM HBR during any MSFN coverage (M) [P20.33] [P20.27]
2. CSM LBR (M) [P20.33]
3. MSFN best estimate of trajectory for Rendezvous period  
(M) [P20.33] [P20.27]\_\_\_\_\_

E. Crew Logging/Recording Requirements

1. Comments on procedures and timelines by CSM and LM crewmen (M)  
[P20.33] [P20.27]
2. Comments on PGNCs and RR performance (M) [P20.27]
3. Comments on charts for backup solution (M) [P20.33]
4. Comments on SXT navigation (M) [P20.33]
5. Comments on usefulness of CSM rendezvous beacon light (M) [P20.27]
6. Estimated differences in time between one and two man operation  
to: (M) [S20.32]
  - a. Prepare for APS burn
  - b. Perform APS burn
  - c. Rendezvous and dock

POST RENDEZVOUS INSPECTION (GET 48: 40: 00)

A. DTO Reference

1. S7.29 - Post Rendezvous Exhaust Impingement Photography
2. M17.17 - Post Rendezvous Exhaust Inspection
3. M17.18 - Post Rendezvous Photography

B. Test Details

1. LM and CSM at station keeping distance prior to docking.
2. LM crewman photographs the CSM surfaces for exhaust impingement. [S7.29]
3. LM rotates slowly while CSM crewman photographs the LM
4. CSM crewman photographs the LM surfaces for SM and LM exhaust impingement using Hasselblad 80 mm lens, S0121 film. [M17.17]
5. CSM takes photographs of LM at  $\approx 20$  feet. [M17.18]

C. Procedural Reference

N/A

D. Data Requirements

1. Photos of CSM surfaces; one is (M); two are (HD) [S7.29]
2. Photos of LM surfaces; one is (M); two are (HD) [M17.17]; HD[M17.18]

E. Crew Logging/Recording Requirements

Comments by CSM & LM crewmen on observable effects of RCS exhaust impingement from CSM and from LM (HD) [M17.17]

RR CORONA TEST

(GET 98: 48: 00)

A. DTO Reference

P16.19 - Rendezvous Radar/RCS Plume Impingement/Corona Effect

B. Test Details

1. Test performed prior to docking and after rendezvous
2. Rendezvous Radar is operating in MAN or LGC mode
3. RR Antenna is oriented as follows:
  - Trunnion = 0 degrees ( $\pm$  1 degree)
  - Shaft = -60 degrees ( $\pm$  1 degree)
4. Crewman (using TTCA) translates -X  $\approx$  one second with jets IU and 4U.
5. Crew monitors RR transmitter RF on signal strength meter during firing

C. Procedural Reference

None

D. Data Requirements

LM HBR (M)

E. Crew Logging/Recording Requirements

RR RF power output changes will be recorded from the SIGNAL STRENGTH meter before, during, and after RCS engine firing. (M)

## LM PGNCS ATTITUDE CONTROL

### A. DTO Reference

Pl1.7 - PGNCS Attitude Control

### B. Test Details

1. LM configuration is undocked, ascent stage only.
2. Tests may be conducted as a part of normal mission activities as follows:
  - a. Proportional rate command attitude hold in all axes (+ and -).  
(GET 98: 47: 00)
  - b. Minimum impulse attitude control. (Implemented throughout Rendezvous)
  - c. 2°/sec auto attitude maneuver. (GET 97: 52: 00)
  - d. 0.5°/sec auto attitude maneuver. (GET 99: 05: 00)
  - e. Minimum deadband auto attitude hold. (GET 97: 05: 00) >2/3 Main asc.
  - f. Maximum deadband auto attitude hold. (GET 98: 55: 00) eng.prplnt.load

Note - Tests B.2.e and B.2.f: Rates > 1°/sec in one axis (M), in all axes (HD), prior to start of hold. Hold will be maintained through one zero-error crossing cycle ( $\pm$ ) in each axis.  
(0.5 minutes minimum deadband, 5.0 minutes maximum deadband)

### C. Procedural Reference

1. PGNCS Attitude Hold/Rate Cmd., Section 4.5.1.3 (Tests B.2.a., B.2.c., B.2.f.)
2. PGNCS Minimum Impulse, Section 4.5.1.4 (Test B.2.b.)
3. PGNCS Automatic, Section 4.5.1.2 (Tests B.2.c., B.2.d.)
4. DAP Data Load Routine, Section 4.6.1.8  
AOH LMA 790-3-LM3

### D. Data Requirements

1. LM HBR (M)
2. Continuous TM coverage for a minimum of 0.5 min (Test B.2.e.) and 5 min (Test B.2.f.) (M)

### E. Crew Logging/Recording Requirements

1. Initial body rates prior to attitude hold (Tests B.2.e., B.2.f.)  
(M unless available on HBR TM)
2. Time attitude hold begins (M unless available on TM), and times of attitude error zero crossings in each axis (M unless available on HBR TM) (Tests B.2.e., B.2.f.)



3. Describe success of proportional rate command and minimum impulse control modes (M) (Tests B.2.a, B.2.b.)
4. Inertial attitudes prior to, and at the conclusion of, automatic maneuvers (M unless available on HBR TM) (Tests B.2.c., B.2.d.)
5. Value of the selected maneuver rate entered into the DSKY (M unless available on HBR TM) (Tests B.2.c., B.2.d.)
6. Any information regarding unusual torques or venting (HD)

LM ACTIVE DOCKING (GET 99: 13: 00)

A. DTO Reference

P20.28 LM Active Docking

B. Test Details

1. Active LM ascent stage will dock with the CSM during daylight.
2. Take photographs from the CM from the time of LM approach until initial probe and drogue capture latching occurs. Sequence camera mounted in CM left hand rendezvous window.

C. Procedural Reference

1. LM Active Docking, Section 4.11.2, AOH LMA 790-3-LM3
2. LM Active Docking with CSM, Section 4.5.1.7, AOH SM2A-3-SC104-(2)

D. Data Requirements

1. CSM LBR (M)
2. LM HBR (M)
3. CSM HBR (HD)
4. LM DFI (HD)
5. Photography using sequence camera (M)

E. Crew Logging/Recording Requirements

1. Comments on LM handling characteristics when docking (M)
2. Comments on the adequacy of visual cues on the CSM as used by the LM crew for a docking alignment target (M)
3. The included angle between the CM and LM Z-X planes, measured about the CM roll axis after docking (M)
4. Record GET when: (M)
  - a. Preparation for LM active docking was initiated.
  - b. LM active docking was completed.

LM JETTISON (GET 10: 30: 00)

A. DTO Reference

P20.29 LM Jettison

B. Test Details

1. LM jettison will occur in daylight.
2. The sequence camera will be used to photograph the top of the ascent stage and tunnel area during and after separation. Camera in left rendezvous window of CSM.

C. Procedural Reference

Final CSM Separation from LM, Section 4.5.1.9, AOH SM2A-03-SC104-(2)

D. Data Requirements

1. LM HBR Data (HD)
2. CSM HBR Data for approximately 10 seconds during separation (M)
3. Photography of LM (HD)

E. Crew Logging/Recording Requirements

Crewman comments on adequacy of separation maneuvers of LM and CSM and condition of docking ring (M)

APS BURN TO DEPLETION (GET:102:00:00)

A. DTO Reference

1. P11.10 - Data for LM IMU Performance
2. P11.14 - PGNC S Controlled APS Burns
3. S13.10 - APS Burn to Depletion
4. M13.11 - Long Duration APS Burn
5. M17.17 - Long Duration APS Burn
6. M17.18 - LM Structural Integrity during APS Burn

B. Test Details

1. Crew will set LM up for burn and return to CSM prior to LM jettison from CSM.
2. Burn is performed under PGNC S control [P11.14] (Control via MSFN to DCA command)
3. Burn is to propellant depletion [P13.10] (Propellant tanks will be nearly full at ignition and less than 1/4 full at ECO [P11.14].)
4. Burn Parameters
  - a. Ullage: 3 sec
  - b. APS Burn Duration: 360 sec
  - c.  $\Delta V$ : 5658.5 fps
  - d. Guidance: PGNC S - Ext  $\Delta V$

C. Procedural Reference

APS Burn to Depletion, Section 4.10.6  
AOH LMA 790-3-LM3

D. Data Requirements

1. LM HBR (M) [P11.14] [M13.11] [M17.17]
2. LM DFI (M) [S13.10] [M13.11] [M17.17] [M17.18]
3. MSFN T/M coverage is mandatory 60 seconds prior to and during the APS burn, highly desirable for 60 seconds after burn. [P11.14]
4. MSFN best estimate of trajectory (M) [P11.14] [P11.10] [M17.17]

E. Crew Logging/Recording Requirements

N/A

## S065 PHOTOGRAPHY

### A. DTO Reference

Experiment S065

### B. Test Details

1. Mount S065 camera hardware in the side hatch window for photography
2. Spacecraft will be maneuvered to attitude supplied by MSFN.

Optical axes of cameras will be aligned to within five degrees of the local vertical when exposures are being made. For single site photography, spacecraft to be position so that the optical axes is concentric with the local vertical midway through the exposure sequence. For multi-site continuous photography, orbital rate to be established prior to starting the exposure sequence.

3. MSFN to provide crew (via update pad) site photography requirements:
  - a. Time to begin e.g. first exposure
  - b. Exposure interval
  - c. Number of exposures...

### C. Procedural Reference

NONE

### D. Data Requirements

1. Photography of sites as described on the following pages (M)
2. MSFN best estimate of trajectory during periods of exposures (M)

### E. Crew Logging/Recording Requirements

Get, exposure interval, and number of exposures if different from pad update (M)

APOLLO MISSION D PHOTOGRAPHIC SITES

<u>Site</u>	<u>No. of Exposures</u>	<u>Latitude</u>	<u>Longitude</u>	<u>Earth Resources Test Site</u>	<u>Priority</u>
<u>NORTH AMERICA</u>					
Northern Baja California	(See Note 1)	31°00'N	115°30'W	---	M
Colorado River mouth	(See Note 1)	31°50'N	114°50'W	---	M
Twin Buttes, Arizona	(See Note 1)	31°53'N	111°10'W	115	M
Willcox Lake	(See Note 1)	32°10'N	109°52'W	31	M
Deming, New Mexico	(See Note 1)	32°20'N	107°40'W	---	M
El Paso, Texas	(See Note 1)	31°45'N	106°30'W	---	M
Guadalupe Mountains	(See Note 1)	31°55'N	105°00'W	---	HD
Houston-Galveston area	6 (See Note 2)	29°40'N	95°10'W	175	M
Dallas-Fort Worth area	6	32°43'N	97°14'W	---	HD
Salton Sea, Borrego Springs, California	6	33°20'N	115°50'W	27	M
Weslaco, Texas	6	26°15'N	98°25'W	32	M
Corpus Christi, Texas	6	28°10'N	97°50'W	---	HD
Presidio, Texas	6	29°40'N	104°15'W	16	M
Mississippi River delta	6	29°10'N	89°20'W	128	M
Cape Kennedy, Florida	6	28°30'N	80°50'W	---	M
Valley of Toluca, Mexico	6 (See Note 3)	19°18'N	99°40'W	---	HD
Chapingo, Mexico	6 (See Note 3)	19°30'N	98°52'W	---	M
Veracruz, Mexico	6 (See Note 3)	19°12'N	96°12'W	---	HD
Mexicali	6	32°38'N	115°30'W	---	HD
Bajo Rio Bravo (Matamoras)	6	25°52'N	97°31'W	---	HD
Yucatan Coast	6	22°00'N	89°00'W	172	HD
<u>ATLANTIC OCEAN</u>					
Tongue of the Ocean	6	23°40'N	77°00'W	---	HD
Barbados	6	13°10'N	59°34'W	---	M
Bermuda	6	32°18'N	64°45'W	86	M
Puerto Rico	6	18°15'N	66°30'W	92	M

AFRICA

Ethiopia	6	10°00'N	40°00'E	---	HD
Somali Republic	6	05°00'N	47°00'E	---	HD
Kenya	6	00°00'N	38°00'E	---	HD
Tansania	6	5°00'S	35°00'E	---	HD
Uganda	6	01°00'N	33°00'E	---	HD
Mauritania	6	17°00'N	15°37'W	---	HD

(See Note 4)

Mali	6	12°39'N	08°09'W	---	HD
------	---	---------	---------	-----	----

(See Note 4)

Ghana, Togo, Dohomey	6	06°10'N	01°50'E	---	HD
----------------------	---	---------	---------	-----	----

(See Note 4)

Congo Republic	6	11°24'S	27°42'E	---	HD
----------------	---	---------	---------	-----	----

(See Note 4)

Congo Republic	6	04°19'S	17°02'E	---	HD
----------------	---	---------	---------	-----	----

(See Note 4)

Malawi (Blantyre)	6	15°45'S	34°58'E	---	HD
-------------------	---	---------	---------	-----	----

(See Note 4)

Mozambique	6	17°22'S	37°57'E	---	HD
------------	---	---------	---------	-----	----

(See Note 4)

Malagasay Republic	6	20°52'S	44°38'E	---	HD
--------------------	---	---------	---------	-----	----

(See Note 4)

PACIFIC OCEAN

Hawaiian Islands	6	19°30'N	155°30'W	---	HD
------------------	---	---------	----------	-----	----

New Guinea	6	06°00'S	142°00'E	---	HD
------------	---	---------	----------	-----	----

Australia

Alice Springs	6	22°30'S	134°00'E	---	M
---------------	---	---------	----------	-----	---

Lake Eyre	6	28°30'S	137°20'E	---	M
-----------	---	---------	----------	-----	---

SOUTH AMERICABrazil

Campinas	6	22°54'S	47°06'W	---	M
----------	---	---------	---------	-----	---

Quadrilatero Ferrifero	6	19°49'S	43°22'W	---	M
------------------------	---	---------	---------	-----	---

		20°30'S	43°50'W	---	M
--	--	---------	---------	-----	---

Rio De Janiero	6	22°40'S	43°00'W	---	M
----------------	---	---------	---------	-----	---

	6	23°00'S	43°18'W	---	M
--	---	---------	---------	-----	---

Cape Frio	6	22°30'S	40°30'W	---	M
-----------	---	---------	---------	-----	---

		23°30'S	42°00'W		
--	--	---------	---------	--	--

- Note 1 - Sites from Baja, California to the Guadalupe Mountains should be covered with overlapping views, for stereo viewing, along the Apollo 6 flight path. If individual sites only are photographed, obtain six exposures per site. If taken continuously, a total of 18 exposures should be taken.
- Note 2 - If photographs of the Houston-Galveston area (Test Site 175) cannot be obtained, photographs of the Dallas-Fort Worth area are second choice.
- Note 3 - Continuous overlapping views from Cabo Corrientes to Veracruz, Mexico, centered on Valley of Toluca, are preferred. This coverage should include the Chapingo site. Fifteen exposures will cover this area coast-to-coast.
- Note 4 - Sites from Mauritania to Malagasy Republic should be covered on one pass with overlapping views along the Apollo 6 flight path. If individual sites only are photographed, obtain six exposures per site.



ORBITAL NAVIGATION/LANDMARK TRACKING (GET 142:30:00)

A. DTO Reference

1. 31.26 - Orbital Navigation/Landmark Tracking

B. Test Details

1. Perform P 22 (Landmark Tracking Program)
2. Track landmarks for three revolutions
3. The following pertain to each tracking revolution and sighting
  - a. Track minimum of three landmarks per revolution
  - b. Select landmark locations to a maximum of 45° off orbital track
  - c. Use the Yaw/Roll technique
  - d. IMU to be aligned during dark period in each revolution preceding sightings.
  - e. Minimum of 4 marks per sighting
  - f. Minimum of 15 seconds between two successive marks

C. Procedural Reference

Orbital Navigation (P22) Section 4.12.2,  
AOH SM2A-03-SC104 - (2)

D. Data Requirements

1. CSM LBR data (M-required once during each landmark tracking) (HD)
2. MSFN best estimate of trajectory during sightings (M)

E. Crew Logging/Recording Requirements

1. Time required for each sighting (from initial recognition through final marking) (M)
2. Manual altitude control mode (M)
3. Adequacy of recognition maps (M)
4. Comments on coordinating optics and spacecraft motion (M)

CREW MONITORING

Note: The following reoccurring/monitoring tasks are performed by the crew on a continuing basis and include data collection via telemetry.

CREW LOGGING/RECORDING REQUIREMENTS	DTO REFERENCE
<p>1. LM LBR (M)</p> <p>2. LM DFI (M) (Data required 2 seconds every 12 hours from LM activation through the second DPS burn as a minimum)</p> <p>No Crew recording required</p>	<p>M13.12 Supercritical Helium Measurements</p>
<p>1. GET of the following as they occur: (M)</p> <p>a. Cabin warning light on</p> <p>b. ECS caution light on</p> <p>c. CO<sub>2</sub> component caution light on</p> <p>2. Comments and GET of the following as they occur: (HD)</p> <p>a. Initial and final positions of the suit and cabin temperature control at each change</p> <p>b. Suit configuration when changed</p> <p>c. Noxious odors, if any</p> <p>d. Condensation in cabin, if any, and location</p> <p>e. Debris (lint) on intake screen, if any</p> <p>f. Estimation of amount of water consumed</p>	<p>M14 - ECS Event Times and Data Collection (LM only)</p>
<p>Comment on the existence, if any, of conducted or radiated EMI as related to crew safety or to CSM, LM, or PLSS performance.</p>	<p>S20.121 - CSM/LM Electro-magnetic Compatibility</p>
<p>Comments on adequacy of MSFN support during the mission (M)</p>	<p>S20.31 - Support Facilities Performance</p>

CREW LOGGING/RECORDING REQUIREMENTS	DTO REFERENCE
<ol style="list-style-type: none"> <li>1. Comments on ability to distinguish individual RCS thruster firings (HD)</li> <li>2. Data on undesirable noises (if heard) (HD) <ol style="list-style-type: none"> <li>a. GET</li> <li>b. Origin of noise</li> <li>c. Description of noise</li> </ol> </li> <li>3. Comments on stowing and unstowing equipment on the aft bulkhead (M), photographic coverage is HD</li> <li>4. Comments on replacing a LiOH cartridge (M), photographic coverage is HD</li> </ol>	<p>S20.32 - Crew Activities and Evaluations (CSM only)</p>
<ol style="list-style-type: none"> <li>1. Capability of one man to operate the LM (M)</li> <li>2. Adequacy of the LM waste management system (M)</li> <li>3. Comments on ability to distinguish individual RCS thruster firings (HD)</li> <li>4. Data on undesirable noises (if heard) (HD) <ol style="list-style-type: none"> <li>a. GET</li> <li>b. Origin of noise</li> <li>c. Description of noise</li> </ol> </li> <li>5. Comments on attaching crew restraint systems (M), photographic coverage is HD</li> </ol>	<p>S20.32 - Crew Activities and Evaluations (LM only)</p>
<p>During normal center couch folding and unfolding, photograph the crewman performing the activity (HD). Record comments on crew capability to perform couch folding and unfolding activities (M)....</p>	<p>S20.32 - Unfolding Couch; Folding Couch</p>

SECTION 5 - COMMUNICATIONS PLAN

SECTION 5

## SECTION 5

### COMMUNICATIONS PLAN

A plan for communications modes of operations during Mission D is described in this section. These modes are defined for each of the following phases of mission activities: Launch, Insertion to LM Activation, LM Activation and Checkout, Extravehicular Activity, Rendezvous, LM Jettison, and Post LM Jettison. Variations to this plan are required for satisfaction of Detailed Test Objectives and are described along with other DTO's, in order of implementation, in Section 4 of this document.

Lunar Module Developmental Flight Instrumentation (DFI) is available only on LM 3, and is used for C-Band ranging, transmitting real time data from the PCMTEA, and transmitting data from special instrumentation. A DFI duty cycle is presented on pages 5-7 through 5-12.

A table listing MSFN station capabilities is presented on page 5-13.

Throughout the mission the CSM telecommunications system will be configured for optimum ground control via RTC. The DSE will record continuously at low speed (for LBR) unless HBR is selected by the crew, or ground RTCs a data dump. During all but the EVA and Rendezvous portions of combined LM/CSM operations, the LM will transmit LBR PCM data via VHF B to the CSM for DSE recording except when LM HBR PCM is required by MSFN.

The RTC by MSFN for a typical station pass would include:

a. If there is a DSE data dump:

STA AOS: DSE - Rewind  
PCM - HBR  
S-Band Tape Mode (FM on)  
DSE - Playback mode

At end of DSE:  
Rewind DSE - Forward

At end of DSE:  
Dump DSE - Rewind  
S-Band tape off (FM off)  
DSE - Record

STA LOS: PCM - LBR  
DSE - FORWARD

b. If there is no DSE data dump:

STA LOS: DSE - STOP  
PCM - HBR

STA LOS: PCM - LBR  
DSE - Forward

There is no television scheduled for the CM.

A "CSM Communications Basic" configuration is established for the mission and, with exceptions noted under specific mission phases, will be maintained as follows:

Panel 4

TELCOM GRP 1 - AC1  
TELCOM GRP 2 - AC2

Panels 9, 10, 6:

MODE (3) - INTERCOM/PTT  
S BD (3) - T/R (S-Bd vol muted)  
SUIT PWR (3) - ON (up)  
AUDIO CONT (3) - NORM  
PWR (3) - AUDIO/TONE  
VHF AM (3) - T/R  
INTERCOM (3) - T/R  
PAD COMM (3) - OFF

Panel 3:

S BD XPNDR - PRIM  
S BD PWR AMPL PRIM - PRIM  
S BD PWR AMPL HI - HI  
S BD MODE VOICE - VOICE

Panel 3

S BD MODE PCM - PCM  
S BD MODE RNG - RNG  
UP TLM DATA - DATA  
UP TLM CMD - NORM  
S BD ANT OMNI - B  
S BD ANT OMNI - OMNI  
VHF AM A - SIMPLEX  
VHF AM B - OFF (ctr)  
VHF AM RCV ONLY - OFF (ctr)  
VHF BCN - OFF  
TAPE RCDR PCM - PCM/ANLG  
TAPE RCDR RCD - RCD  
TAPE RCDR FWD - FWD  
SCE PWR - NORM  
PMP PWR - NORM  
PCM BIT RATE - LOW  
VHF ANT - SM LEFT

Panel 100:

RNDZ XPNDR - OFF

Launch: The launch phase covers the period from lift off to insertion.

1. The CM communications configuration employed during this period will vary from the CSM Communications Basic as follows:

Panel 3

VHF AM B-Duplex

Panel 6

Audio: S-BAND VOL - Increase  
VHF AM VOL - Increase

2. LM DFI will be commanded on one minute prior to liftoff and deactivated automatically four minutes after liftoff. (See DFI schedule on page 5-7.)
3. During all sleep periods, the communications power-down configuration will be CSM Communications Basic with exceptions as follows:

Panels 9, 10, 6

S BAND VOL - Full decrease

Panel 3

VHF AM A - Duplex  
VHF AM RCV ONLY - A

Insertion to LM Activation: The communications configuration for this period will be the CSM Communications Basic Configuration described above.

LM Activation and Checkout: The initial, inflight activation and checkout of LM communications systems performed during this period offer the first opportunity to implement DTOs pertaining to S-Band and VHF operational modes. These DTO activities are described on pages 4-30, 4-31, 4-34 and 4-36.

1. CSM communications will be configured to the CSM Communications Basic except:

Panel 3

VHF AM RCV ONLY - B DATA

2. LM communications during this period will be as follows:
  - a. LM PCM transmission is enabled just after EPS Activation to allow maximum MSFN coverage.
  - b. LM C-Band tracking and DFI will be activated upon MSFN command to the crew when required. (See DFI Schedule on pages 5-7 through 5-12.)
  - c. A "LM Communications Basic" configuration will be established after VHF A Checkout and, with exceptions required for DTO implementation and noted during other mission phases described below, be maintained as follows:

S-BAND MODULATE ---PM	VHF B XMTR - DATA
S-BAND XMTR/RCVR - PRIM	VHF B RCVR - OFF
S-BAND PWR AMPL - PRIM	AUDIO (BOTH): S-BAND- T/R
VOICE - VOICE	ICS - T/R
PCM - PCM	RELAY - OFF
RANGE - RANGE	AUDIO CONT - NORM
BIOMED - LEFT OR RIGHT	VOX - ICS
TLM - LO	VHF A - T/R
VHF A XMTR - ON	VHF B - OFF
VHF A RCVR - ON	CB(11) Comm: CDR Audio - Close
	CB(16) Comm: SE Audio - Close

- d. Biomed will be "Right" (LMP) for the first half of Activation Day and "Left" (CDR) for the second half.

Extravehicular Vehicular Activity (EVA): The normal communications mode for EVA uses the CSM as a relay to MSFN. The backup EVA communications mode uses LM relay to MSFN. The EVA communications configuration will be established during the LM PLSS COMM CHECK and will be maintained until LM POST EVA SYSTEM CONFIGURATION unless a real-time decision is made to change. Prior to station LOS MSFN will RTC (as desired) Down Voice Backup on the CSM to permit DSE recording of LM voice. After station AOS MSFN will RTC back to relay mode for MSFN comm. One communications DTO implemented in conjunction with the EVA period is described on page 4-49.

1. CSM One-Way Down Relay (EMU/LM/CSM/MSFN) Mode (normal):
  - a. The CSM will be configured to the CSM Communications Basic with the exceptions as follow:

VHF AM A - DUPLEX A	S-BD NORMAL MODE - RELAY
VHF AM RCV ONLY - A	CMP AUDIO PWR - OFF

- b. The LM will be configured to the LM Communications Basic with exception as follows: (PLSS Primary Mode)

VHF RCVR B - ON	VOX (CDR) - ICS/XMTR
VHF B XMTR - VOICE	BIOMED - LEFT
AUDIO: VHF B (CDR) - RCV	VHF ANT - 1/PLSS TEST
CB (16) Comm: SE AUDIO - OPEN	TLM - HI

2. LM one-way down relay (EMU/LM/CSM/MSFN) mode (backup):

- a. The CSM will be configured to the CSM Communications Basic with exceptions as follow:

VHF AM A - DUPLEX A  
VHF AM RCV ONLY - A

- b. The LM will be configured to the LM Communications Basic with exceptions as follow:

AUDIO: VHF A (CDR) RCV (T/R only while CDR is transmitting PTT)	
VHF B (CDR) - RCV	RELAY (LMP) - ON
VOX - (BOTH) ICS/XMTR	VHF ANT - 1/PLSS TEST
VHF A (LMP) - OFF	BIOMED - LEFT
VHF B (RCV) - ON	VHF B XMTR - VOICE

3. LM DFI and C-Band tracking will be activated upon MSFN command to the crew when required. (See DFI Schedule on pages 5-7 through 5-12.)

Rendezvous: Rendezvous communications will be established to permit VHF B backup voice between the LM and CSM while undocked. (This configuration will not allow LM transmission of data or voice to the CSM for DSE recording.) The Rendezvous communications configuration will be established during LM PREP FOR UNDOCKING and will be maintained until LM CLOSEOUT unless a real-time decision is made to change. One communications DTO implemented in conjunction with the Rendezvous period is described on page 4-66.

1. The CSM will be configured to the CSM Communications Basic with exceptions as follow:

VHF AM A - DUPLEX  
VHF AM RCV ONLY - A

2. The LM will be configured to the LM Communications Basic with exceptions as follow:

AUDIO: VHF B (BOTH) - RCV	TLM - HI
VHF B RCVR - ON	VHF B XMTR - VOICE

3. LM DFI and C-Band tracking will be activated upon MSFN command to the crew when required. (See DFI Schedule on pages 5-7 through 5-12.)

4. LM Biomed will be "right" (LMP) for the first half of Rendezvous Day and "Left" (CDR) for the second half.



LM Jettison: Prior to pre-jettison closeout, the LM is configured to transmit data during the unmanned jettison and subsequent long duration APS burn to depletion. Subsequent to jettison, all LM activities are commanded by RTC via DCA uplink from MSFN.

1. The CSM will be configured to the CSM Communications Basic.
2. The LM will be configured to the LM Communications Basic.
3. LM DFI and C-Band tracking data will be transmitted to MSFN when Station coverage is available. (See DFI Schedule on pages 5-7 through 5-12.)

Post LM Jettison: The CSM will normally be configured to the CSM Communications Basic from LM Jettison to Splashdown.

### LM DFI SCHEDULE

The developmental Flight Instrumentation (DFI) is composed of three main components:

- 1) C-Band for tracking.
- 2) DFI VHF B transmitter for real time PCM data.
- 3) DFI VHF A, D, E and F transmitters for developmental flight data with no real time monitoring.

The procedure for obtaining the data through DFI VHF A, D, E and F transmitters requires that the C-Band and DFI VHF B transmitter also be on.

C-Band can be on separately as can DFI VHF B.

Table I shows the timeline for each DFI component. Certain MSFN stations (single and modified single) are not equipped to receive real time S-Band telemetry from both vehicles concurrently. LM DFI VHF B is used in lieu of S-Band so that data from both vehicles may be obtained and over all stations with DFI VHF B capability during the Rendezvous period.

A CSM DSE "Record" Schedule is included to indicate DSE recording of LM LRF PCM.

TABLE 1 - DFI (INSTRUMENTATION, VHF B, C-BAND) SCHEDULE

GET (HR:MIN)	DFI VHF A, D, E, F	DFI VHF B	C-BAND	RECORD (CSM DSE)	REMARKS
DAY 1					
-00:01	ON				LAUNCH
00:04	OFF				
DAY 3					
42:36	ON	ON	ON		EPS ACTIVATION AND CHECKOUT
42:55	OFF		OFF	ON	POWER UP
43:17				OFF	
43:30	ON		ON		GLYCOL PUMP CHECK
43:36	OFF		OFF		
43:38				ON	
44:03				OFF	
44:32				ON	
44:52				OFF	
45:00	ON		ON		LANDING GEAR DEPLOY
45:05	OFF		OFF		
45:14				ON	
45:40				OFF	

TABLE 1 - DFI (INSTRUMENTATION, VHF B, C-BAND) SCHEDULE

GET (HK:MIN)	DFI VHF A, D, E, F	DFI VHF B	C-BAND	RECORD (CSM DSE)	REMARKS
46:09		ON		ON	
46:23				OFF	
46:50				ON	
47:15				OFF	
47:45				ON	
47:58				OFF	
48:15	ON		ON		LR SELF TEST
48:20	OFF		OFF		
48:26				ON	ACS INITIALIZATION & DPS PRESS.
48:54				OFF	
49:34	ON		ON		DOCKED DPS & LR SPUR TEST
49:50	OFF				
50:02				ON	
50:22	ON			OFF	SUBLIMATOR DRYOUT
50:31					

DAY 3

TABLE 1 - DFI (INSTRUMENTATION, VHF B, C-BAND) SCHEDULE

GET (HR:MIN)	DFI VHF A, D, E, F	DFI VHF B	C-BAND	RECORD (CSM DSE)	REMARKS	
50:55	OFF	OFF	OFF		POWER DOWN	
69:41		ON				
70:06				ON		
70:24				OFF		
70:48				ON		
71:15				OFF		
71:40				ON		
71:53				OFF		
72:21				ON		
72:49				OFF		
73:11				ON		VOICE RECORD ONLY
73:17				OFF		
73:22				ON		VOICE RECORD ONLY
73:25				OFF		
73:55				ON		VOICE RECORD ONLY

DAY 3

DAY 4

TABLE 1 - DFI (INSTRUMENTATION, VHF B, C-BAND) SCHEDULE

GET (HR:MIN)	DFI VHF A, D, E, F	DFI VHF B	C-BAND	RECORD (CSM DSE)	REMARKS
74:06		ON		OFF	
74:15		↓		ON	VOICE RECORD ONLY
74:25				OFF	
74:35				ON	VOICE RECORD ONLY
74:39				OFF	
74:46				ON	VOICE RECORD ONLY
74:50				OFF	
75:21				ON	VOICE RECORD ONLY
75:26				OFF	
75:34				ON	
75:58				OFF	
76:06				ON	
76:15				OFF	
76:18				ON	
76:25				OFF	

DAY 4

TABLE 1 - DFI (INSTRUMENTATION, VHF B, C-BAND) SCHEDULE

GET (HR:MIN)	DFI VHF A, D, E, F	DFI VHF B	C-BAND	RECORD (CSM DSE)	REMARKS
DAY 4					
76:47	ON	ON	ON		SUBLIMATOR DRYOUT
77:08	↓	↓	↓	ON	
77:20	OFF	OFF	OFF	OFF	POWER DOWN
DAY 5					
89:27				ON	
89:42				OFF	
89:52				ON	
90:40				OFF	
90:45				ON	
91:07		ON		OFF	
91:27		↓		ON	
91:54		↓		OFF	
92:41		↓	ON		CSM/LM UNDOCKING
93:45	ON	↓	↓		DPS PHASING BURN
93:52	OFF	↓	↓		
95:39	ON	↓	↓		DPS INSERTION BURN
95:45	OFF	↓	↓		

TABLE 1 - DFI (INSTRUMENTATION, VHF B, C-BAND) SCHEDULE

GET (HR:MIN)	DFI VHF A, D, E, F	DFI VHF B	C-BAND	RECORD (CSM DSE)	REMARKS
97:04	ON	ON	ON		APS CDE BURN
97:09	OFF				
98:45	ON				RR CORONA TEST THROUGH DOCKING
99:20	OFF				
100:40	ON				LM CLOSEOUT FOR APS BURN TO DEPLETION

DAY 5



PLANNED MSFN STATION CAPABILITIES FOR MISSION D

TABLE 3

STATION	UNIFIED S-BAND (USB)				DFI (LM)				UHF A&B VOICE CMD	RECORD	TV RECORD					
	*STATION TYPE		MOD	SINGLE	CMD	TLM	TRK	VOICE				BIO MED	C-BAND TRK	VHF B PCM	VHF A D, E&F	
	DUAL	SINGLE														
MERRITT ISLAND (MIL)	30'			X	X	X	X	X	X	X	X	X	X	X	X	
GRAND BAHAMA (GBM)		30'		X	X	X	X	X	X	X	X	X	X	X	X	X
ANTIGUA (ANG)			30'	X	X	X	X	X	X	X	X	X	X	X	X	X
ASCENSION (ACN)	30'			X	X	X	X	X	X	X	X	X	X	X	X	X
BERMUDA (BDA)		30'		X	X	X	X	X	X	X	X	X	X	X	X	X
CANARY ISLANDS (CYI)			30'	X	X	X	X	X	X	X	X	X	X	X	X	X
CARNARVON (CRO)	30'			X	X	X	X	X	X	X	X	X	X	X	X	X
GUAM (GWM)	30'			X	X	X	X	X	X	X	X	X	X	X	X	X
HAWAII (HAW)	30'			X	X	X	X	X	X	X	X	X	X	X	X	X
GUYMAS (GYM)			30'	X	X	X	X	X	X	X	X	X	X	X	X	X
TEXAS (TEX)			30'	X	X	X	X	X	X	X	X	X	X	X	X	X
GOLDSTONE (GDS)	85'			X	X	X	X	X	X	X	X	X	X	X	X	X
MADRID (MAD)	85'			X	X	X	X	X	X	X	X	X	X	X	X	X
HONEYSUCKLE (HSK)	85'			X	X	X	X	X	X	X	X	X	X	X	X	X
VANGUARD (VAN)	30'			X	X	X	X	X	X	X	X	X	X	X	X	X
REDSTONE (RED)	30'			X	X	X	X	X	X	X	X	X	X	X	X	X
MERCURY (MER)	30'			X	X	X	X	X	X	X	X	X	X	X	X	X
HUNTSVILLE (HTV)			12'	X	X	X	X	X	X	X	X	X	X	X	X	X
ARIA (PAFB)																
PATRICK (PATR)																
PRETORIA (PRE)																
CALIFORNIA (CAL)																
WHITE SANDS (WHS)																
TANANARIVE (TAN)																
CENT. INS. FACILITY (CIF)																
MERRITT ISL-DOD (MLA)					X											
CAPE KENNEDY (CNV)					X											
GRAND BAHAMA-DOD (GBI)																
ANTIGUA-DOD (ANT)																
ASCENSION-DOD (ASC)																

\*Note: Station type definitions:  
 Single - 1 Uplink, 1 Downlink  
 Mod Single - 2 Uplinks, 1 Downlink  
 Dual - 2 Uplinks, 3 Downlinks

Ref: Flight Operations Plan, Mission D, 23 Aug. 68.  
 Memorandum - MSFN Capabilities for "D" and  
 subsequent missions, 18 June 68.

SECTION 6 - CONSUMABLES ANALYSIS