

APOLLO NEWS REFERENCE

From the check valve, the conditioned oxygen passes through a sublimator to the cooling heat exchanger. The sublimator cools the oxygen under emergency conditions. Heat transfer to the coolant in the heat exchanger reduces gas temperature and causes some condensation of water vapor.

The conditioned oxygen is next routed to two parallel-redundant water separators through the water separator selector valve. One separator, selected by pushing or pulling the water separator selector valve handle, is operated at a time. The separator is driven by the gas flowing through it. Moisture removed from the oxygen is discharged under a dynamic head of pressure sufficient to ensure positive flow from the separator to the WMS. A water drain carries some water from the separators to a surge (collection) tank outside the recirculation system.

The conditioned oxygen from the water separator is mixed with makeup oxygen from the OSCPCS to maintain system pressure. The mixture flows through the regenerative (heating) heat exchanger, where the temperature may be increased, to the suit isolation valves. The suit temperature control valve on the water control module controls the flow of coolant through the regenerative heat exchanger. Setting the valve to the increase hot position increases oxygen temperature; setting it to decrease cold position reduces the temperature.

SUIT LIQUID COOLING ASSEMBLY

The suit liquid cooling assembly assists in removing metabolic heat by circulating cool water through the liquid cooled garment (LCG). A pump maintains the flow of warm water returning from the LCG through the water umbilicals. An accumulator in the system compensates for volumetric changes and leakage. A mixing bypass valve controls the quantity of water that flows through the water-glycol heat exchanger. This bypassed (warm) water is mixed with the cool water downstream of

the heat exchanger, flows through the water umbilicals back to the LCG.

OXYGEN SUPPLY AND CABIN PRESSURE CONTROL SECTION

The ECS descent stage oxygen supply hardware consists of the following: a descent oxygen tank, high-pressure fill coupling, high-pressure oxygen control assembly, an interstage flex line, and a descent stage disconnect. The descent tank pressure transducer, part of the instrumentation subsystem, generates an output proportionate to tank pressure.

The ascent stage oxygen supply hardware consists of the following: an ascent stage disconnect, interstage flex line, oxygen module, two ascent oxygen tanks, a PLSS hose, PLSS oxygen disconnect, and the cabin pressure switch. Two automatic cabin pressure relief and dump valves, one in each hatch, are provided to protect the cabin from overpressurization. Two ascent stage tank pressure transducers and a selected oxygen supply transducer, part of the IS, operate in conjunction with the OSCPCS.

The OSCPCS stores gaseous oxygen, replenishes the ARS oxygen, and provides refills for the PLSS oxygen tank. Before staging, oxygen is supplied from the descent stage oxygen tank. After staging, or if the descent tank is depleted, the ascent stage oxygen tanks supply oxygen to the oxygen control module. The high-pressure assembly in the descent stage, and the oxygen control module in the ascent stage, contain the valves and regulators necessary to control oxygen in the OSCPCS. The cabin relief and dump valves vent excess cabin pressure.

A high-pressure regulator reduces descent tank pressure, approximately 2,730 psia, to a level that is compatible with the components of the oxygen control module, approximately 900 psig. A series-redundant overboard relief valve protects the oxygen control module against excessive pressure caused by a defective regulator or by flow through the bypass relief valve. If the pressure on the outlet



EC-9

APOLLO NEWS REFERENCE

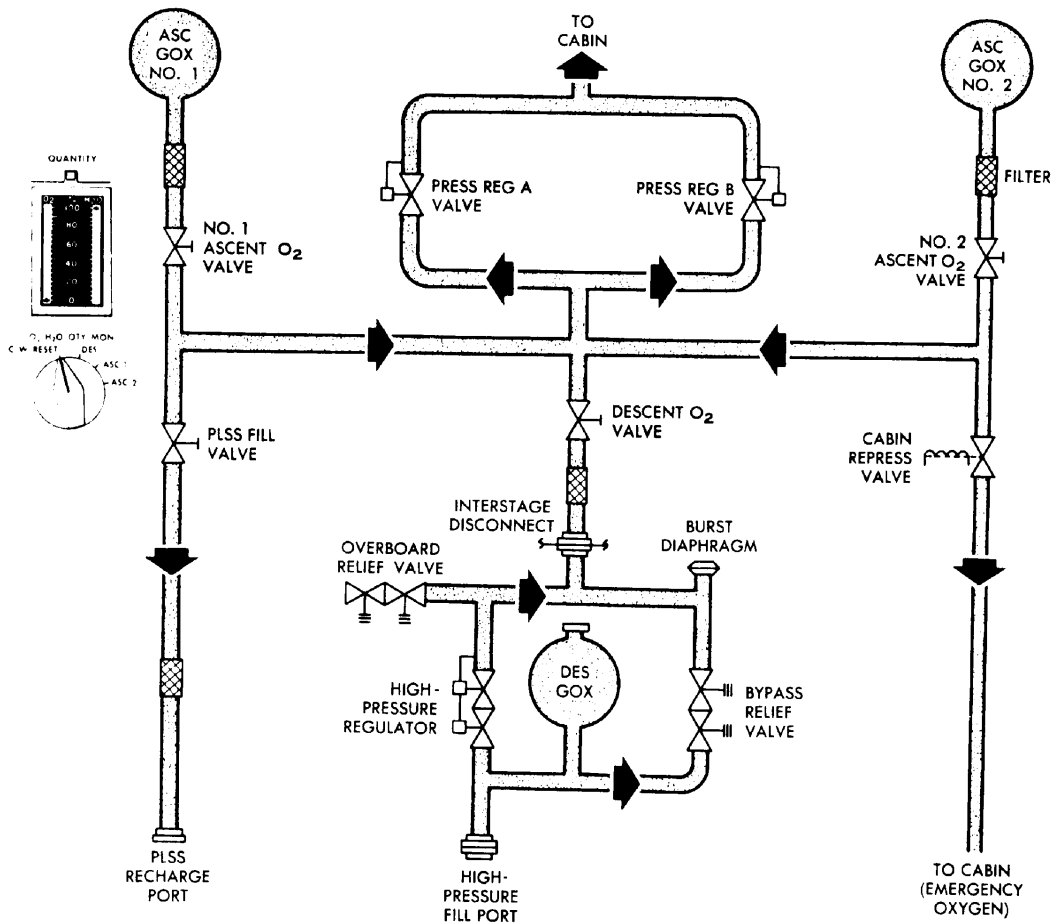

R-35

Oxygen Supply and Cabin Pressure Control Section, Flow Diagram

side of the regulator rises to a dangerous level, the burst diaphragm assembly vents the high-pressure assembly to ambient. A poppet in the burst diaphragm reseats when pressure in the high-pressure assembly is reduced to approximately 1,000 psig. Descent oxygen flow through the interstage disconnect to the oxygen control module is controlled with the descent oxygen shutoff valve. The interstage disconnect acts as a redundant seal to prevent loss of oxygen overboard after staging.

When ascent stage oxygen is required, the ascent oxygen shutoff valves are used to select their respective tank. A mechanical interlock prevents the valves from being opened unless the descent oxygen shutoff valve is closed. The mechanical interlock may be overridden (if the descent oxygen

shutoff valve cannot be closed and the ascent oxygen shutoff valves must be opened) by pressing the interlock override pushbutton on the oxygen control module.

From the oxygen shutoff valves, oxygen is routed to oxygen demand regulators, a PLSS fill valve, and a cabin repressurization and emergency oxygen valve. The PLSS fill valve connects the PLSS oxygen tank through a flexible service hose. A check valve in the PLSS disconnect is opened when the hose is connected. The valve automatically closes when the hose is disconnected. The oxygen demand regulators maintain the pressure of the suit circuit at a level consistent with normal requirements. Both regulators are manually controlled with a four-position handle; both are

EC-10



APOLLO NEWS REFERENCE

ordinarily set to the same position. The CABIN position is selected during normal pressurized-cabin operations, to provide oxygen at 4.8 ± 0.2 psia. Setting the regulators to the egress position maintains suit circuit pressure at 3.8 ± 0.2 psia. The direct O₂ position provides an unregulated flow of oxygen into the suit circuit. The close position shuts off all flow through the regulator. In the cabin and egress positions, the regulator is internally modulated by a reference pressure from the suit circuit. The demand regulators are redundant; either one can fulfill the ARS oxygen requirements.

If both demand regulators are set to the cabin or direct O₂ position and cabin pressure drops to 3.7 to 4.45 psia, the cabin pressure switch energizes the cabin repressurization valve and oxygen flows through the valve into the cabin. If cabin pressure builds up to 4.45 to 5.0 psia, the cabin pressure switch deenergizes the valve solenoid, shutting off the oxygen flow. The valve can maintain cabin pressure at 3.5 psia for at least 2 minutes following a 5.0-inch-diameter puncture of the cabin. It responds to signals from the cabin pressure switch during pressurized-cabin operation and to a suit circuit pressure switch during unpressurized operation. Manual override capabilities are provided.

Both cabin relief and dump valves (one in the forward hatch, the other in the overhead hatch) are manually and pneumatically operated. They prevent excessive cabin pressure and permit deliberate cabin depressurization. The valves automatically relieve cabin pressure when the cabin-to-ambient differential reaches 5.4 to 5.8 psid. When set to the automatic position, the valves can be manually opened with their external handle. The valve in the overhead hatch can dump cabin pressure from 5.0 to 0.08 psia in 180 seconds without cabin inflow. The valve in the forward hatch requires 310 seconds to dump the same amount of cabin pressure because of the flow restriction caused by the bacteria filter. In addition to relieving positive pressure, the valves relieve a negative cabin pressure condition.

To egress from the LM, the oxygen demand regulators are set to the egress position, turning off the cabin fans and closing the suit gas diverter

valve; the cabin gas return valve is set to the egress position; and cabin pressure is dumped by opening the cabin relief and dump valve. A bacteria filter on the cabin side of the cabin relief and dump valve in the forward hatch removes 95% of all bacteria larger than 0.5 micron from the dumped oxygen. When repressurizing the cabin, the cabin relief and dump valve is set to the automatic position, the oxygen demand regulator valves are set to the cabin position, and the cabin gas return valve is set to the automatic position. The cabin warning light goes on when the regulators are set to the cabin position and goes off when cabin pressure reaches the actuation pressure of the cabin pressure switch.

WATER MANAGEMENT SECTION

The WMS stores water for metabolic consumption, evaporative cooling, fire extinguishing, and PLSS water tank refill. It controls the distribution of this stored water and the water reclaimed from the ARS by the water separators. Reclaimed water is used only for evaporative cooling, in the ECS sublimators. Water is stored in a tank in the descent stage and two identical smaller tanks in the upper midsection of the ascent stage. All three tanks are bladder-type vessels, which are pressurized with nitrogen before launch. The controls for the WMS are grouped together on the water control module located to the right rear of the LM Pilot's station.

Water from the descent stage water tank is fed through a manually operated shutoff valve and a check valve to the PLSS water disconnect. Water quantity is determined by a water quantity measuring device, which senses the temperature/pressure ratio of the tank-pressurizing nitrogen, computes the volume of the water, and generates an output analogous to that volume. The output is displayed on the H₂O quantity indicator after the O₂/H₂O quantity monitor selector switch is set to the descent position. If the quantity of water in the tank drops to 16%, the water quantity caution light goes on. When the descent H₂O valve is opened, high-pressure water is available for drinking, food preparation, PLSS fill, and fire extinguishing.



EC-11

"ApolloNewsRef LM F.EC11.PICT" 421 KB 1999-02-04 dpi: 360h x 360v pix: 2644h x 3729v

APOLLO NEWS REFERENCE

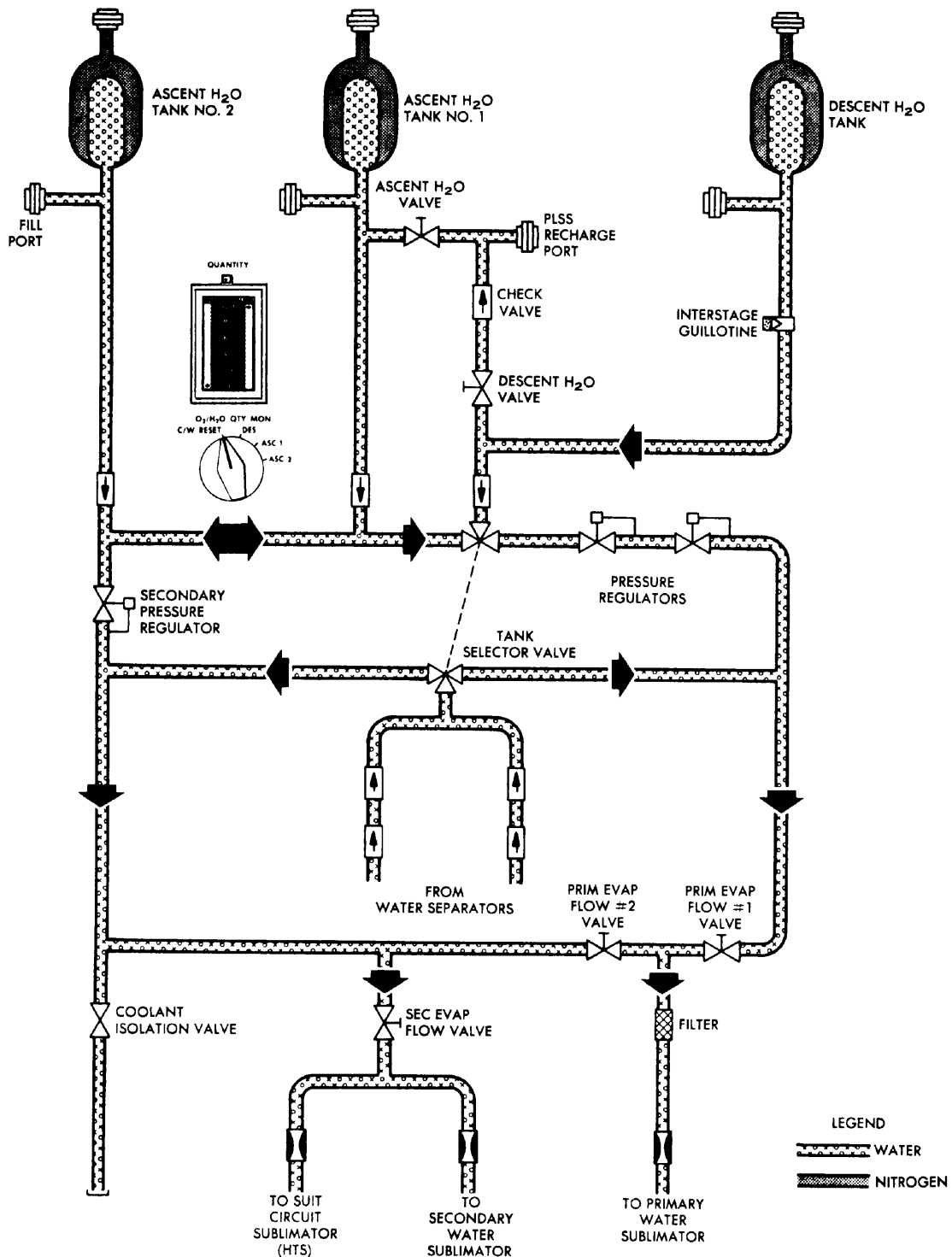

R-36

Water Management Section, Flow Diagram

EC-12



APOLLO NEWS REFERENCE

When the vehicle is staged, the descent interstage water feed line is severed by the interstage umbilical guillotine, and water is supplied from the ascent stage water tanks. Water quantity is monitored on either ascent water tank as required by switching. The water quantity caution light goes on when a less-than-full condition exists in either tank or when the tank water levels are unequal. Water from ascent stage water tank No. 1 is fed to the PLSS water disconnect through the ascent water valve for drinking, food preparation, PLSS fill, and fire extinguishing.

Water from the three water tanks enters the water tank selector valve, which consists of two water diverting spools. Setting the valve to the descent or ascent position determines which tank is on-line.

When using the descent tank, water is supplied to the primary manifold (which consists of the primary pressure regulators and the primary evaporator flow No. 2 valve) by setting the water tank select valve to descent. The water flows through the series primary pressure regulators, which control water discharge pressure, in response to suit circuit gas reference pressure, at 0.5 to 1.0 psi above this gas pressure. With the primary evaporator flow valve opened, the water is routed to the primary sublimator. Discharge water from the water separator is routed through the secondary spool of the selector valve and joins the water from the primary pressure regulators. Setting the selector valve to ASC routes water from the ascent tanks through the primary pressure regulators and, with the primary evaporator flow No. 1 valve opened, to the primary sublimator. Water flow from the water separators is not changed by selection of the ASC position. If the primary pressure regulators fail, an alternative path to the primary sublimator is provided with the primary evaporator flow No. 2 valve opened. Water then flows directly from the ascent water tanks through the secondary pressure regulator and the primary evaporator flow No. 2 valve to the primary sublimator.

Under emergency conditions (failure of the primary HTS loop), water from the ascent tanks is directed through the secondary manifold

(secondary pressure regulator) to the secondary sublimator and the suit circuit sublimator by opening the secondary evaporator flow valve. Discharge water from the water separators is also directed to the sublimator.

HEAT TRANSPORT SECTION

The HTS consists of two closed loops (primary and secondary) through which a water-glycol solution is circulated to cool the suit circuits, cabin atmosphere, and electronic equipment. Coolant is continuously circulated through cold plates and cold rails to remove heat from electronic equipment and batteries. For the purpose of clarity, the primary and secondary coolant loops, and the primary and secondary coolant loop cold plates and rails are discussed separately in the following paragraphs. When necessary, the primary loop is also a heat source for the cabin atmosphere. Heat is removed by absorption and is rejected to space by process of sublimation.

The primary coolant loop is charged with coolant at the fill points and is then sealed. The glycol pumps force the coolant through the loop. The glycol accumulator maintains a constant head of pressure (5.25 to 9 psia, depending on coolant level) at the inlets of the primary loop glycol pumps. Coolant temperature at the inlets is approximately +40° F. A switch in a low-level sensor trips when only 10±5% of coolant volume remains in the accumulator. When tripped, the switch provides a telemetry signal and causes the glycol caution light to go on.

The coolant is routed to the pumps through a filter. They are started by closing the appropriate circuit breakers and setting the glycol selector switch to pump 1 or pump 2. If the operating pump does not maintain a minimum differential pressure (ΔP) of 7±2 psi, the ΔP switch generates a signal to energize the ECS caution light and the glycol component caution light. Selecting the other pump deenergizes the lights when the onstream pump develops a minimum ΔP of 5.0 to 9.0 psi. If both pumps fail, the secondary loop is activated by setting the water tank selector valve to the secondary, setting the glycol pump switch to INST



EC-13

"ApolloNewsRef LM F.EC13.PICT" 414 KB 1999-02-04 dpi: 360h x 360v pix: 2671h x 3743v

APOLLO NEWS REFERENCE

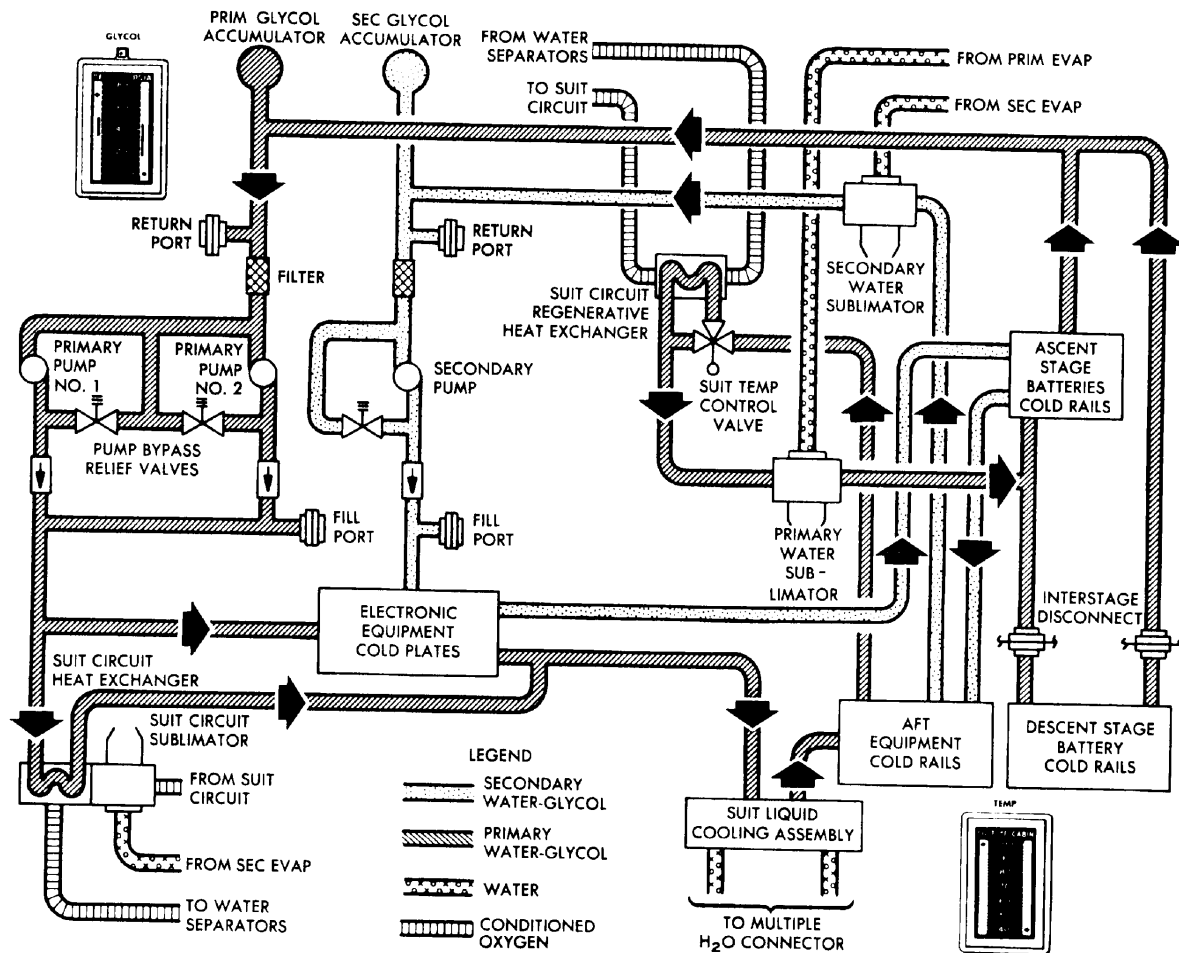

R-37

Heat Transport Section, Flow Diagram

(SEC), and closing the glycol pump secondary circuit breaker. Automatic transfer to primary pump No. 1 to primary pump No. 2 is initiated by closing the glycol automatic transfer circuit breaker and setting the selector switch to pump 1. When transfer is necessary, the caution lights go on, the transfer is accomplished, and the ECS caution light goes off. The glycol pump component light remains on.

If primary loop ΔP exceeds 33 psi, the pump bypass relief valve opens and routes the coolant back to the pump inlet, relieving the pressure. The valves start to open at 33 psi, are fully open at a

maximum of 39 psia, and reseal at a minimum of 32 psia. Check valves prevent coolant from feeding back through an inoperative primary pump.

Part of the coolant leaving the recirculation assembly flows to the suit circuit heat exchanger to cool the suit circuit gas of the ARS. The remainder of the coolant flows to the electronic equipment mounted on cold plates. The flow paths then converge and the coolant is directed to the liquid cooling garment water glycol heat exchanger to cool suit water as required. The coolant then flows through the aft equipment bay cold rails.

EC-14



APOLLO NEWS REFERENCE

A portion of the warmer coolant flow can be diverted to the suit circuit regenerative heat exchanger through the suit temperature control valve to increase suit inlet gas temperature. The diverted flow returning from the heat exchanger, combined with the bypassed coolant is routed to the primary sublimator.

The sublimator decreases the temperature of the coolant by rejecting heat to space through sublimation of water, followed by venting of generated steam through an overboard duct. Deflector plates, attached to the duct, prevent escaping steam from applying thrust to the vehicle. Water is fed to the sublimator at a pressure that exceeds 4.0 psia, but is less than 6.5 psia. The water pressure must be less than the suit circuit static pressure plus the head pressure from the water separators to the sublimator. The water regulators, referenced to suit circuit pressure, are in the water feed line to the sublimator. Regulated water pressure varies from 0.5 to 1.0 psid above suit circuit pressure. The sublimator inlet outlet temperatures are sensed by temperature transducers, which provide telemetry signals. Coolant from the sublimator flows through the ascent and descent battery cold rails, then returns to the recirculation assembly.

Two self-sealing disconnects upstream and downstream of the glycol pumps permit servicing of the HTS. Interstage disconnects are installed in coolant lines that connect to the descent stage. Before staging, coolant flows through the ascent and descent stage battery cold rails. After staging, the interstage disconnects separate, the lines are sealed by spring-loaded check valves, and the full coolant flow enters the ascent stage battery cold rails.

The secondary (emergency) coolant loop provides thermal control for those electronic assemblies and batteries whose performance is

necessary to effect a safe return to the CSM. Cooling is provided by the secondary sublimator.

As in the primary loop, a secondary glycol accumulator provides pressure for the pump inlet side and compensates for loss due to leakage. A pump bypass relief valve relieves excessive pressure by routing coolant back to the pump inlet. A check valve at the discharge side of the glycol pump prevents coolant flow from bypassing the HTS during GSE operation. The coolant from the pump passes through the check valve to the secondary passage of the cold plates and cold rails of the electronics and batteries cold plate section. Waste heat is absorbed by the coolant. The warm coolant then flows to the secondary sublimator.

The secondary sublimator operates in the same manner as the primary sublimator in the primary coolant loop. Water for the sublimator is provided when the secondary evaporator flow valve is opened. The coolant returns to the pump for recirculation.

Equipment essential for mission abort is mounted on cold plates and rails that have two independent coolant passages, one for the primary loop and one for the secondary loop.

PRIMARY COOLANT LOOP COLD PLATES AND RAILS

The cold plates and rails in the primary coolant loop are arranged in three groups: upstream electronics, aft equipment bay, and batteries.

Coolant from the recirculation assembly flows into parallel paths that serve the upstream electronics cold plate group. In this group, the data storage electronics assembly (DSEA) is cooled by cold rails; the remainder of the electronics, by cold

APOLLO NEWS REFERENCE

plates. The cold plates are in the pressurized and unpressurized areas of the LM. The flow rates through the parallel paths are controlled by flow restrictors, installed downstream of the cold plate group. The first upstream electronics flow path cools the suit circuit heat exchanger. The second flow path cools five cold plates mounted on the pressurized side of the equipment tunnel back wall. The third path serves the integrally cooled IMU and the rate gyro assembly (RGA) cold plate, both located in the unpressurized area (on the navigation base). The fourth path cools the abort sensor assembly (ASA) and pulse torque assembly (PTA) cold plates. All the plates for the fourth path are in the unpressurized area above the cabin; the ASA is on the navigation base of the alignment optical telescope (AOT). The fifth path serves the tracking light electronics (TLE), gimbal angle sequencing transformation assembly (GASTA), lighting control assembly (LCA), and DSEA plates: one in the unpressurized area in front of the cabin, a second one in the control and display panel area, a third one below the cabin floor, and another one on the left wall of the cabin.

The aft equipment bay is cooled by eight cold rails; the flow is in parallel. The batteries are cooled by cold rails. The ascent batteries are in the center section of the aft equipment bay; the descent batteries are in quads 1 and 4 of the descent stage. During the descent phase, the coolant flow is split between the descent batteries and the ascent batteries; the ascent batteries are not used during this time. When the stages are separated, quick-disconnects break the coolant lines and seal the ends; all coolant then flows through the ascent battery cold rails.

SECONDARY COOLANT LOOP COLD PLATES AND RAILS

The secondary coolant loop is for emergency use. Only cold plates and cold rails that have two independent passages (one for the primary loop and one for the secondary loop) are served by this loop.

In the upstream electronics area, the secondary coolant flow is split between three cold plates (RGA, ASA, and TLE) in parallel. The flow rate is controlled by a flow restrictor downstream of the TLE and RGA. After these three plates, the secondary loop cools the ascent battery cold rails and the aft equipment bay cold rails in a series-parallel arrangement. The coolant first flows through three ascent battery cold rails in parallel, then through eight aft equipment bay cold rails in parallel.

EQUIPMENT

ATMOSPHERE REVITALIZATION SECTION

SUIT CIRCUIT ASSEMBLY

Suit Circuit Relief Valve. The suit circuit relief valve protects the suit circuit against overpressurization. The valve has automatic, open, and close positions. Two externally mounted microswitches provide telemetry signals when the open or close position is selected.

In the automatic position, the valve responds to pressure sensed by the aneroid; it cracks open at approximately 4.3 psia to prevent overpressurization of the suit loop by allowing oxygen to flow to the cabin. At 4.7 psia, the valve is fully open and flows approximately 7.8 pph at +90° F. The valve reseats at approximately 4.3 psia. In the open position, the valve handle displaces the poppet from the seat to open the valve, regardless of pressure. In the close position, if the valve fails to reseal, the automatic poppet is left open, but an auxiliary poppet is closed, maintaining pressure.

Suit Gas Diverter Valve. The suit gas diverter valve is a manually operated, two-way valve (one inlet and two outlets) with a solenoid override in one direction. The valve is on the ECS package above the oxygen control module. When the valve handle is pushed into the cabin position, oxygen is directed into the cabin; pulling the valve handle to the egress position shuts off flow to the cabin.

APOLLO NEWS REFERENCE

An automatic closed-to-cabin feature is provided. If cabin pressure falls to below the normal level while the valve is set to CABIN, a solenoid is energized by the cabin pressure switch and the main spring returns the valve to the EGRESS position. Electrical power is also supplied to the diverter valve when the oxygen demand regulator valves are set to egress.

Cabin Gas Return Check Valve. The cabin gas return check valve is a spring-loaded, flapper-type valve. The valve has automatic, open, and egress (closed) positions. In the automatic position, the valve automatically permits cabin gas to return to the suit circuit. When the cabin is depressurized, the suit circuit pressure closes the valve, preventing backflow into the cabin. The open and egress positions provide manual override of the automatic position.

CO₂ Canister Selector Valve and CO₂ and Odor Removal Canisters. The CO₂ canister selector valve is a dual-flapper-type valve that routes flow through the CO₂ and odor removal canisters. The valve has primary and secondary positions. One flapper is at the inlet to the canisters; the other, at the outlet.

Each canister contains a cartridge filled with LiOH and activated charcoal. The primary canister cover has a debris trap, which may be replaced before, but not during, flight. A relief valve in the cartridge permits flow to bypass the debris trap if it becomes clogged. The canister selector valve is sufficiently leakproof to permit replacement of cartridges, with the cabin unpressurized.

Suit Circuit Fans. The suit circuit fans maintain the circulation of conditioned oxygen in the suit circuit. Each suit circuit fan is operated by a 28-volt d-c brushless motor, and each fan moves approximately 24 cfm at 25,000±500 rpm. Fan operation is controlled by the suit fan selector switch.

Suit Circuit Sublimator. The sublimator rejects suit circuit heat to space if the suit circuit heat exchanger is inoperative. It has a water inlet and a stream outlet that is vented overboard. Water and

suit circuit gas both make a single pass through the unit, which comprises a stack of modules of several layers of porous plates, water, steam, and suit circuit gas passages.

Suit Circuit Heat Exchanger. The suit circuit heat exchanger is a duct-shaped unit of aluminum plate-and-fin construction. It has a single pass for both the coolant and the suit circuit gas and is used to remove excess heat in the ARS. Heat is transferred to the HTS coolant supplied to the heat exchanger.

Water Separator Selector Valve. The water separator selector valve is a manually operated, flapper-type valve that enables selection of either of two water separators. The valve handle is pushed in for separator No. 1 and pulled for separator No. 2.

Water Separators. Two water separators are connected in parallel, but only one is used at a time. Saturated gas and free moisture fed into the separator come in contact with the inlet sensor blades, which direct the flow onto a rotor at the proper angle. Most of the entrained moisture collects on the rotating perforated plate, which centrifuges the water into a rotating water trough. A stationary pitot tube, picks up the removed water and discharges it to the WMS. The pitot pumping action creates a dynamic head of pressure sufficient to ensure positive flow from the water separator to the WMS. Water passing through the perforated plate collects on a rotating conical drum and is fed into the water trough. The oxygen flow drives the rotating parts of the separator. A water drain boss on each separator drains the cavity between the rotating drum and the outer shell of the unit. Plumbing attached to each drain boss carries water away from this area and dumps it into a surge (collection) tank outside the suit circuit.

Suit Circuit Regenerative Heat Exchanger. The suit circuit regenerative heat exchanger is of the aluminum plate and fin type. Heat from the circulating warm coolant is transferred to the oxygen, which makes a single pass through the unit while the coolant makes two passes.



EC-17

"ApolloNewsRef LM F.EC17.PICT" 390 KB 1999-02-04 dpi: 360h x 360v pix: 537h x 751v

APOLLO NEWS REFERENCE

Suit Temperature Control Valve. The suit temperature control valve is a manually operated diverter valve that controls coolant flow through the suit circuit regenerative heat exchanger. The valve has two positions, one to increase the temperature, the other to decrease the temperature.

Suit Isolation Valve. The suit isolation valve is a manually operated, two-position dual-ball valve. In the suit flow position, suit-circuit gas is directed through the valve into the PGA, and from the PGA back into the suit circuit. In the suit disconnect position, the valve keeps the gas in the suit circuit, by passing the PGA's and preventing flow in either direction between the suit circuit and PGA's.

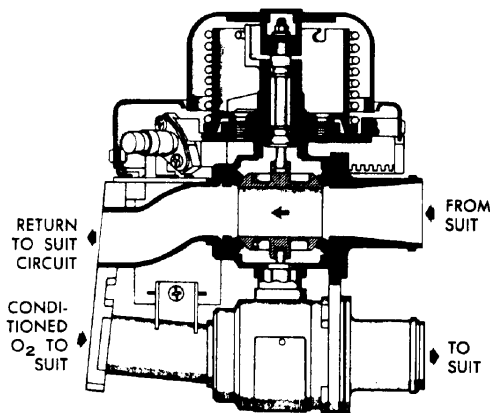
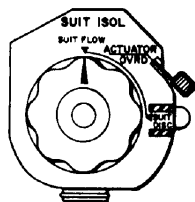

VALVE IN SUIT FLOW (OPEN) POSITION

R-38

Suit Isolation Valve

Setting the valve handle to suit flow loads a solenoid-operated spring return mechanism. A signal from the suit circuit pressure switch energizes the solenoid, releasing the return mechanism, which turns the valve to suit disconnect. The

ACTUATOR OVRD lever enables manual release of the return mechanism to the SUIT DISC position. A valve position indicator switch provides a telemetry signal for SUIT DISC position.

Carbon Dioxide Partial Pressure Sensor. The carbon dioxide partial pressure sensor, in the suit circuit assembly, is a single-beam, dual-wavelength, filter photometer with ratio readout. The sensor operates on the infrared-absorption principle. It measures the amount of infrared energy absorbed by the carbon dioxide in a gas sample that passes through the sensor, by comparing transmitted energy of two different wavelengths in the infrared spectrum. (One wavelength is absorbed by carbon dioxide; the other is a reference.) This establishes an amplified ratio signal that is indicated as a d-c voltage proportional to the partial pressure of carbon dioxide in the gas sample.

The sensor has two sections: optics and electronics. The optics section has the infrared energy source (a small tungsten lamp), a collimating lens, a lens that reimages the source on the dual filter, an aperture to fix the source image on the dual filter, and a lens that reimages the chopped and filtered source image onto the detector target. The electronics section detects and decodes the signal, computes the ratio and, then, reads out a continuous d-c voltage proportional to the partial pressure of carbon dioxide in the gas sample. The sensor provides an electrical signal to the PART PRESS CO₂ indicator and a telemetry signal to indicate the carbon dioxide level in the gas supplied to the astronauts.

SUIT LIQUID COOLING ASSEMBLY

Cabin Fan. The fan motor is of the brushless, d-c type; it operates on 28 volts dc with an input power of 62 watts average, 210 watts peak. The fan circulates cabin gas and can move approximately 5 pounds of air per minute at 13,000 rpm. The fan permits operation at sea level for checkout purposes. An input voltage of 15 volts dc is provided for this purpose.

Water-Glycol Heat Exchanger. The water glycol heat exchanger transfers heat from the warm water

EC-18



APOLLO NEWS REFERENCE

returning from the LCG to the coolant of the heat transport section. This heat exchanger is of the cross-counterflow, single-pass water and multipass coolant type.

Liquid Garment Cooling Valve. The liquid garment cooling valve is a manually operated diverter valve that controls water flow to the water-glycol heat exchanger. Part or all of the water may be manually diverted around the heat exchanger to provide varying degrees of cooling, depending on astronaut needs.

Water Accumulator. The water accumulator consists of an aluminum housing, diaphragm, spring, diaphragm piston guide, and diaphragm piston. The system water pressure opposes the spring action in the accumulator to maintain the correct pressure level in the water loop. The accumulator serves as a reservoir to make up for system leakage and volumetric changes due to temperature fluctuations.

Water Pump. The water pump is of the diaphragm type; it circulates water through the suit liquid cooling assembly. A voltage regulator steps down the LM-supplied 28 volts dc to 16 ± 1 volts dc for pump operation.

Portable Recharge Adapter. The portable recharge adapter serves as the connection between the PLSS drink line and the multiple water connector of the suit liquid cooling system. Bleed-off capability is provided in the adapter to relieve pressure in the event of overfilling of the system. Both astronauts are disconnected from the cooling system when recharging.

Suit Umbilical Water Hoses. The water umbilical hoses transport water between the LCG and the suit liquid cooling assembly. The hoses are flexible silicon rubber, covered with Beta cloth.

Multiple Water Connector. The multiple water connectors are quick disconnects that connect the water umbilical hoses to the LCG receptacle on the astronaut's outer suit. The connectors provide dual flow into, and out of, the LCG. Poppet valves minimize leakage during connecting and disconnecting.

OXYGEN SUPPLY AND CABIN PRESSURE CONTROL SECTION

DESCENT OXYGEN TANK

The descent oxygen tank is in quad 3 of the descent stage. The tank holds 48.01 pounds of oxygen, stored at a pressure of 2,850 psia. The tank provides six PLSS refills at 0.92 pounds each and four cabin repressurizations at 6.6 pounds each. The tank is filled through a high-pressure fill port, which is capped and lockwired before launch.

HIGH-PRESSURE OXYGEN CONTROL ASSEMBLY

The major components of the high-pressure oxygen control assembly are a high-pressure oxygen regulator, a bypass oxygen pressure relief valve, an overboard relief valve, and a burst diaphragm assembly.

High-Pressure Oxygen Regulator. The internally series redundant high-pressure oxygen regulator receives high-pressure oxygen from the descent oxygen tank and regulates the pressure to 875 to 960 psia. If the upstream (primary) regulator sensor fails, the valve fails open, permitting the downstream (secondary) regulator to control outlet pressure. Descent oxygen that enters the regulator is sensed by the primary sensor. As the pressure builds up inside the sensor, it expands and allows the primary valve poppet to move towards its seat, regulating the outlet pressure to the secondary regulator. The secondary regulator operates the same as the primary regulator.

Bypass Oxygen Pressure Relief Valve. The bypass oxygen pressure relief valve protects the descent oxygen tank against overpressurization by bypassing the high-pressure oxygen regulator. The valve is designed to fail in the open condition if it malfunctions. If the relief valve malfunctions (bellows ruptures), the valve is automatically placed in the failed-open condition, bypassing the oxygen to a secondary (identical) relief valve.

Overboard Relief Valve. The series-redundant overboard relief valve vents oxygen to ambient when



EC-19

"ApolloNewsRef LM F.EC19.PICT" 390 KB 1999-02-04 dpi: 360h x 360v pix: 541h x 753v

APOLLO NEWS REFERENCE

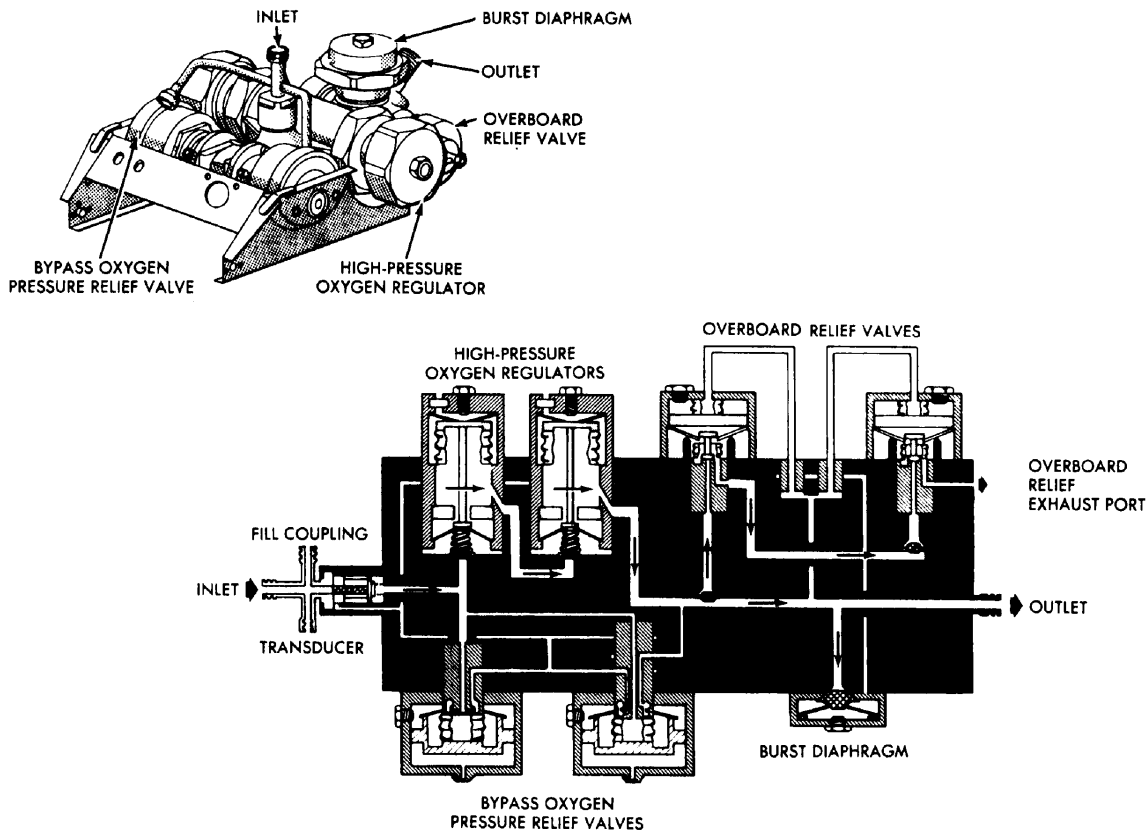

High Pressure Oxygen Control Assembly

R-39

the pressure downstream of the high-pressure oxygen regulator reaches 1,025 psig. The valve is fully open at 1,090 psig and reseats at 985 psig at +75° F. The relief valve has a fail-open feature. If a capsule sensing element leaks, the oxygen is dumped into the leakage chamber and bleeds overboard.

Burst Diaphragm Assembly. The burst diaphragm assembly opens when the flow from the descent oxygen tank exceeds the relieving capability of the overboard relief valve. An aluminum disk in the inlet port of the burst diaphragm assembly ruptures at a system pressure between 1,300 and 1,400 psig. System pressure causes the diaphragm support to move away from the disk, causing it to rupture. The disk support poppet opens and vents the descent oxygen tank. The diaphragm assembly permits a minimum flow of approximately 10 pounds per minute. When descent tank pressure is

reduced to 1,000 psia, the disk support poppet reseats to maintain sufficient oxygen for one cabin repressurization up to 1 hour after disk rupture.

ASCENT OXYGEN TANKS

Two identical tanks supply all the oxygen required for metabolic consumption and to compensate for cabin and/or suit circuit leakage, oxygen component leakage, subsequent to switch-over to ascent consumables. Both tanks are in the aft equipment bay. Oxygen flow from either tank is controlled by individual oxygen shutoff valves on the oxygen control module.

OXYGEN CONTROL MODULE

The oxygen control module is mounted on the suit circuit package located to the right rear of the LM Pilot's station. It contains filters, a PLSS oxy-

EC-20



APOLLO NEWS REFERENCE

gen shutoff valve, descent and ascent oxygen shutoff valves, oxygen demand regulators, and a cabin repressurization and emergency oxygen valve. An interlock prevents opening the ascent oxygen shutoff valves until the descent oxygen shutoff valve is closed. Filters at the inlets to the oxygen control module and the PLSS disconnect remove particulate matter from the oxygen. Filtering capability is 18 microns nominal and 40 microns absolute.

PLSS and Oxygen Tank Shutoff Valves. Four positive-action, manually operated shutoff valves control oxygen flow into the oxygen control module. Rotating the valve handle to the open position displaces a spring-loaded seal. The valves have detents in the open and closed positions; mechanical stops on the handle prevent overtravel.

Oxygen Demand Regulators. Two, parallel oxygen demand regulators regulate oxygen from the tanks to the suit circuit. Both regulators are manually controlled by individual four-position selector handles. Suit circuit pressure is fed back to an aneroid bellows that actuates a poppet. Rotating the valve handle to cabin or egress position changes the spring force acting on the poppet and establishes two outlet pressure levels. Selecting the direct O₂ position, fully opens the valve. With an upstream pressure of 900 psia and a temperature of +70° F, one regulator can flow approximately 7.0 pounds per hour into the suit circuit. In the closed position, an auxiliary poppet stops all flow through the regulator. Each regulator has valve position indicator (VPI) switches, and two functional switches that control electrical circuits in the ECS.

Cabin Repressurization and Emergency Oxygen Valve. The cabin repressurization and emergency oxygen valve is a solenoid-operated valve with manual override. It is used to repressurize the cabin after a deliberate decompression and provides an emergency flow of oxygen if the cabin is punctured. If the cabin is punctured and the diameter of the hole does not exceed 0.5 inch, the valve can maintain cabin pressure at 3.5 psia for at least 2 minutes, allowing the astronauts to return to a closed-suit environment. The cabin repressurization and emergency oxygen valve is controlled by a three-position handle on the oxygen control module.

When the automatic position is selected, valve operation is controlled by the solenoid, which is actuated by the cabin pressure switch. If either oxygen demand regulator is set to cabin or direct O₂ positions and cabin pressure drops below normal, the cabin pressure switch energizes the solenoid. This moves the valve yoke to open the inlet valve and permits oxygen from the oxygen manifold to flow through the valve into the cabin. If cabin pressure increases to normal, the cabin pressure switch deenergizes the solenoid and spring action closes the valve. Setting both oxygen demand regulators to the close or egress positions disables the circuitry to the solenoid through the cabin pressure switch, provided suit pressure does not drop below 3.12 psia. When supplied by the descent GOX tank, flow is 4 pounds per minute maximum; when supplied by the ascent tank, 8 pounds per minute at 700 psia. When the manual position is selected, the handle shaft actuates a cam that moves the yoke to open the inlet valve and establish flow to the cabin. In the close position an auxiliary poppet is forced onto its seat, shutting off the flow.

CABIN RELIEF AND DUMP VALVES

A cabin relief and dump valve is installed in each hatch. The valve is a differential-pressure, servo-actuated poppet valve that prevents cabin overpressurization and permits manual dumping of cabin pressure. Each valve is controlled with either of two handles: one, inside the cabin; the other, outside. The inside handles can be used to select three positions (dump, automatic, or closed). The outside handles have only a dump position. A bacteria filter mounts on the forward cabin relief and dump valve.

Normally, the cabin relief and dump valves are set to the automatic position. In this position, the valves are operated by the servo valve. When the cabin-to-ambient pressure differential reaches approximately 5.4 psi, oxygen is vented overboard and cabin pressure is reduced to an acceptable value. When the pressure differential is 5.8 psi, one fully open dump valve can dump 11.1 pounds of oxygen per minute overboard. When the valve handle inside the cabin is set to the automatic position, the valve can be opened manually from outside.



EC-21

"ApolloNewsRef LM F.EC21.PICT" 444 KB 1999-02-04 dpi: 360h x 360v pix: 2658h x 3749v

APOLLO NEWS REFERENCE

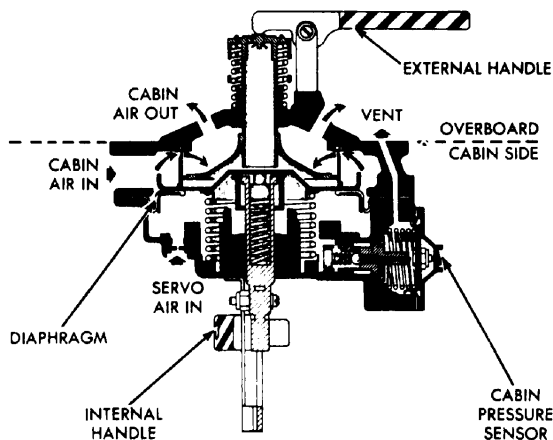
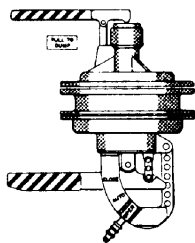

R-40

Cabin Relief and Dump Valve

Setting the internal handle to the dump position unseats the poppet. The valve in the overhead hatch can dump cabin pressure from 5.0 to 0.08 psia in 180 seconds without cabin oxygen inflow; the forward hatch valve (with filter) in 310 seconds. Setting the handle to the closed position prevents the valve from opening at normal pressures, if the servo valve fails.

The oxygen bacterial filter on the cabin side of the forward cabin relief and dump valve removes bacteria from the dumped cabin oxygen. The filter can be installed and removed by an astronaut in the cabin. It removes 95% of all bacteria larger than 0.5 micron.

CABIN PRESSURE SWITCH

The cabin pressure switch monitors cabin pressure and enables electrical signals to control related ECS functions. The switch is an absolute-pressure

device that consists of three separate hermetically sealed microswitch capsules. The capsules are set to cause switch closure when cabin pressure decays to 3.7 to 4.45 psia during pressurized-cabin operation. If this occurs with either oxygen demand regulator in cabin mode, the suit gas diverter valve closes, the cabin repressurization and emergency oxygen valve opens, and the cabin warning light goes on. Increasing cabin pressure to 4.40 to 5.0 psia opens the cabin pressure switch circuits, closes the cabin repressurization and emergency oxygen valve, and deenergizes the cabin warning light.

WATER MANAGEMENT SECTION

DESCENT STAGE WATER TANK

The descent stage water tank is an aluminum tank with an internally mounted standpipe and bladder. The bladder contains the water; the space between the bladder is charged with nitrogen according to a schedule dependent on the load (48.2 psia maximum at +80° F). The nitrogen squeezes the water out of the bladder through the standpipe and into the system. The tank outlet is connected to the water control module. Water from the descent water tank is routed through the water tank select valve by setting it to the descent position.

Descent Water Valve. The descent water (DES H₂O) valve is a manually operated, poppet-type shutoff valve. The valve has open and closed positions. In the open position, the valve provides high-pressure water flow from the descent tank to the water dispenser.

ASCENT STAGE WATER TANKS

The ascent stage water tanks are in the overhead unpressurized portion of the cabin. They are similar to the descent stage water tank, but are smaller. An initial nitrogen charge of 48.2 psia at +80° F is used in each tank. The tank outlets are connected to the water control module. Water from the ascent water tanks is routed through the water tank selector valve by setting it to the ascent position.

EC-22



APOLLO NEWS REFERENCE

Ascent Water Valve. The ascent water valve, at the top of the water control module, is a manually operated, poppet-type shutoff valve. The valve has open and closed positions. In the open position, the valve provides high-pressure water flow from the ascent tank to the water dispenser.

the pressure/temperature ratio from a set constant voltage, which represents the total volume of the tank. The result, tank volume minus gas volume, is water volume.

WATER QUANTITY MEASURING DEVICE

A water quantity measuring device (WQMD) for each of the three water tanks measures the quantity of water in the tank. The analog voltage output of the WQMD is fed to the quantity indicator and is displayed on the H₂O scale as the percentage of water remaining in the tanks.

WATER CONTROL MODULE

The manual controls of the WMS are grouped together on the water control module. The module consists of check valves, shutoff valves, a water tank selector valve, and water pressure regulators. Each water tank outlet is connected to the module, which diverts the water to selected flow paths.

The WQMD measures the quantity of water by sensing the pressure/temperature ratio of the tank pressurizing gas. This ratio decreases as the gas expands in expelling the water. An analog computer subtracts a voltage inversely proportional to

Check Valves. There are five check valves in the water control module: one in each tank feed line, and one in each discharge line from the ARS water separators. The check valves prevent water flow from the module to the water tanks and water separators.

Water Tank Selector Valve. The water tank selector

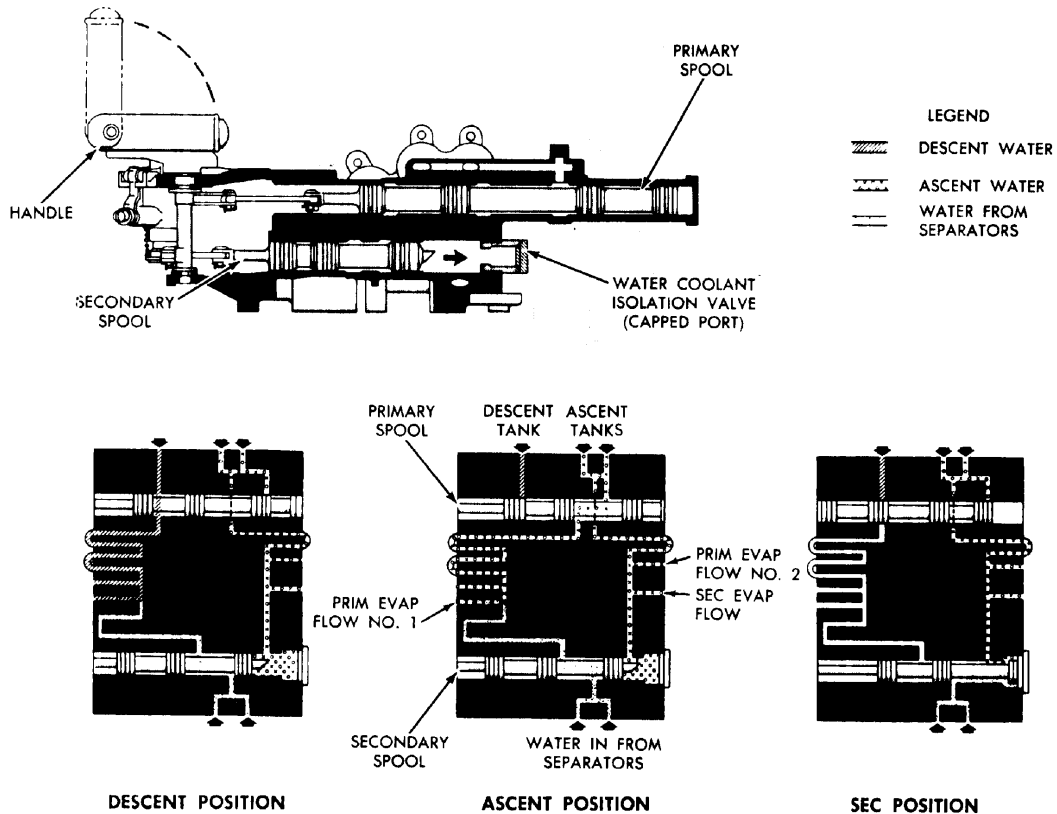

R-41

Water Tank Selector Valve



EC-23

APOLLO NEWS REFERENCE

valve is a manually operated, three-position, two-spool valve. The two spools (primary and secondary), linked to the valve handle, rearrange the internal ports to establish proper flow paths. The valve has descent, ascent, and secondary positions. In the descent position, the primary spool establishes a flow path between the descent water tank and the primary water manifold. In the ascent position, the primary spool establishes a flow path between the ascent tanks and the primary water manifold. When the valve is in the secondary position, flow is diverted from the ARS separator to the secondary manifold and water is routed from the ascent water tanks to the secondary manifold.

Water Pressure Regulators. Three water pressure regulators are in the WMS. Two are in series in the primary manifold and in the secondary manifold, and one is located external to the water module in the water pressure regulator module. The regulators contain a spring-loaded diaphragm that senses the differential between ARS reference pressure and the downstream water pressure. The diaphragm moves a balanced lever attached to a metering poppet. The water discharge pressure is maintained at 0.5 to 1.0 psi above the reference pressure.

Primary Evaporator Flow Valve No. 1. The primary evaporator flow No. 1 valve is a manually operated, poppet-type shutoff valve. It has open and closed positions. In the open position, the valve allows flow from the ascent or descent water tanks, through the primary regulators, to the primary sublimator.

Primary Evaporator Flow Valve No. 2. The primary evaporator flow No. 2 valve is a manually operated, poppet-type shutoff valve. It has open and closed positions. In the open position, the valve acts as a backup to the primary evaporator flow valve to provide ascent tank water from the secondary water manifold to the primary sublimator.

Secondary Evaporator Flow Valve. The secondary evaporator flow valve is a manually operated, poppet-type shutoff valve. It has open and close positions. The valve controls water flow from the secondary water manifold to the secondary sublimator and to the suit circuit sublimator.

Water Pressure Regulator Module. The water pressure regulator module consists of a pressure regulator and a manifold. The module is located in the secondary water circuit, downstream and in series with the secondary water pressure regulator in the water control module.

HEAT TRANSPORT SECTION**COOLANT ACCUMULATOR**

There are two accumulators, one in the primary loop and an identical one in the secondary loop. The coolant accumulator consists of a two-piece aluminum cylinder that contains a movable spring-loaded piston bonded to a diaphragm. The fluid side contains approximately 46 cubic inches of fluid under pressure. The pressure varies, directly with fluid level, from 5.6 psia at 5% level to 8.0 psia at 80% level. The accumulator maintains a head of pressure on the glycol pump inlets to prevent pump cavitation and replaces coolant lost through subsystem leakage. The piston moves in response to volumetric changes caused by temperature variations in the primary loop or by leakage. The accumulator spring side is vented to space.

The accumulator has a low-level sensor with a switch that trips when only $10 \pm 5\%$ of the coolant volume remains. The switch is mounted on top of the accumulator. A tube extending from the top of the accumulator, houses a rod attached to the piston. The switch provides a telemetry signal.

PRIMARY COOLANT FILTER

The primary coolant filter has a filtering capability of 35 microns. It has an integral pressure relief bypass feature that opens at 0.27 to 0.4 psid to maintain coolant flow to the pumps if the filter becomes clogged.

COOLANT PUMP

The three coolant pumps are identical. Two pumps are connected in the primary loop; the third pump, in the secondary loop. The pumps are of the sliding-vane, positive-displacement type; they are driven by 28-volt d-c brushless motors. The motors are of wet or submerged design and are cooled by

APOLLO NEWS REFERENCE

the recirculating coolant. The pump speeds will vary with changes in coolant temperatures and pump input voltages. As a result, system coolant flow rates may vary from 4.2 to 5.4 pounds per hour causing primary pump pressure rise of 12 to 25 psi and secondary pump pressure rise of 8 to 18 psi.

SUIT TEMPERATURE CONTROL VALVE

The suit temperature control valve is a manually operated diverter valve. The amount of warm coolant flowing through the suit circuit regenerative heat exchanger is regulated by the handle, which can be turned from hot to cold.

SUBLIMATORS

The porous-plate-type sublimators (one in the primary loop and another in the secondary loop) are identical, except that the primary sublimator has a larger capacity. Each sublimator has a coolant inlet and outlet, a water inlet, and a steam outlet. Water makes one pass through the unit; coolant makes six passes through the primary sublimator and four passes through the secondary sublimator. For proper sublimator operation, water pressure must exceed 4.0 psia, but be less than 6.5 psia. The water pressure must also be less than the suit circuit static pressure plus the head pressure from the water separators to the sublimator.

The unit rejects heat to space by sublimation of ice. Water from the WMS flows through the water passages, into the porous plates, and is exposed to space environment. The vacuum pressure is below the triple point of water; this causes an ice layer to develop within the pores and on the inner surface of the plates. As the hot coolant flows through the sublimator passages, heat transfers from the coolant to the water and to the ice layer. The ice sublimates from the solid state to steam without passing through a liquid state, rejecting its heat

load overboard through a duct. The thickness of the ice layer varies with the heat load imposed on the sublimator, resulting in a regulated output temperature over a range of input temperatures.

COLD PLATES AND RAILS

Electronic equipment that requires active temperature control is cooled by cold plates and cold rails. Most flat cold plates are installed between electronic equipment and the LM structure in a manner that minimizes heat transfer from the structure to the coolant, to avoid a reduction of the coolant cooling capacity. The surrounding structure and equipment may have a temperature range of 0° to +160° F. The remaining flat cold plates are installed directly on the electronic equipment without making contact with the LM structure. Cold rails are also structural members and are used in the aft equipment bay in the descent stage for the DSEA. The IMU has an integral cooling circuit. Cold plates and cold rails for equipment essential for mission abort have two independent coolant passages, one for the primary loop and one for the secondary loop.

The flat cold plates are brazed assemblies with inlet and outlet fittings. The coolant flows between two parallel sheets, which are connected by fins for increased heat transfer and structural strength. The internal fin arrangement of these cold plates ensures sufficient flow distribution.

The cold rails are channel-and-tube-type extrusions; the tubular part forms the inside center of the channel. The tube has fins and, at the ends, coolant inlet and outlet fittings. The cold rails are installed in parallel arrangement, with equal space between the rails to accommodate equipment designed for mounting on cold rails. Each cold rail (except the first and the last one) cools two adjacent rows of equipment.



EC-25

"ApolloNewsRef LM F.EC25.PICT" 354 KB 1999-02-04 dpi: 360h x 360v pix: 2650h x 3742v

NASA Apollo Lunar Module (LM) News Reference (1968)

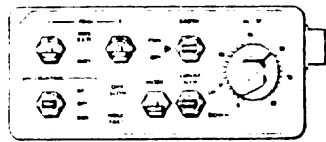
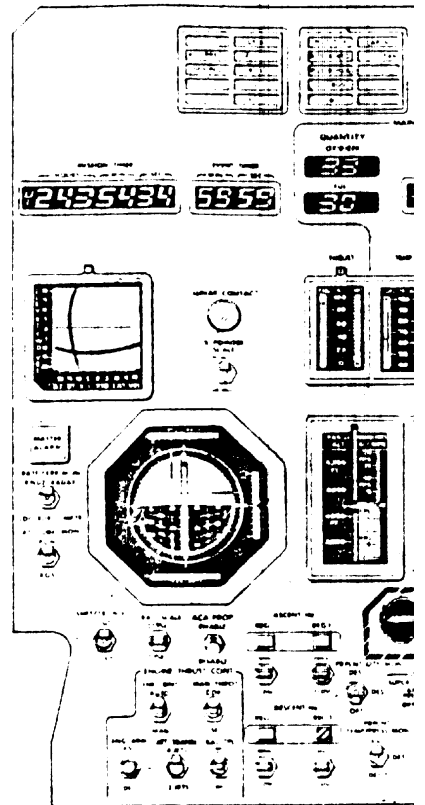
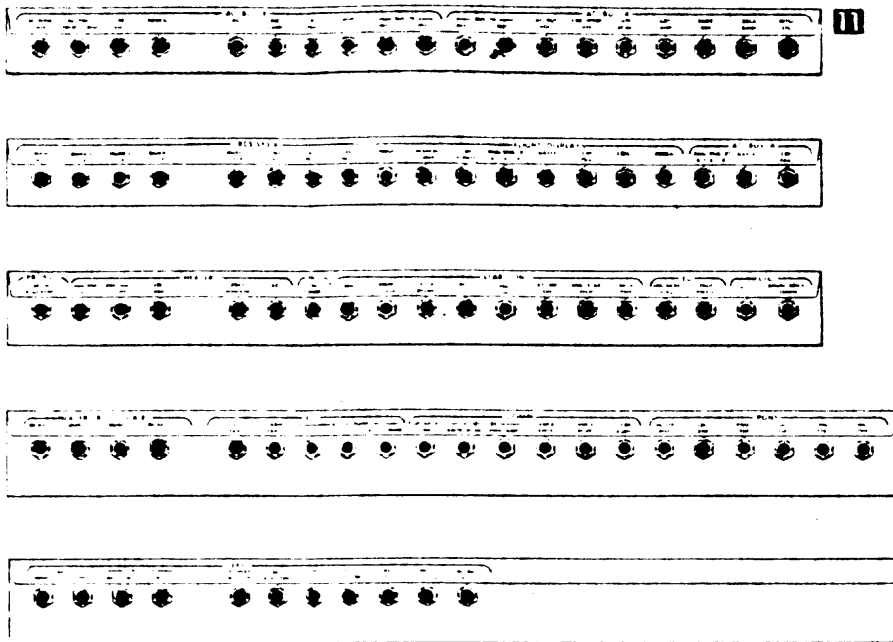

ORBITAL RATE DISPLAY – EARTH AND LUNAR (ORDEAL)

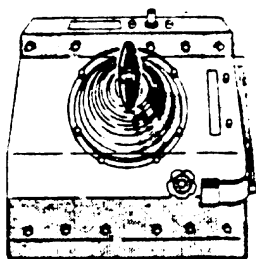
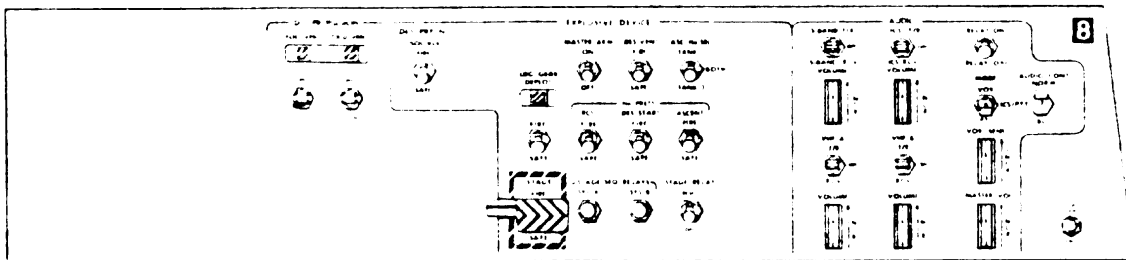
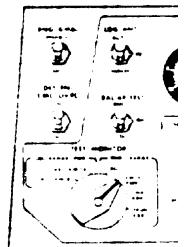

THRUST/TRANSLATION CONTROLLER ASSEMBLY (TTCA)

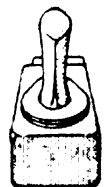
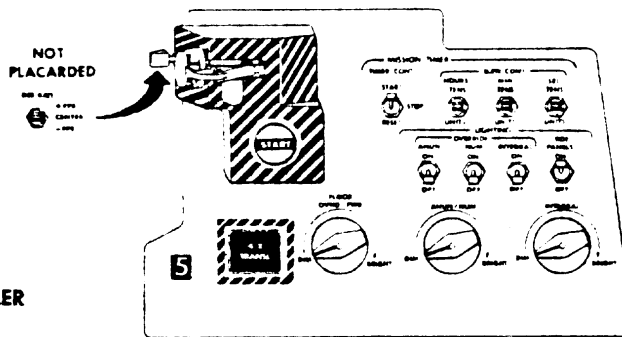

ATTITUDE CONTROL ASSEMBLY (ACA)

APOL

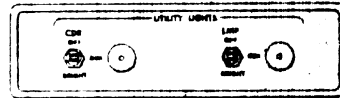
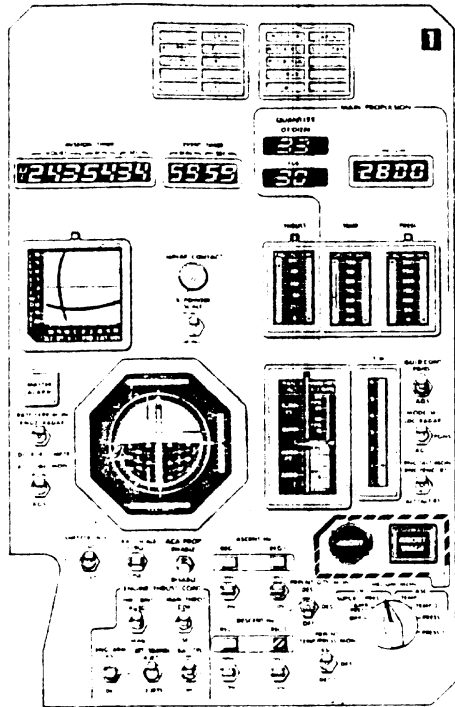
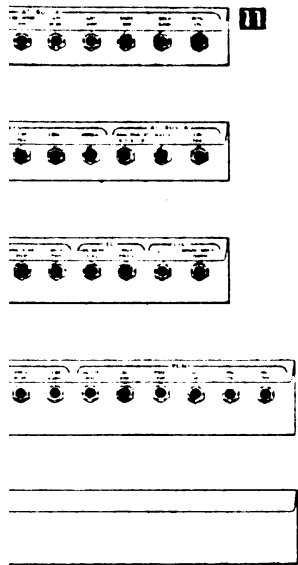

UTILITY LIGHT SWITCH ASSEMBLY

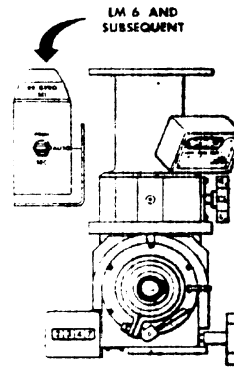

ALIGNMENT OPTICAL TELESCOPE (AOT)

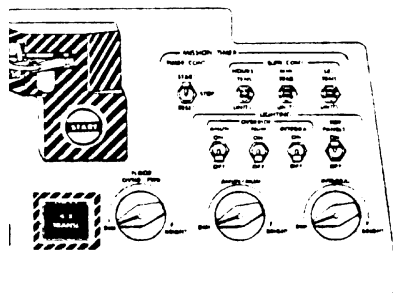
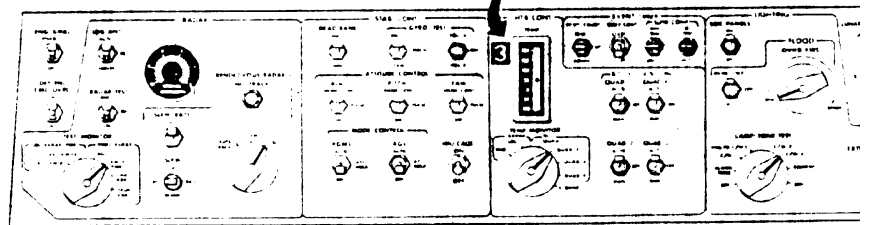
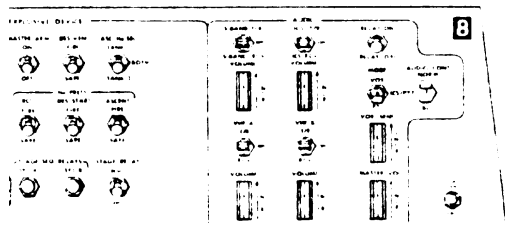
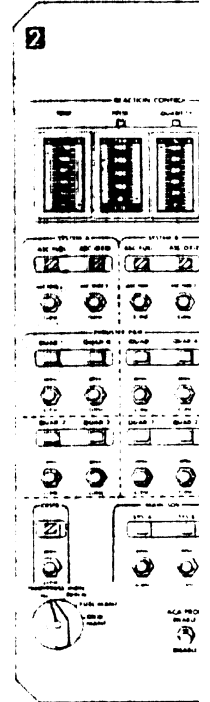

ATTITUDE CONTROLLER ASSEMBLY (ACA)

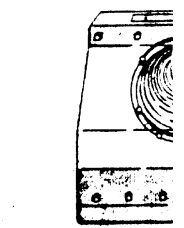
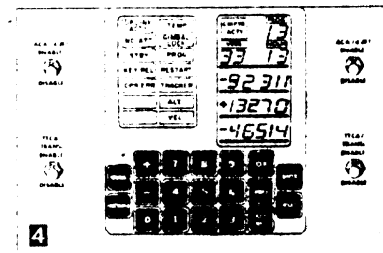

THRUST/TRANSLA ASSEMB

APOLLO NEWS REFERENCE

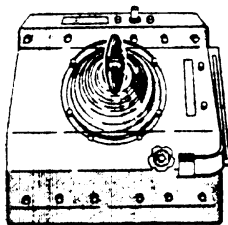
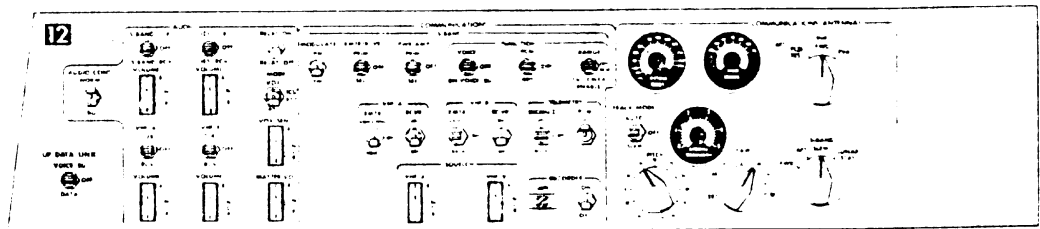
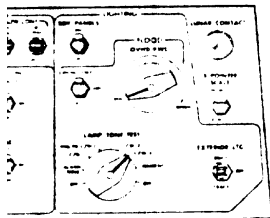
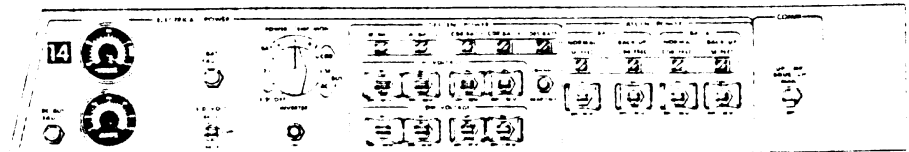
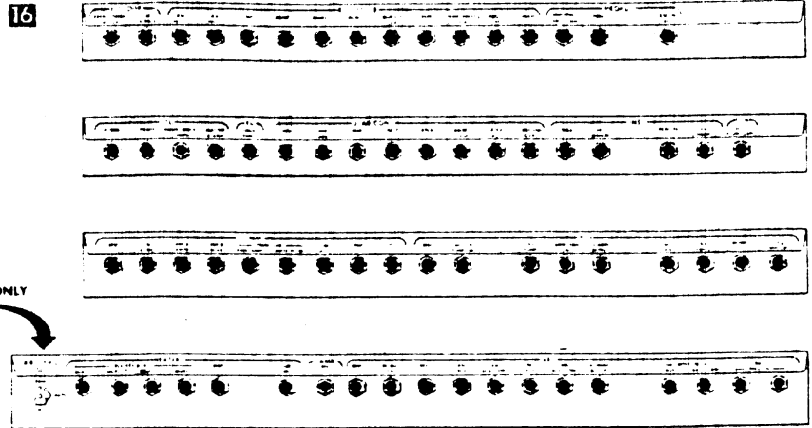
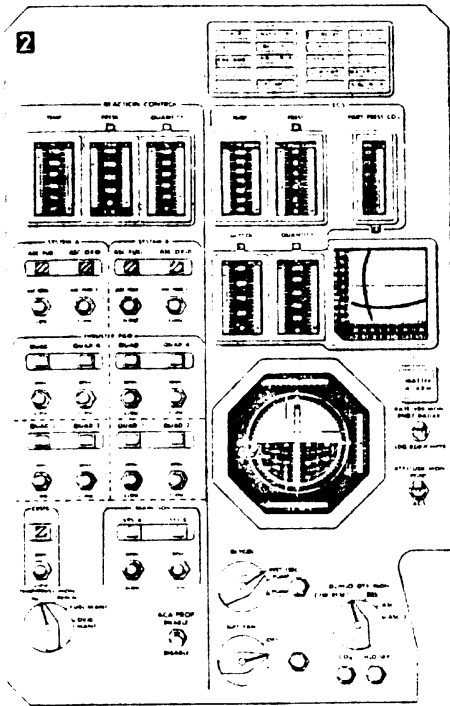

THRUST/TRANSLATION CONTROLLER ASSEMBLY (TTCA)

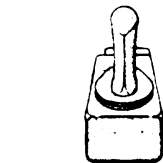
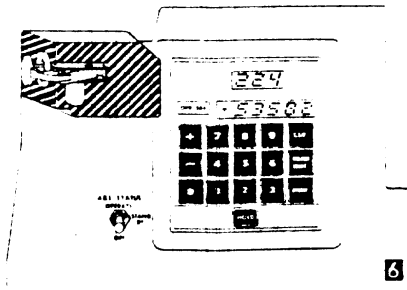

ATTITUDE CONTROLLER ASSEMBLY (ACA)

Lunar Module Controls and Displays

R-43



CD-3